

NATIONAL CONFERENCE

on
**Current Trends in
Engineering, Science and Technology**

NACCTEST-2018

20th March, 2018



in association with...



*The Indian Society
for Technical
Education (ISTE)*



*Godavari
Foundation,
Jalgaon*



*International Journal of
Innovations in Engineering &
Science (IJIES) ISSN: 2456-3463*



Estd. 1999

Organized By :

Godavari Foundation's

GODAVARI COLLEGE OF ENGINEERING

P-51, Dr. Ulhas Patil Nagar, M-Sect., Addl. M.I.D.C.,
Bhusawal Road, Jalgaon - 425 003.

Tel.: 0257-2213500, 2270451, 2212999

visit us : www.godavaricoejal.ac.in

A Tradition of Excellence !

Contents

Electronics & Telecommunication (E&TC)

SL No:	Paper ID	Paper Title	Author (s)	Page No.
1	E&TC-01	Investigation of Microstrip Circular Patch Antenna and Step Discontinuities in Feed Line	Dr.Tarun kumar Kanade Prof. Maheshkumar A. Pardesi ,Vijay D. Chaudhari Dr. Anil J. Patil, Dr. S. B. Deosarkar	1
2	E&TC-02	Intelligent Medicine Tray for ICUs in Hospitals: A Literature Review	Prajakta M. Borse, Ishwar S. Jadhav, Vijay D. Chaudhari H. T. Ingale	5
3	E&TC-03	Survey on Printed Antenna for Wireless Communication	Aditi A. Patil, Dipali N. Bharambe, Chetashri A. Jawale, R. V. Patil Mahesh N. Patil	9
4	E&TC-04	A Survey on Various Traffic Management Schemes for Traffic Clearance and Emergency Vehicles	Niketa P. Chaudhari,Vijay D. Chaudhari,Dr. A. J. Patil, Hemraj V. Dhande	13
5	E&TC-05	PLC Based Automatic Car Washing.	Deepak S. Mali ,Hitesh M. Wankhade , Tushar S. Ragde , A. D.Vishwakarma , Vijay Chaudhari .	19
6	E&TC-06	Edge Mesh: A New Paradigm to Enable Distributed Intelligence in Internet of Things	Amrita Singh,Vijay D. Chaudhari, A. D. Vishwakarma, D.P.Marathe	22
7	E&TC-07	Survey On Fractal Antenna For Wireless Communication	Sarika Borle, Shradhha Patil, Vipul Karankar, M.N.Patil, Vijay D. Chaudhari	27
8	E&TC-08	Energy Efficient Home Automation Based on IoT Using Arduino Application	Venkat P. Patil , Umakant Bhaskar Gohatre, Mandar N. Bodane, Abhishek Ramakrishnan	29

9	E&TC-09	Development of Real Time Performance Evolution in Moving Object Identification Approach for Higher Foreground Deep Detection Features	Umakant Bhaskarrao Gohatre, Venkat P. Patil, C. Ram Singla	35
10	E&TC-10	Solar Parameter Simulation	Supriya Baviskar, Annapurna Marathe, Pooja Desale, Hemant T. Ingale, Vijay. D. Chaudhari, D. P. Marathe	41
11	E&TC-11	Electromagnetic Interference Improvement In Electronics Circuits	Rahul R. Deore, Yashwant A. Mahajan, Syd Juned Ali, Vijay D. Chaudhari, Dr. S. B. Deosarkar, D. P. Marathe	46
12	E&TC-12	Review Paper On Detection Of Diseases Of Eyes Using Soft Computing Technique	Bansode Balbhim Narha Dr.Ajij Sayyad Dr.Bakwad K.M. Dr. CH. Vidyasagar	51
13	E&TC-13	A Survey on Speaker Identification System	Leena S. Patil, Vishal B. Patil, Varsha P. Patil, Nikita S. Khachane, Hemraj V. Dhande	60
14	E&TC-14	Survey Paper on Bimodel Biometric Authentication System	Machhindra R. Javare, Utkarsha A. Chaudhari, Sandeepkumar Nishad, R. V. Patil, Ansari Shafique	65
15	E&TC-15	Biometric Authentication By Using Face Recognition	Parmeshwar V. Wagh, Harshal R. Patil , Siddheshwar S. Tambare, I. S. Jadhav ,D.P.Marathe	68
16	E&TC-16	Literature Survey OF Industrial Monitoring & Fault Detection	Ketan Pralhad Jadhav, H. T. Ingale, V. D.Chaudhari, S.K.Chaudhari	72
17	E&TC-17	Literature Survey On Robotics In Medical Field	Roshani Sonar, Hemraj V. Dhande, R. V. Patil	77

			H.T.Ingale, Vijay V. Chaudhary	
18	E&TC-18	Study Of CAN Bus In Autonomous Of All Terrain Vehicle	Jagruti Wagh, R. V. Patil, I. S. Jadhav, Shaffique Ansari, A. D.Vishwakarma	83
19	E&TC-19	Nano Structured Solar Cell	Kanchan R. Mangrule, H. T. Ingale ² , S. K. Chaudhari, V.D.Chaudhari, M. N. Patil	90
20	E&TC-20	Comprehensive Survey on Thermal Challenges In Electronics Circuits	Jyoti Sapkale, Vijay D. Chaudhari, M. N. Patil , Prashant L Paikrao, Dr. A. J. Patil	99
21	E&TC-21	Smart Weighing Scales in Shopping Malls: A Critical Review	Sunil Khangal, I.S.Jadhav, V. D. Chaudhari, Shafique Ansari, H. V. Dhande, D. P. Marathe	109
22	E&TC-22	Thermal Imaging in Electronics: A Review	Ketali Patil, A. D. Vishwakarma, Shafique Ansari, D. P. Marathe, B. N. Bansode	118
23	E&TC-23	A Survey of Advertising & Digital Marketing on performance of Indian Telecomm Companies	Ulka Nehete, Pallavi Nehete, Vijay D. Chaudhari, Vilas U Ubale	123

Computer Science & Engineering (CSE)

1	CSE-01	Public Cloud For Academic Stuff	Reshma Attarade, Chetna Savdekar, Jagruti Badgujar, Kartik Malviya, Prof.Pramod B.Gosavi	128
2	CSE-02	Survey on a Secure Health Care Technology Based on BSD Care	Rajshri Surdas, Mayuri Kathade, Rupali Borole, Kalyani Bagul, Prof. NileshChoudhry	132
3	CSE-03	Android Based Smart Attendance System	Miss. Madhuri Zawar Vishakha Dandage,	139

			Yogita Pati , Ashwini Mahajan, Shubhangi Sapkal	
4	CSE-04	ACADEMIC TEACHING PLAN	Miss. Rupal More, Disha Jamdade, Varsha Patil, Suvarna Patil, Prathmesh Joshi	144
5	CSE-05	STUDENT INFORMATION MANAGEMENT SYSTEM	N.S.Vani, P.R.Patil, A.D.Vadnere, A.S.Patil , R.M.Shaikh, L.B.Ghate	149
6	CSE-06	ACTIVE ZIGBEE AND GPS BASED PRECISE DEVICE TRACKING SYSTEM	Mr. Prasad Rajendra Joshi	155
7	CSE-07	Medical Imaging using Deep Learning	Jayashri J. Patil. Mr. Rahul Gaikwad	164
8	CSE-08	Software for Training and Placement	Ganesh Chavan, Supriya Pawar, Rahul Patil, Abhishek Somwanshi, Roshni Patil	169
9	CSE-09	Campus Navigation Android Application	Iqbal S. Malik , Kinjal Mali, Bhushan Barapatre, Minal Pawar, Mr. Rahul Gaikwad	174
10	CSE-10	Improved Data Mining Based Prediction of User Behavior through Sessions	Mr Tushar Kolhe, Mr Nilesh Choudhary, Mr Ashfaque Shaikh Rafique	179
11	CSE-11	Survey on Predicting Instructor Performance using Data Mining Technique	Ms Priya s. Patil Mr Nilesh Choudhary Ms Renuka Deshpande	186
12	CSE-12	Analysis of Multiple Link Failures in MPLS Network	MS Pranita Shankhpal Mr. Rahul Gaikwad	190
13	CSE-13	Blockchain Technology- A Survey	Ms Poonam P Patil , Mr. Rahul Gaikwad	197
14	CSE-14	Android Based Waste Food Management Using Sustainable Food Prevention Strategies	Ms. Ashwini Ahirrao Ms Shital Patil Kanchan Mali Kajal Patil Priya Patil Ashfaque Shaikh	203

15	CSE-15	A Review on Retinex based Image Enhancement Techniques	Ms Priyanka B. Waghmode Mr. Nilesh Vani	208
16	CSE-16	Priority based Algorithm for Automatic Question Paper Generation	Mr.Aditya p Kulkarni ¹ Mr.Mayur Kakade Mr. Shaikh Ashfaque	214
17	CSE-17	Finger Matching Using Ratio Of Relational Distances & point Matching	Mr Anil K.Jain ¹ Ms Tasneem Bakerywala Rahul Gaikwad Pramod Gosavi	218
18	CSE-18	Internet of Robotics Things	Ms Ashwini B. Lokhande Prof. Rahul Gaikwad	226
19	CSE-19	Computer and Network Security	Prof. Vasanti U. Mahajan Prof. Pooja S. Dani, Prof. Rais Khan	231

Mechanical Engineering (ME)

1	ME-01	Reliability of Mathematical model in Cupola Furnace	Hemant R. Bhagat Dr.V. G. Arajpure	233
2	ME-02	Resolved Issues of Dew Point in Hydrogen Dryer and Improving the Performance of Generator	H. G. Patil R.P. Kale A.S.Kamadi	243
3	ME-03	Improving the efficiency of Boiler Feed Pump by modification of Recirculation Valve Plug and Seat Ring	H. G. Patil ,R.P.Patil, K.R.Jadhav	250
4	ME-04	Throwing Profile and Tools on the Potter's Wheel for The Production in the Pottery: A Critical Review	Nandkishor M. Sawai Dr. V. G. Arajpure Dr. C. C. Handa	257
5	ME-05	Investigation of MPFI System using Magnetism for Petrol Engine Enhancement	Nilesh T. Waykole Tushar A. Koli Dr.Vijay H. Patil	263
6	ME-06	Design and Analysis of Go-Kart Wheel Rim by Using CATIA and ANSYS	Yash Fule Sopan Kadu Akshay Amrutkar	269

			Hitesh Khirsagar Prof.Avinash Panchal	
7	ME-07	A Review on Hill Descend Control System for Vehicle	Salunke Rahul Prabhakar Chaudhari Homraj Ashok Patil Mahendra Shantaram Valvi Sharad Surupsing Chandankar Pradnya Milind Prof. M.P.Thakur	276
8	ME-08	Study on Optimization of Operating Performance of Bicycle, Tricycle and other Similar Vehicles	Pravin Dharmaraj Patil Mahesh Ashok Marathe Anand O. Dubey Abhishek P. Shukla	281
9	ME-09	Experimental Investigation of Human Operated Water Pumping With Electricity Generation	Pravin Dharmaraj Patil Mahesh Ashok Marathe Dipak V. Chaudhari Nikhil Bari	286
10	ME-10	Review on Design of Stationary Spindle Swaging Machine	Vaibhav Patil Amol Mundokar Yogendra Patil Swapnil Suryavanshi Samadhan Bhutekar K.M.Mahajan	291
11	ME-11	A Review on Design of Hydraulic Mold Splitter and Tipper Equipment	Mr. Abhyuday Joshi Mr. Girish Patil Mr. Lalit Rane Mr. Ravindra Patil Prof. Tushar Koli	294
12	ME-12	Comparative Analysis of Metallic & Non Metallic Spur Gear – A Review	Shailendra Sakharam Wani Dr. V. G. Arajpure	297
13	ME-13	Hybrid Multi-Pressure Distillation – Molecular Sieve Dehydration Technology: A Reliable Approach for Energy Optimization in Bioethanol Production Process	Dr. Nilesh P. Patil	303
14	ME-14	Design and Fabrication of Prototype Automatic Braking System and Pneumatic Bumper for Automotives	Prof.Y.J.Wagh Dr.V.G.Arajpure Prof.S.D.Galande	308
15	ME-15	A Review on Design and Fabrication of Brush Making Machine	Nilesh Vishvasrao Suryawanshi Rakesh Dhansing Pawara	316

			SK. Altamash SK Qadir Shubham Sanjay Pate Prashant Ashok Patil Prof. Vijay S. Chavan	
16	ME-16	Finite Element Analysis of Petrol Engine Crank Shaft- Review	Mr. Chandan. A. Patil Mr.V.P.Kolhe Bharat B.Waghode	321
17	ME-17	Implementation of Process Capability Study to Improve the Quality of the Piston Manufacturing Process in Batch Production	S. M. Wani A. R. Bang H. S. Rane A. D. Bagul Dr. V. G. Arajpure	330
18	ME-18	A Review of Solar water Distillation System with Different Basin Materials and Vacuum	Vishal A. Kale Denin Chalakkal Aniruddha Y. Chaudhari	335
19	ME-19	A Review Paper On Chairless Chair	Mr.Jagtap Vinayak Mr.Vyas Mahesh Mr. Mahajan Chetan3 Mr. Soni Vijay Mr. Bonde Pankaj Prof. Talha Ahmed	340
20	ME-20	A Review On Automatic Tyre Inflation System	Patil Tejas Sanjay Patil Dhanraj Gulabrao Nikum Mayur Chandrakant Pawar Rohit Shamkant Pingale Mayur Suresh Dr. V H Patil	344
21	ME-21	A Review On Manufacturing Of Cooling Tower	Mr. Aakash Shinde Mr. Danish Khan Mr. Pawan Deore Mr. Kunal Sonawane Mr. Rehan Shaikh Dr. V. H. Patil	347
22	ME-22	Design of Compact Condenser for Heat Recovery and COP Enhancement of Domestic Refrigerator	Miss. H.G.Nathjogi Mr. V. G. Nathjogi Prof. Tushar A. Koli Dr.V.H.Patil	351
23	ME-23	Energy Involvement in the Transportation of Building Materials	Kishor M. Mahajan Tushar A, Koli Dr. V. H. Patil	357
24	ME-24	CFD Simulations of 2D Venturimeter	Prof. Narkhede Laxmikant P. Mr. Limesh V. Mahajan Mr. Pratik S. Lad	361
25	ME-25	Experimental and Finite Element Analysis of Bending	Bhatu Borane Tushar A Koli	368

		Effect on Leaf Spring.		
26	ME-26	A Review on Advance Intelligent Parking Brake System	Shahnawaz Khan Khan Naved Behere Kamlesh Deepesh Chaudhari Pinjari Salman Prof.Mayur Thakur	373
27	ME-27	Double Axis Welding Machine Attachment	Umesh Patil Kishor M. Mahajan Dr. V.H.Patil	376
28	ME-28	Performance Improvement of Vortex Tube, By Varying Inside Surface Roughness of Cylindrical Hot Tubes	Nitin Vijay Galwade Prof. Tushar A Koli Dr. V H Patil	384
29	ME-29	Maximising the Heat Transfer Through Fins Using CFD as a Tool	Kumbhar Shanteshwar I. Koli Tushar A. Thakur.M.P.	391
30	ME-30	Experimental Set Up For Measurement of Strain by Using Strain Gauges on Simply Supported Beam and Analysis on ANSYS	Salve Mohanraj Tushar A. Koli Dr.V.H.Patil	399
31	ME-31	Design And Develoment Of Flywheel To Generate Eletricity	Pravin Dharmaraj Patil Viki Bhadane Patil Harshal Bhagwan Bhalerao Prashant gulabrao	403
32	ME-32	A Review on Design Development of Interchangeable Tool Head and Auto-Feed Table Mechanism for Portable Orbital Form Riveter	P.P.Gawande Tushar A Koli Dr.V. H.Patil	407
Electrical Engineering (EE)				
1	EE-01	Solar Powered Water Dispencer	Darshan Patil, Mayur Patil, Vishnu Shirsagar, Apurva Nemade, Gaurav kolte' MaheshPatil	410
2	EE-02	Automatic Power Factor Correction	Sachin Maheshri, SonuWarkhade, Sagar Chaudhari, Diptee Patil, Harshal Pawar	413
3	EE-03	Solar Based Grass Cutter Machine	Sachin Maheshri, Ritesh Patil , Hemant Avasrmal , Shubham Bhad	416

4	EE-04	GSM Based Three Phase Induction Motor Protection and Control	Shubham Chaudhari, Girish Mali, Mahesh Kasar, Amar Bagul, Atul Barahate	421
5	EE-05	Analysis Of Solar Small Size 100 Va Inverter For 55Watt Led TV	Mahesh H. Patil' Tushar S. Patil, Shubham S. Patil, Madhuri R. Patil,	424
6	EE-06	PLC Based Object Sorting According To Height	Vijay Choudhary, Sagar Kale, Shubham More, Mahesh Patil, Bharat Patil	428
7	EE-07	Brushless Dc Motor Speed Control Using Microcontroller	Vijay Chaudhary, Mohd AdilPinjari, Shaikh Nadeem, Rahul Badgujar, Rahul Lokhande	432
8	EE-08	Grid Synchronized Voltage Source Inverter Controlled By Using PI Controller	Sushil Kale, Pankaj Bari, Nikita Dhake, Dipak Patil, Atul Barhate, Amit Borole	435
9	EE-09	Solar Based Automatic Irrigation System	Bhagwat Shelke, Abhishek Joshi, Saurabh Patil, Yogita Waykole, Shruti Nimje	440
10	EE-10	Sustainable Trend and Necessity for Future Smarter Nation by Smart Grid	Bipasa Roy Patra	443
11	EE-11	Electrical Hoist	Dinesh Sangle, BhushanGunjal, PankajShelake, Rahul Rajput, Mahesh Patil ⁵	449
12	EE-12	Harmonic Elimination In Variable Frequency Drive By Shunt Hybrid Active Power Filter.	Yojana Bharambe, K.M.Mahajan	452
13	EE-13	VSC-Based HVDC Transmission System: An Overview	HarishPatil, K.M. Mahajan	456
14	EE-14	Design of Three Phase Induction Motor with Pole	Hitesh Patil' Manoj Thelari, Devendra	461

		Change Array	Chaudhari, Bhushan Patil, Atul Barhate	
15	EE-15	Remote Monitoring of Distribution Transformer Using GSM Module	Shalaka A. Chavan, Mitali A. Gaikwad, Tejas V. Ganyarpawar, Apurva A. Shinge, Shubham D. Shirgaonkar, Umesh Barhate	467
16	EE-16	EE-16_Induction Motor Protection System	Priyanka Koli, Shiva Pokhrel, Yojana Bharambe	472
Applied Science (ASc)				
1	ASc-01	An Eco-Friendly Protocol For Synthesis Of Dihydropyrimidone Catalysed By Disodium Hydrogen Phosphate.	Harshal Prabhakar Patil, Harshal Tukaram Borole, Nilesh Ishwar Patil, Suryakant Patil	475
2	ASC-02	Nano sized ZnO: Synthesis, Characterisation And Gas Sensing	Saroj D. Patil, Nitin N. Bhole, R. B. Waghulade	478
3	ASC-03	Techniques of pollution control in construction	Patil Lalita B.	482

Investigation of Microstrip Circular Patch Antenna and Step Discontinuities in Feed Line

Dr. Tarun kumar Kanade ¹, Prof. Maheshkumar A. Pardesi ², Vijay D. Chaudhari ³

Dr. Anil J. Patil ⁴, Dr. S. B. Deosarkar ⁵

¹ Design Engineer, RFMtronics, Bhopal, Madhya Pradesh, India

² Associate Professor, Electronics Engineering Dept., D Y Patil College of Engineering and Technology, Kolhapur

³ Ph.D. Scholar, Electronics Engg. N. M. University and Faculty- GF's Godavari College of Engg Jalgaon, (M.S.) India.

⁴ Principal, Shri. Gulabrao College of Engg. & Ex. BOS-Electronics Engg, North Maharashtra University, Jalgaon, (M.S.)

⁵ Professor, E&TC Engg. Dept, Dr. Babasaheb Ambedkar Technological University, Lonere-Raigad, (M.S.) India

¹ Sai_tk@rediffmail.com, ² map6623@gmail.com, ³ vinuda_chaudhari@yahoo.co.in

Abstract – This paper presents the study and investigation of microstrip circular patch antenna and its feed line. Planar antennas such as microstrip and its modifies versions have an attractive features of low profile, miniature size and conformability to mounting hosts and are flexible component for designing purpose. Due to its versatility researchers from RF and Microwave field have attracted towards the compact and broad band design techniques for planar antennas. Microstrip patch antenna has found its wide range of applications in communication devices for wireless local area network (WLAN) systems in 2.45 GHz (2400-2484 MHz). The performance of microstrip patch antenna mainly depends on its return loss S_{11} (dB), Gain, NearETotal field and E & H field. The performances of microstrip patch antenna were considerable modified by introducing some discontinuities in a feed line. In this paper a microstrip circular patch antenna with single and double step discontinuities were investigated and the performance of circular patch antennas were found to be increased by using double step discontinuities.

Keywords- Circular microstrip patch antenna, step discontinuities, feed line, return loss, Gain and E & H field

INTRODUCTION

Microstrip patch antenna are flat in appearance and have a low profile, recently received much attention for application in cellular communication systems, such as global system for mobile communication (GSM), the digital communication system (DCS), satellite communication, wireless local area networks and many

more. Novel designs of planar antenna for applications such as internal mobile phone antennas, base station antennas, WLAN or Bluetooth antennas, required for achieving broadband circular polarization (CP) and dual-polarized radiation to enhance system performance. Planar antennas are also extremely smart for purpose in communication devices for wireless local area network (WLAN) systems in the 2.4 GHz (2400-2484 MHz) and 5.2 GHz (5150 – 5350 MHz). The most commonly used planar antenna is rectangular microstrip patch antennas, in which the characteristics of the antenna depends on the length and breadth of the metallic patch and substrate. The substrate should have low dielectric constant for higher radiation efficiency and thickness to increases the impedance bandwidth [1]-[3].

In addition to the rectangular patch, the subsequently most popular configuration is the circular patch or disk. The modes that are supported principally by a circular microstrip antenna whose substrate height is small ($h \ll \lambda$) are TM^z , where z is taken perpendicular to the patch. In a rectangular microstrip patch antenna, the order of the modes can be changed by changing the relative dimensions of the width and length of patch (width-to-length ratio). On the other hand, for the circular patch there is only one degree of freedom to control i.e. radius of the patch, which does not modify the order of modes but transform the absolute value of resonant frequency. The commonly used analytical methods to study circular patch antennas were full-wave analysis and cavity model. In a cavity model there are two perfect electric conductors at the top and bottom to represent patch and ground surrounded by perfect magnetic conductor [4]-[7]. In a low profile single and

double array microstrip, FR4 substrate is used to design antenna. The simulation and analysis done at 2.45 GHz to compare single and double array rectangular & circular microstrip patch to get a minimum return loss, optimum radiation pattern, gain and directivity and proved that single array patch antenna does not shows optimum performance over double array patch antenna. [13].

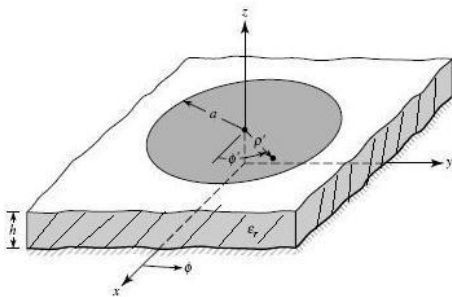

Fig. 1- cross sectional view of circular patch antenna

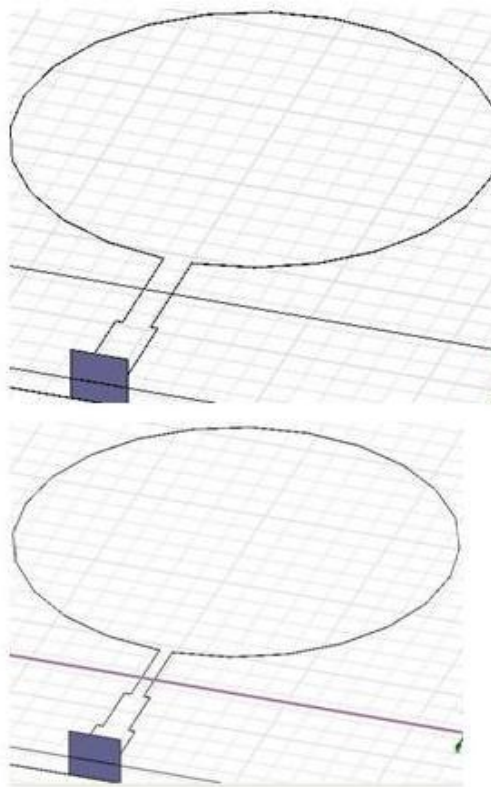

Fig. 2- two-D view of circular microstrip patch antenna single step and double feed line

DESIGN CONSIDERATION

Based on the cavity model, practical design of circular microstrip antennas for the dominant TM^z modes requires the information that includes dielectric constant of the substrate (ϵ_r), the resonant frequency (f_r) and the height of the substrate (h). The empirical formula for the radius of the patch is given by many researchers, the commonly used is [3]-[7]

$$a = \frac{F}{\sqrt{\left\{1 + \frac{2h}{\pi\epsilon_r F} \left[\ln\left(\frac{\pi F}{2h}\right) + 1.7726 \right] \right\}}}$$

Where $F = \frac{8.791 \times 10^9}{f_r \sqrt{\epsilon_r}}$

ANALYSIS OF CIRCULAR PATCH ANTENNA

The circular microstrip patch antenna and its feed line are designed, simulated and investigated with software based on FEM. The circular microstrip patch antennas are designed on FR4 substrate. The output parameters like return loss S_{11} (dB), Gain, NearETotal field and E & H field were studied and investigated. The circular patch antenna with double step feed line shows better results as compared to single step feed line. At 2.45 GHz the return loss S_{11} (dB), for double step feed line is -16.775 dB and for single step feed line it is -10.45 dB. The return loss for FR4 substrate with $\epsilon_r = 4.4$ are shown in Fig. 3 and Fig. 4.

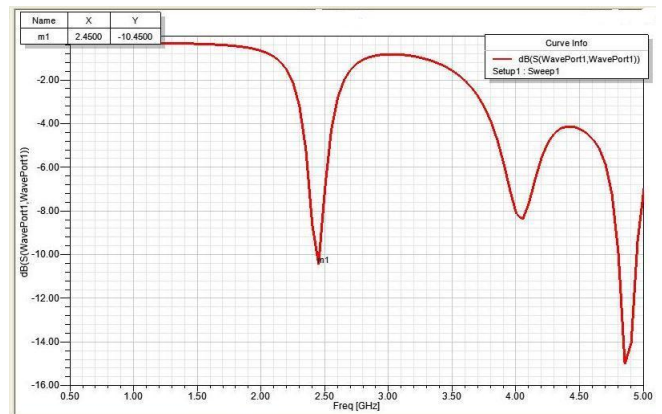

Fig. 3- return loss S_{11} (dB) versus frequency on FR4 for single step feed line circular patch antenna

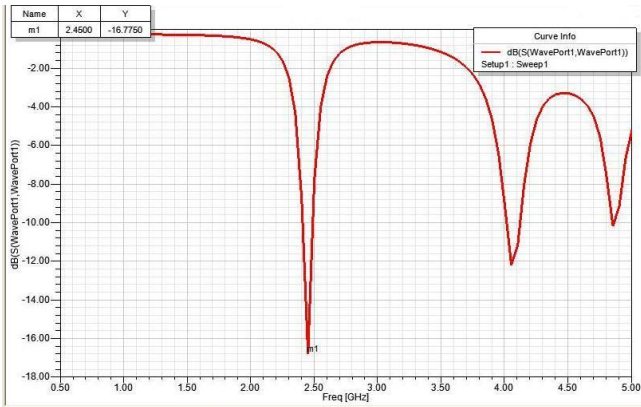

Fig. 4- return loss S_{11} (dB) versus frequency on FR4 for double step feed line circular parch antenna

The gain for double step feed line is $1.075e+000$, where as for single step feed line it is $1.011e+000$. The simulated results obtained by double step feed line microstrip circular patch antenna is appropriate as compared to single step feed line. It shows that the step discontinuity modifies the capabilities of microstrip patch antenna. Fig 5 and Fig. 6 shows the gain and E-field for single step feed line circular patch antenna. Fig 7 and Fig. 7 shows the gain and E-field for double step feed line circular patch antenna.

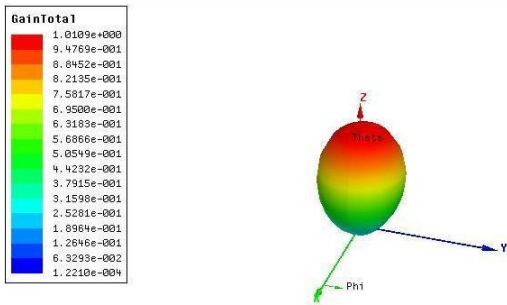

Fig. 5- gain total on FR4 for single step feed line circular patch antenna

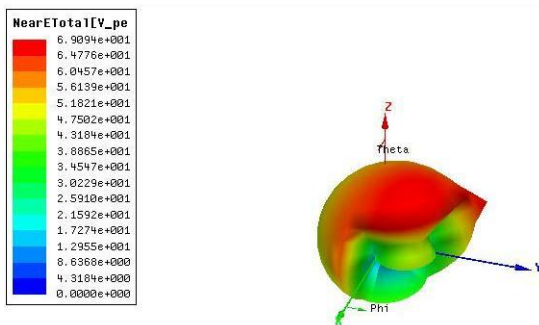

Fig. 6- near E-total on FR4 for single step feed line circular patch antenna

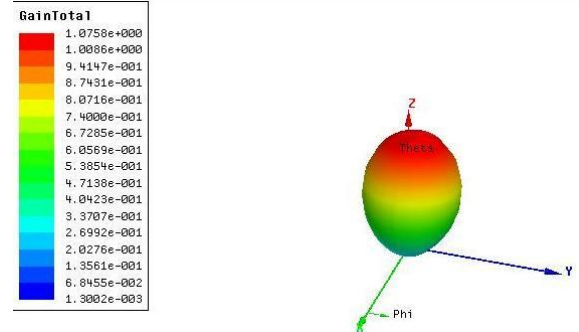

Fig. 7- gain total on FR4 for double step feed line circular patch antenna

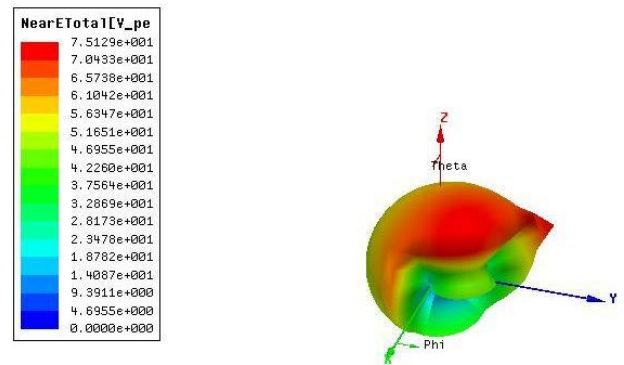

Fig. 8- near E-total on FR4 for double step feed line circular patch antenna

The H-field (A/m) for circular microstrip patch antennas with single and double step microstrip feed lines is shown in fig. 9 and fig. 10.

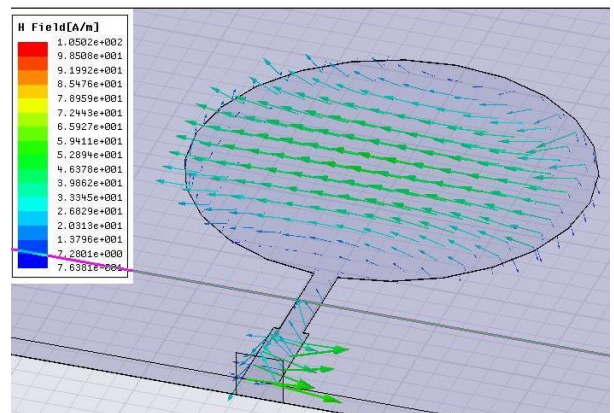

Fig. 8- H-field on FR4 for single step feed line circular patch antenna

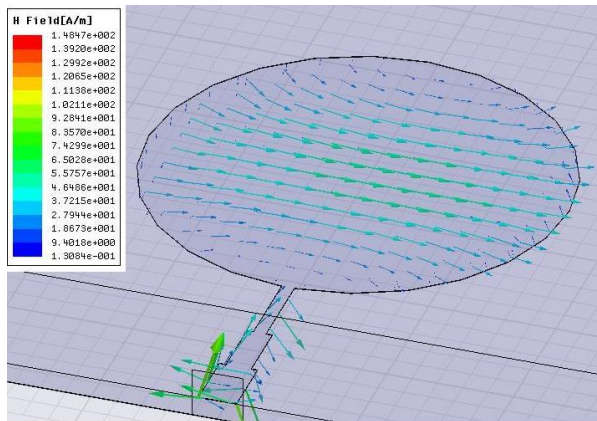

Fig. 9- H-field on FR4 for double step feed line circular patch antenna

CONCLUSION

A low profile circular microstrip patch antenna with single and double step feed lines are designed, analyzed and studied here at 2.45 GHz. The substrate used for designing antennas is FR4. The novel purpose of creating an antenna with single and double step discontinuities in feed lines at 2.45 GHz is to get a minimum return loss, optimum radiation pattern, gain and directivity. The microstrip discontinuities particularly step discontinuities i.e. single or double step create an antenna performance enhanced than a patch antenna with a straight feed line. The simulation results shown that a circular microstrip patch antenna with double step feed line have better results as compared with a single step feed line.

REFERENCES

- [1] T. A. Milligan, "Modern Antenna Design", Mc Graw-Hill Book Co., New York, 1985.
- [2] J. R. James, P. S. Hall and C. Wood, "Microstrip Antenna Theory and Design", Peter Peregrinus, London, UK, 1981.
- [3] Balanis, C. A., "Antenna Theory: analysis and Design", John Wiley & sons, New York, 1997.
- [4] Wong, Kin-Lu, "Compact and Broadband Microstrip Antennas", John Wiley & sons, New York, 2002.
- [5] Garg, R., Bhartia, P., Bhal, I., and Ittipiboon, A., "Microstrip Antenna Design Handbook", Artech House Inc. Boston, 2001.
- [6] Pozar, D. M., "Microstrip Antennas", IEEE proceedings, vol. 80, 79-91, January 1992.
- [7] Kumar, G. and K. P. Ray, "Broadband Microstrip Antennas", Artech House, 1981, 2003.
- [8] Hoffman, R. K., "Handbook of Microwave Integrated Circuits", Norwood, MA: Artech House, 1987.

- [9] Gupta K. C., Ramesh Garg, Inder Bahl and Prakash Bhartia, "Microstrip Lines and Slot Lines", Artech House Inc. Washington, 1996.
- [10] Bharathi Bhat and Shibani K. Koul, "Stripline-like Transmission Lines for Microwave Integrated Circuits", Wiley Eastern Limited New-Delhi, 1980.
- [11] Edwards, Terry, "Foundations for Microstrip Circuit Design", 2nd ed., Chichester, U.K: John Wiley & Sons, 1992.
- [12] Keith R. Carver and James W. Mink, "Microstrip Antenna Technology," IEEE Trans. Antenna Propagat., vol. AP-29, no.1, pp. 2-22, Jan. 1981.
- [13] Dr. Tarun Kumar Kanade, Vijay D. Chaudhari, Dr. A. J. Patil, Dr. S. B. Deosarkar " Investigation of Single and Double Array Patch Antenna", Proceedings of NACCTESTM-2017, 21 March, 2017; INTERNATIONAL JOURNAL OF ADVANCED ELECTRONICS & COMMUNICATION SYSTEMS Approved by CSIR-NISCAIR ISSN NO: 2277-7318 , pp. 88-91.

National Conference on Current Trends in Engineering, Science and Technology (NACCTEST- 2018)
 Organized by GF's Godavari College of Engineering, Jalgaon
International Journal of Innovations in Engineering and Science, Special Conference Issue, 2018
 www.ijies.net

Intelligent Medicine Tray for ICUs in Hospitals: A Literature Review

Prajakta M. Borse¹, Ishwar S. Jadhav², Vijay D. Chaudhari³ H. T. Ingale⁴

¹ PG Student, GF's Godavari College of Engineering, Jalgaon, India, 425001
^{2,3,4} Assistant Professor, Godavari College of Engineering, Jalgaon, India, 425001
¹prajaktaborse14@gmail.com

Abstract – We reside in a fast growing nation where one can progress only when one gets his basic needs fulfilled. But these basic needs will be enrooted properly only when public health is proper. Due to the rapid development, people keep working hard without caring for their own health. Main reason behind this is the lack of time and also health is considered to be a secondary factor when earning is compared. We earn enough to survive. But again they need to worry about securing their earnings. Thus we need to focus on health and security. Health Monitoring and Home Automation systems mainly focus on medical and home security fields. The new era can be facilitated with Health Monitoring and Home Automation systems using Wireless Technologies as Wired being more complex and bulkier. Due to rapid rate of growth in human development, people forget to look after their health leading to unhealthy lifestyle which further takes turn to various sudden health issues which need to be treated as soon as detected. If these issues are not resolved, it will deteriorate human health. This topic is itself a novel approach to monitor patient health and provide proper timely treatment using an intelligent medicine tray.

Keywords- *Medicine Trolley, Arduino, Sensors, Health Monitoring, IoT*

INTRODUCTION

This survey paper proposes architecture for an Intelligent Trolley System (ITS) that can be used by hospital care staff, nurses and physicians to identify the patients who need an immediate or urgent attention. The

system mainly focuses on hospital bound patients who have limited mobility and reduced ability to call for help when needed. The system will be helpful in chronic

medical conditions such as doctor away from ICU, Chronic Obstructive Pulmonary Disease (COPD) and Heart Disease.

The smart sensors can monitor patient information like heart rate (HR), Body temperature, and level of saline bottle. Moreover, in recent cases the symptoms diary is maintained through a personal digital assistant (PDA) but in our project we read all these parameters using sensor and show on remote desktop PC using IoT (internet of things). The data from the sensor network and PDA are automatically uploaded to a remote server using Wi-Fi. The server shows the patients information and extracts the non-trivial information from the patients' histories, symptoms diaries and management strategies. This system uniquely generates alert signals to provide timely treatment to patients' chronic medical conditions. A survey has been done by studying various methodologies used by researchers and a comparative study has been done to determine the best suitable technique. In short, this survey focuses on four main objects:

1. Intelligent Medicine Trolley
2. Sensors to keep monitoring parameters like body temperature, Heart rate and the level of saline bottle with respect to each patient.
3. Alert Panel with buzzer and indication.
4. IoT for remote access.

Thus this system may prove very time efficient and error free. Also group of nurses need not to be always present in the ICUs and only one person may be enough in ICU to look after patients. This will help in avoiding the chaos in ICUs that take place due nurses and relatives present in ICUs. Currently we are trying to implement only four patient beds in ICU with four patients. This number of beds and patients is not limited to four and

National Conference on Current Trends in Engineering, Science and Technology (NACCTEST- 2018)
Organized by GF's Godavari College of Engineering, Jalgaon
International Journal of Innovations in Engineering and Science, Special Conference Issue, 2018
www.ijies.net

thus can be increased in future with successful implementation of this system under progress.

OBJECTIVE OF THIS SURVEY

Patient's family members are always worried even more when the patient is in ICU and they can't see or meet him. They keep waiting outside the ICU making chaos there but that's so true to some extent because many times the patients are lying on beds in ICU and there is no one to look after them neither to give them medicines nor to replace an empty saline bottle. It may happen that the doctor or in-charge nurse may be busy in treating some other emergency case but then who will look after these patients already in ICUs is the main question. This system promises the objective by making use of bio sensors, Arduino microcontroller and IoT. Arduino being easier to understand and IoT compatible can easily adjust itself to background requirement based on the programming. IoT is the boom is today's market and helps the devices in our system to communicate over internet. Making use of remote IoT will help the doctor at any other location to know his patient's health status within no time.

EXISTING SYSTEMS

You must have seen that due to increasing health disorders, hospitals are never seen vacant. To treat number of disorders at one place Multispecialty hospitals are developed. Health issues like heart strokes, diabetes, accidents and many more fill the ICUs with no vacant bed. An empty bed is filled upon immediately by a new case. In such scenario the Doctors can't be present everywhere and thus have to assign in-charge person to take care of the patients. Due to large number of patients there are chances of occurrence of medication errors which may harm the patient health. Moreover there should be accurate and timely treatment because one has no right to play with patient's health. To overcome all such problems, an Intelligent Medicine tray assembly is designed using IoT. To know a patient's health status, a doctor need to be always present with him and can know it remotely through portable devices like Android Mobiles, Laptops, PCs. During our survey, we have even come across a system where the patient is conveyed through a message about when he has to take his medicine and also the dosage of the medicine is conveyed with time [13]. This concept would also be

very useful in future development of our work in case when the patient is discharged from the hospital. This will help the patient to take his medicine timely even when he will be home. This will also reduce the regular supervision on patient by his relatives or the nurses.

METHODOLOGY

After studying the various aspects about the methods, technologies used in earlier systems, we have tried here to propose few modifications that can make the medicine trolley more effective. With the rapid development of upcoming technologies, Arduino and IoT have emerged as a boon, thus accelerating the rate of development. Due to the enormous growth in upcoming technologies, humans are getting adapted to them in various ways. Wireless communication has brought a revolutionary change in field of communication. These wireless technologies aim to exchange data wirelessly providing a wide range of applications. Depending on the communication range, controllability, application and many other factors, the suitable one is selected. Patients in Hospitals need timely check up and very time efficient treatment. This survey helps us in developing a very time efficient system for treating patients in multispecialty hospitals. Generic health monitoring system [2] talks about the rapid growing heart issues and how to tackle them remotely without the regular visits of doctors. It makes use of emerging wireless technologies. It enhances the idea by using IoT that's internet of things. Arduino would be a perfect integration along with IoT as brain for this system.

MEDICINE TROLLEY CONCEPT

In hospital, doctor has to give regular doses of medicine to patients at particular time interval and each dose has different medicine time. Presently nurses take this medicine from store room and move it to patient's bed. But here we use Real Time Clock (RTC) which read time and date and when patient medicine doses time occurs, this trolley automatically carry this medicine to patient bed. On this tray, all medicine doses will already be placed by doctor according to patient condition. This is the purpose of robotic trolley which is nothing but a line following robot. It has been showed in [6] that IoT has huge potential in terms of home and health care services. It uses a system based on IoT for health care but to be précised, they are using home based health care service. It involves intelligent medicine box (iMedBox) with

National Conference on Current Trends in Engineering, Science and Technology (NACCTEST- 2018)
 Organized by GF's Godavari College of Engineering, Jalgaon
International Journal of Innovations in Engineering and Science, Special Conference Issue, 2018
 www.ijies.net

good connectivity and interchanging capability. It also uses intelligent pharmaceutical packaging (iMedPack) enabled with RFID. Next is flexible and wearable bio sensor i.e. bio patch enabled by inkjet printing technology and SoC.



Fig.1. Medicine Trolley (usually we see)

Survey carried out in developing this system mainly focuses on achieving following objectives:

1. Intelligent Medicine Trolley
2. Monitoring patient's health using sensors like heart rate sensor, body temperature sensor and saline level indicator.
3. Alert Panel for giving alert signal in case of emergency
4. IoT for remote access

With the aim of achieving the foresaid goals, we have worked on various systems used by researchers and we have thus evaluated following block diagram. Intelligent health monitoring [1] controlled embedded systems by taking care of patients form aspects like monitoring bio parameters, medications, important signs related to health. It involves a wide platform for intelligent medicine box with good connectivity and information interchange ability for devices and services integration. It proposes in home healthcare service for improved results and superior efficiency. Digital sensing of bio parameters like body temperature and heart rate [5] is discussed with respect to Raspberry Pi, here they make use of Arduino for health monitoring. Arduino is used as it can sense the environmental changes using the sensors as inputs. Arduino is programmed using the Arduino programming language. It has used LM35 as body temperature sensor. Heart beat sensor used here measures the MAP mean arterial pressure.

COMPARATIVE STUDY ON USE OF ARDUINO OVER RASPBERRY PI

Arduino being easily available is obviously cheaper than Raspberry Pi. Arduino is very useful when it comes to a small scale project. Important features with reference to Arduino are its inexpensive, it's cross platform. Also Arduino is a handy board and its compilers required for programming are easily available. Also being Electronics platform, programming in C language in case of Arduino is easier than Java programming in case of Raspberry Pi. Arduino is an open source with extensible hardware and extensible software.

PURPOSE OF USING IOT TECHNOLOGY IN OUR WORK

Here we are using this technology for remote location of biomedical parameter such as heartbeat, body temperature, and saline level. In IoT projects, all the physical objects (things) are connected together using internet infrastructure. "Internet of Things" IoT has increasingly become a topic of conversation with respect to the emerging technologies. Broadband Internet is easily available and the cost of connecting it is decreasing, more devices are being created with Wi-Fi capabilities and sensors built into them, technology costs are going down, and Smartphone penetration is skyrocketing. All of these things are creating a "perfect boom" for the IoT. This is the concept of using IoT here which will basically connect any device with an on and off switch to the Internet (and/or to each other).

IoT is the topic of conversation [3] almost in all fields of technology. It proposes an IoT based system to monitor patient's health parameters like blood pressure, heartbeat, and pulse rate. This health observation system will keep track of above mentioned bio parameters. If any of the parameters being monitored goes beyond the predefined range, then the status will be send to the concerned person over IoT and will shown live over internet.

OUR PRAPOSED SYSTEM

Proposed system works on the basis of below shown block diagram.

National Conference on Current Trends in Engineering, Science and Technology (NACCCTEST- 2018)
Organized by GF's Godavari College of Engineering, Jalgaon
International Journal of Innovations in Engineering and Science, Special Conference Issue, 2018
www.ijies.net

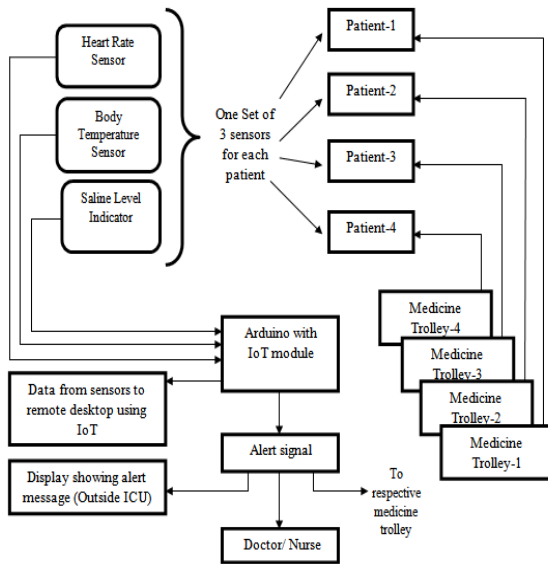

Fig.2. System Block Diagram

Algorithmic steps involved in working of this system:

1. The proposed system will continuously monitor the three sensors.
2. If any parameter viz. Heart rate, body temperature or saline level mismatches with the standard mentioned value, alert signal will sound.
3. Same time, alert message will be shown on the display outside ICU unit.
4. Arduino controller will alert the incharge Doctor/ Nurse.
5. By the time, Doctor/ Nurse arrives the patient, trolley will be ready with the required medicines beside the patient.
6. Doctor/ Nurse will come and check the patient and provide required treatment.
7. If patient is left unattended or untreated then again an alert signal will sound and shown on display outside ICU.
8. If the Doctor is out of station and needs to check the patient health status, he can check it using IoT.

CONCLUSION

This system thus proposed aims at treating patient without time lag and very efficiently. This can be done by making use of bio sensors, Arduino microcontroller

IoT. Arduino being easier to understand and IoT compatible can easily adjust itself to background requirement based on the programming. It will be implemented for four patient beds in ICU with four medicine trolley. There is no limitation on number of patients and trolleys or the number of bio parameters to be monitored but can be developed in future for large scale application.

REFERENCES

- [1] P. Raga Lavima, Mr. G. Subhramanya Sarma (October 2015). "An IoT Based Intelligent Medicine Box" *IJCSMC* | Vol. 4, Issue. 10, October 2015, pg.186 – 191| ISSN: 2320-088X
- [2] Vivek Pardeshi, Saurabh Sagar, Swapnil Murmurwar, Pankaj Hage (2017). "Health Monitoring Systems using IoT and Raspberry Pi – A Review" *ICIMIA* | 978-1-5090-5960-7/17/\$31.00 ©2017 IEEE.
- [3] Himadri Nath Saha, Supratim Auddy, Subrata Pal, Shubham Kumar, Shivesh Pandey, Rocky Singh, Amrendra Kumar Singh, Priyanshu Sharan, Debmalya Ghosh, Sanhita Saha (2017). "Health Monitoring Systems using IoT" , 978-1-5386-2215-5/17/\$31.00 ©2017 IEEE.
- [4] Sarfraz Fayaz Khan (2017). "Health Care Monitoring System in Internet of Things (IoT) by Using RFID" *ITM* | 978-1-5090-5330-8/17/\$31.00 ©2017 IEEE.
- [5] Salomi S. Thomas, Mr. Amar Saraswat, Anurag Shashwat, Dr. Vishal Bharti (2016). "Sensing Heart beat and Body Temperature digitally using Arduino" *SCOPE* | 978-1-5090-4620-1/16/\$31.00 ©2016 IEEE.
- [6] Geng Yang, Li Xie, Matti Mäntyselä, Xiaolin Zhou, Zhibo Pang, Li Da Xu, Sharon Kao-Walter, Qiang Chen, Lirong Zheng (2014). "A Health-IoT Platform Based on the Integration of Intelligent Packaging, Unobtrusive Bio-Sensor and Intelligent Medicine Box" DOI 10.1109/TII.2014.2307795, *IEEE*.
- [7] R. Kumar, Dr.M.Pallikonda Rajasekaran (2016). "An IoT Based Patient Monitoring System Using Raspberry Pi", *ICCTIDE* | DOI: 10.1109/ICCTIDE.2016.7725378
- [8] Kunja Bihari Swain, Satyasopan Mahato, Meerina Patro, Sudeepta Kumar Pattanayak (2017). "Cattle health monitoring system using Arduino and LabVIEW for early detection of diseases", *ICSSS* | 978-1-5090-4929-5 ©2017 IEEE.
- [9] Sowmya G, Sandeep B L (April 2016). "Remote HealthCare Monitoring System Using Arduino Board over Distributed Ubiquitous Environment", *IJARCC* | Vol. 5, Issue 4, and April 2016 | ISSN: 2278-1021.
- [10] Akshay Sugathan, Gaurav Gautam Roy, G.J Kirthyvijay, Jeffrey Thomson (2013). "Application of Arduino Based Platform for Wearable Health Monitoring System", *CATCON 2013* | 978-1-4799-0083-1/13/\$31.00 ©2013 IEEE.
- [11] Tao Zhang, Zhaohua Liu, Xuejiao CAO, Weixi Xia (2015). "Intelligent Medicine Box Monitoring and Management System", *International Conference on Computer Science and Mechanical Automation 2015* | DOI 10.1109/CSMA.2015.37
- [12] Pierre E Hertzog, Arthur J Swart (April 2016). "Arduino – Enabling engineering students to obtain academic success in a design-based module", *EDUCON* | 10-13 April 2016, Abu Dhabi, UAE.
- [13] Nitesh P Sonawane, Vijay D Chaudhari, Ganesh Thakur (November 2016). "Comprehensive Survey on Automatic Reminder Systems", *IJRITCC* | November 2016 | ISSN: 2321-813

National Conference on Current Trends in Engineering, Science and Technology (NACCTEST- 2018)
Organized by GF's Godavari College of Engineering, Jalgaon
International Journal of Innovations in Engineering and Science, Special Conference Issue, 2018
www.ijies.net

Survey on Printed Antenna for Wireless Communication

Aditi A. Patil¹, Dipali N. Bharambe², Chetashri A. Jawale³, R. V. Patil⁴ Mahesh N. Patil⁵

^{1,2,3} Students, Department of Electronics and Telecommunication
GF's Godavari College of Engineering, Jalgaon, India
^{4,5} Associate prof in department of Electronics and Telecommunication
GF's Godavari College of Engineering, Jalgaon, India
⁵ mahesh_npatil@rediffmail.com

Abstract – Now a day there are vast development in wireless communication technology so size of antenna is reduced by day by day. In past year mostly yagi uda antenna was used. But convectional antenna has less advantages and prospects as compared to printed antenna. In this paper we are making survey to design proposed antenna for the frequency bandwidth 207MHz to 211MHz.

Keywords- Printed antenna (microstrip patch antenna), Microstrip Feed line

INTRODUCTION

The communication is the process of transferring the information from one point to another. The information which is to be transferred over a distance is commonly achieved by superimposing or modulating the information on to a electromagnetic wave which is act as carrier signal. At the destination this signal is received and original signal is extracted from this signal by using demodulation process. For the communication, antennas are most important components which are used to creat the communication link. Antenna is the transducer designed to transmit or receive electromagnetic waves. Printed antennas are the most common option for communication. Printed antenna have several advantages over the convectional microwave antennas. Printed antenna fabricated using microstrip technique on a printed circuit board. It is mostly used at microwave frequency. We can design printed antenna in various shapes like circular, rectangular, elliptical, dipole etc. in this paper we have design rectangular printed antenna. Some printed antenna do not use a dielectric substrate and instead are made of a metal patch mounted above a

ground lane using dielectric spacer. Printed antenna in its simplest configuration is as shown in fig 1

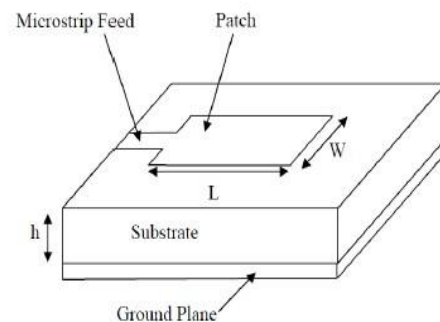

Fig 1. Printed antenna

LITERATURE SURVEY

1. Survey and review on gain enhancement methods of microstrip patch antenna:- Published by Anilkumar patil , Dr. B. Surykant

We know that microstrip patch antenna is widely used because of its low profile but simultaneously it is having some disadvantages such as lower bandwidth and lower gain. In this paper there are different technique used for enhancing bandwidth and gain of microstripn patch antenna[1]

2. Designing of S shaped microstrip patch antenna for broadband application using slotting technique:- Published by Menaka R., Nishandhi S., Sivaranjani S

In this paper they made a microstrip patch antenna of 4.5GHz frequency with 4.485% BW which is 1.595% more as compared his reference antenna[2]

National Conference on Current Trends in Engineering, Science and Technology (NACCTEST- 2018)
Organized by GF's Godavari College of Engineering, Jalgaon
International Journal of Innovations in Engineering and Science, Special Conference Issue, 2018
www.ijies.net

3.Performance analysis of rectangular microstrip patch antenna using different substrate material for WLAN application:- Published by E. Aravindraj, K. Ayyappan, R. Kumar.

In this paper a rectangular microstrip patch antenna is designed using different substrate such as alumina, bakelite, gallium, arsenide, RT-Duroid, FR-4 and beryllium oxide for the same frequency of 5.8GHz. this paper concludes that the rectangular microstrip patch antenna designed made of RT-Duroid substrate provide 23% improved result compared to other substrates. Therefore a good microstrip patch antenna is designed made of substrate with lower dielectric constant brings potential benefits in terms of less reflection coefficient, wider bandwidth and good impedance matching.[3]

4.Survey on bandwidth enhancement of microstrip patch antenna using H shaped patch:- Published by Chaitali Ingale, Anand Pathrikar

This paper represents the enhancement of bandwidth for microstrip antenna along with its structure. The antennas are very essential device for communication and it is used as a transmitter device and receiving device. for the microwave frequency communication the micro strip patch antenna is the best choice but it suffers for the problem of narrow bandwidth hence its necessary to overcome this advantages[4]

5.Rectengular patch antenna for infinite and finite ground plane:- Published by Maheshkumar Ninu Patil, Bhagwan Swaroop Sharma

In this paper antenna has been designed and simulated an infinite and finite ground plane for resonant frequency of 5GHz. Resonant frequency slightly change, return loss increase, VSWR increases and gain also increases[5]

6.Compact miniaturized antenna for 210MHz RFID:- Published by Richard Q. Lee, Kue Chun

This paper described the design and simulation miniaturized square ring antenna. The miniaturized antenna, with overall dimension of approximately one tenth of wavelength (0.1λ), was designed to operate at around 210MHz and was intended for radio frequency identification(RFID) application. One unique feature of

the design is the use of parasitic element to improve the performance and impedance matching of the antenna[6]

7.Design of a wideband reduced size microstrip antenna in VHF/lower UHF range:- Published by Manish Kumar, Manish Kumar Sinha, L.K. Bandyopadhyay, Sudhir Kumar

This paper presents wideband helical microstrip antenna with particular attention to high bandwidth, size reduction and low back lobe radiation in VHF/lower UHF band. The antenna inserted with shorting post, is double probe-fed having a minimum VSWR (voltage standing wave ratio) of 1.025 at the resonating frequency of 321.25MHz and 2:1 VSWR bandwidth of 183.5MHz. the antenna structure is finally arrived at after studying various dimensional effects on bandwidth and frequency of operation [7]

8.A Broadband VHF/UHF Double-Whip Antenna:- Published by Xiao Ding, Bing-Zhong Wang, Guang Ding Ge.

This paper presents a broadband VHF/UHF double-whip antenna with one lossless matching scheme combining two methods, embedded transmission line matching method and lumped-distributed hybrid matching method. By adjusting the length of the embedded transmission line, the combination of double-whip antenna and the transmission line can achieve resonance, thus realize a coarse matching. By adding a lumped-distributed hybrid matching network at the feeding point of the double-whip antenna, we can further improve the matching for the double-whip antenna. Moreover, based on the two-step matching scheme, a double-whip antenna has been designed and fabricated. Measured results show that, the VSWRs of the double-whip antenna, with the electrical lengths of 0.16λ and 0.03λ at the minimum operation frequency respectively, are less than 2 over a 17:1 octave bandwidth, and the horizontal gains of the antenna are between 4.2 dB and 6.8 dB. Double-whip antenna in this paper is ideal for application in vehicle wireless communication[8]

METHODOLOGY

We have proposed the antenna having frequency band 207MHz to 211MHz bandwidth. Such antenna can be used for the VHF band for doordarshan.

There are various feeding method for printed antenna.

Two categories of this method are:-

1. Contacting
2. Non-contacting

National Conference on Current Trends in Engineering, Science and Technology (NACCTEST- 2018)
Organized by GF's Godavari College of Engineering, Jalgaon
International Journal of Innovations in Engineering and Science, Special Conference Issue, 2018
www.ijies.net

In a non-contacting method electromagnetic field coupling is done to transfer power between microstrip line and radiating patch.

Four most popular technique are:-

1. Microstrip line
2. Coaxial line
3. Aperture coupling
4. Proximity coupling

from this technique we used microstrip line feeding technique

MICROSTRIP LINE FEED:

Microstrip line feed one of the easier method to fabricate as it is a just conducting strip connecting to the patch therefore. Consider as a extension of a patch i.e. microstrip line is conducting strip. The main advantages of this feed technique are that it eliminates spurious feed radiation and provides very high bandwidth of about 13% due to increase in the electrical thickness of the microstrip patch antenna. This kind of feed arrangement has the advantages that the feed can be etched on the same substrate to provide a planner structure.

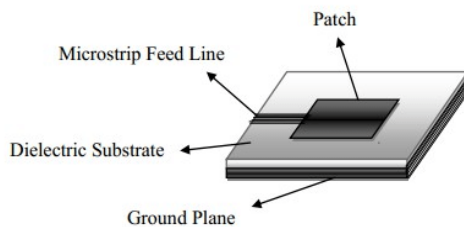

Fig 2. Microstrip feed line

It is easy to fabricate, simple to match by controlling the inset position. The purpose of inset cut in the patch is to match the impedance of the fed line to the patch[9]

SELECTION OF SOFTWARE

FEKO, IE3D, HFSS, CST these software are available for antenna design. Out of these IE3D is suitable option for design the antenna.

CONCLUSION

Within survey of an antenna we are going to proposed a printed antenna for VHF, which can be work on within the frequency bandwidth of 207-211MHz. It may be useful for Doordarshan like applications. For design of such antenna we have to consider the following points

1. Substrates
2. Width of antenna
3. Height of antenna
4. Feeding technique
5. Response

REFERENCE

1. Anilkumar Patil, Dr. B. Surykant, "A survey and review on gain enhancement methods on microstrip patch antenna", International Journal on Emerging Technologies, 2015
2. Menaka R., Nishandhi S., Shivarajani S., "Designing of S shaped microstrip patch antenna for broadband application using slotting technique", International Journal of Science and Research, 2015
3. E. Aravindraj, K. Ayyappan, R. Kumar., "Performance analysis of rectangular microstrip patch antenna using different substrate material for WLAN application", ICTACT Journal on communication Technology, March 2017, vol:08, issue:01
4. Chaitali Ingale, Anand Pathrikar., "Survey on bandwidth enhancement of microstrip patch antenna using H shaped patch", International Journal of Advanced Research in Computer and Communication Engineering, vil:02, issue:10, Oct 2013
5. Maheshkumar Ninu Patil, Bhagwan Swaroop Sharma, "Rectangular patch antenna for infinite and finite ground plane", International Journal of Advanced Technology in Engineering and Science, vol:02, issue:08, Aug 2014
6. Richard Q. Lee, Kue Chun, "Compact miniaturized antenna for 210MHz RFID", NASA Glenn Research Center
7. Manish Kumar, Manish Kumar Sinha, L.K. Bandyopadhyay, Sudhir Kumar., "Design of a wideband reduced size microstrip antenna in VHF/lower UHF range"

National Conference on Current Trends in Engineering, Science and Technology (NACCCTEST- 2018)
Organized by GF's Godavari College of Engineering, Jalgaon
International Journal of Innovations in Engineering and Science, Special Conference Issue, 2018
www.ijies.net

8. Xiao Ding, Bing-Zhong Wang, Guang Ding Ge.

“A Broadband VHF/UHF Double-Whip Antenna”.
IEEE Transaction on antenna and the propagation,
vol:60, issue:02, Feb 2012.

9.A.Anusuya, J. Janetstephy, Prof. G. Jegan, “survey on
various types of microstrip antenna”, American Journal
of Engineering Research, vol:03, issue:11, 2014

National Conference on Current Trends in Engineering, Science and Technology (NACCTEST- 2018)
Organized by GF's Godavari College of Engineering, Jalgaon
International Journal of Innovations in Engineering and Science, Special Conference Issue, 2018
www.ijies.net

A survey on various traffic management schemes for traffic clearance and emergency vehicles

Niketa P. Chaudhari¹, Vijay D. Chaudhari², Dr. A. J. Patil³, Hemraj V. Dhande⁴

¹ PG Student E& TC department, GF's Godavari College of Engineering, Jalgaon, India, 425001

³Principal, Shri.Gulabrao Deokar College of Engineering, Jalgaon, India 425001

^{2,4} Assistant Professor E& TC department, Godavari College of Engineering, Jalgaon, India, 425001

¹elxniki3194@rediffmail.com

²vinuda_chaudhari@yahoo.co.in

Abstract - Due to growth in a number of vehicles on roadways Traffic congestion on city road networks is one of the main issues to be addressed by today's traffic management schemes causes heavy traffic congestion on the road. Traffic congestion on roads may cause the delay for emergency services (i.e. Ambulance, Firefighter, Police, etc.). Neither manual control by police officers nor using predefined timers has proved effective, but they are still being used in many places. Due to this, these emergency vehicles are not able to reach their destinations in time, resulting in a loss. A traffic light plays an essential role in traffic management. Under the normal state traffic light duration for the path is almost fixed and same for the entire path and emergency vehicle are not considered. A various paper present different schemes that determine traffic volume and set the green light duration for the path. This paper presents a survey on various traffic management schemes for traffic clearance and path clearance of the emergency vehicle. Researchers have used several techniques such as Embedded Systems, Wireless Sensors Network, Intelligent Ambulance and Image Processing for traffic management. These techniques have been discussed thoroughly and comparative analysis has been made.

Key Words: GSM, RFID, IR sensor, IOT.

INTRODUCTION

The number of vehicles is increasing exponentially, but the infrastructure for transportation we have is not sufficient to satisfy their needs. Due to this, valuable time of public is being lost every day. This also leads to huge economic problems. The main problem occurs when this traffic congestion costs the life

of someone. This mainly has a major impact on the vehicles dealing with an emergency situation. It should not be surprising that traffic congestion affects almost all emergency vehicles, which can be too much hazardous to affected people. There isn't any quick solution for this. The government can't continue making roads everywhere. There should be a technical solution to get away with this. There should be a solution by which these emergency vehicles can get their way in midst of traffic and traffic signals. No doubts, the ambulance could not have to be waiting on the traffic junction even when the traffic signal is red. But traffic on road doesn't give a path for an ambulance.

A literature survey has been done according to techniques researchers have used. The techniques described in this paper are Embedded System, Wireless Sensor Networks, algorithmic method, Active RFID and GSM Technology, Intelligent Ambulance and Image Processing. Not only description, but comparative analysis has been done in this paper



Fig. 1 Traffic Congestion in Roadways

LITERATURE SURVEY

In real world there are many traffic management schemes established already and various solutions

National Conference on Current Trends in Engineering, Science and Technology (NACCTEST- 2018)
Organized by GF's Godavari College of Engineering, Jalgaon
International Journal of Innovations in Engineering and Science, Special Conference Issue, 2018
www.ijies.net

to the traffic congestion problems suggested by authors

1. Simple Traffic Management Scheme

This is normal form of traffic management in this scheme, a traffic officer is appointed on each and every intersection of roads; the traffic police controls flow of traffic. A traffic police officer is outlooks in middle of road and monitors flow of traffic. In instance of any traffic congestion the police officer gives signals whether to drive or stop to the vehicle driver. Efficiency of system depends on experience and capability of the person and this



ent system.

Figure 2: Traffic Police at Road Crossing

2. Intelligent Traffic Management System

In order to remove the weakest link (i.e. human) in above system, an automatic traffic management scheme is suggested. This system includes simple three color traffic signal as shown in figure3, which we see every day and on every cross section. Generally for each lane 120 seconds of green light is on. Before green light, yellow light flashes for 20 second, signifying to start your vehicle and be ready to go. For all the time red light is on, ordering each vehicle to stop. This system cannot identify emergency vehicle, it consider all vehicle same time is same for all condition not depend on traffic density. it treats normal car and emergency vehicle same way. So there are probabilities of delay in emergency services. E.g. Delay in reaching hospital by the ambulance in case of traffic congestion. Drivers disobeying signal rules are also headache, sometimes they causes serious accidents.

3. Intelligent Traffic Management Scheme using Wireless Technologies

An improved traffic control system using Wireless Sensor Network (WSN) and using new techniques for controlling the traffic flow sequences based on a new traffic infrastructure have been proposed [1]. These methods are dynamically adaptive to traffic conditions for both single and multiple intersections. A WSN is used as a tool to controlling traffic signals roadways, As emergency vehicle come near to an cross section, it broadcast a signal, for notify traffic signal its presence. As soon as traffic signal receive signal from emergency vehicle it gives green light to that particular lane, in which emergency vehicle is coming. The system is self-configuring and operates in real-time to identify traffic



states and interchange information with other nodes via a wireless communication with self-recovery function

Figure 3: A Sample Traffic Signal

4. Intelligent Traffic Management Scheme based on Image Processing

This scheme includes[2] cameras, which are meant to measure length of traffic in the system. Cameras are mounted on a high pole so they can cover long distance. Video footage covered by camera is analyzed by a computer chip in order to detect object (i.e. car, truck, etc.) on road. Different object detection system are used now days. Cameras are also useful in detection of violation of traffic laws. This very best way to calculate traffic density.[3]In this system camera used for detection of emergency vehicle 1Km from traffic signal. this system is divided in two mode normal mode and blue mode (emergency mode) for emergency mode. for Blue mode indication means coming emergency vehicle

National Conference on Current Trends in Engineering, Science and Technology (NACCTEST- 2018)
Organized by GF's Godavari College of Engineering, Jalgaon
International Journal of Innovations in Engineering and Science, Special Conference Issue, 2018
www.ijies.net

indication they have given additional blue indicator with normal traffic signal Red, Yellow, Green.

5. Green wave system

system for the vehicles has been proposed[4], which was used to allow clearance to the ambulance vehicle by turning all the red lights to green on the path of emergency vehicle by providing whole green wave system. A green wave" is the synchronization of the green phase of traffic signals. With a „green wave" setup, a vehicle passing through a green signal will continue receive green signals as it travels down. The green wave system will also track a stolen vehicle when it passes through a traffic light. The advantage with this system is that GPS inside the vehicle does not require additional power. The drawback of this system is that, when the green wave is disturbed, it causes traffic problem that can be exacerbated by the synchronization.

6. Intelligent Ambulance

[5]Ambulance system comprises of Heart Beat sensor and Temperature sensor. When key is forced, heart beats and temperature values will be directed to default mobile phone number (Hospital Number) using GSM module. In signal there will be two RFID readers which will identify traffic density on two roads. When ambulance is detected on any of the road signal for that lane the traffic light will be set to green. Drawbacks: All ambulances must equip with special instruments other than medical. Some other integration also needs.

7. RFID Based System

The traffic light priority control for emergency vehicle has been proposed Figure4. some problems arised with image processing, The use of RFID for traffic control to avoid problems that usually arise with standard traffic control systems, related to image processing and beam interruption techniques are discussed. RFID technique deals with multivehicle, multilane, multi road junction areas. It provides an effective time management scheme, in which, a active time schedule is worked out in real time for the track of every traffic column. Real-time operation of the system rivals the judgment of a traffic policeman on duty. The quantity of vehicles in each column and the routing are proprieties, upon which the controls and the decisions are done. The shortcoming of this work is that it does not discuss the communication

method used among the emergency vehicle and the traffic signal controller[6].

8. RFID and GPS based System

The focus of this work is to reduce the interruption in entrance of the ambulance to the hospital by automatically clearing the path, in which, ambulance is travelling, before it influences traffic signal, in the path of the ambulance, to green when the ambulance is at a some space (which already decided) from the traffic junction. The use of RFID distinguishes between the emergency and non-emergency suitcases, thus avoiding redundant traffic congestion. The communication between the ambulance and traffic signal post is done through the transceivers and GPS. The system is fully automated and hence not requires human intervention at the traffic junctions. The shortcoming of this system is that it needs all the information about the opening point, close point of the travel. The system may not work, if the ambulance needs to take another route for some reasons or if the starting point is not known in advance[7]

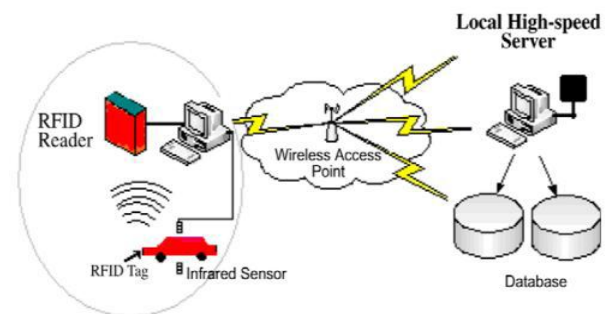

Figure. 4 Framework of RFID technology[6]

9. Intelligent Traffic Light Management System

The main theme behind this scheme[8] is to provide a smooth flow for the emergency vehicles like ambulance to reach the hospitals without delay and thus minimizing the delay caused by traffic congestion. The aim behind this technique is to implement ITLS which will control the traffic lights mechanically in the path of the ambulance. The ambulance is controlled by the control unit which suggest route to the ambulance and

National Conference on Current Trends in Engineering, Science and Technology (NACCTEST- 2018)
Organized by GF's Godavari College of Engineering, Jalgaon
International Journal of Innovations in Engineering and Science, Special Conference Issue, 2018
www.ijies.net

also controls the traffic light according to the ambulance location and thus reaching the hospital safely. sensor use to inform The controller about location of the accident spot through the systems in the vehicle which determined the accident and thus the controller walks through the ambulance to the spot. The vehicle unit installed in the vehicle to senses the accident and sends the location of accident to the controller. The GPS SYSTEM use to finds out the position of the vehicle (latitude and the longitude) which is the location of the accident spot and this data send to the GSM MODULE. The GSM MODULE sends this data to the control unit whose GSM number is already there in the module as an emergency number. In the ambulance unit the controller finds the nearest ambulance to the accident spot and also suggest the shortest path between the ambulance, accident spot and the nearest hospital. The controller then sends this path to the ambulance.

10. Intelligent Decision Making System

This paper address[9] the Major Problems encountered in Conventional Automatic road traffic congestion control system. If the position of vehicle does not come in position of infrared rays then IR sensor would not give response. If the vehicle is under faulty condition in the sort of IR rays then the response given by IR sensor would be inaccurate. If a single camera is used as a vision sensor for obtaining the image of traffic then it is hard to detect the space between two vehicles means projection of camera would be vital feature for measuring the traffic density.

11. Algorithm for Effective Movement of Emergency Vehicles

The proposed method[10] Algorithm used help in selecting Emergency Vehicles from n-number of available Emergency Vehicles, Directing the shortest safest and least crowded path for the vehicles so that it can reach the accident point in least time. To make the movement of emergency vehicles efficient, all traffic control signals should guide traffic to move in favour of clearing the emergency vehicle's route. Check condition are made for assigning priority to emergency vehicles and higher priority emergency vehicles are facilitated first at a particular traffic control signal, apply Dynamic traffic sequence algorithm for the control of traffic sequence

12. Priority Management Using IOT

The paper presents a wise traffic control system to pass emergency vehicles smoothly utilizing RFID and Internet of Things (IoT) applications[11]. The system uses ARM7 Microcontroller (lpc2148), RFID reader to detect the RFID tags fixed to the vehicle. This module uses ZigBee module CC2500. The total system can be controlled through IoT.

Here, each vehicle is provides separate RFID tag. When vehicle comes in the range of RFID reader, it will send the signal to the RFID reader. The RFID reader will track vehicles that have passed determines the priority. The system uses a reader which will provide respective ranges to the system depending on their frequency. During the manufacturing of vehicles, passive tag or transponders are embedded inside the dash board of the vehicle such that it is not easily removable. The manual effort on the part of the traffic policeman is saved by using IoT applications.

Speed control of vehicle at traffic signal also important parameter need to control paper[14] represent different speed control techniques for vehicle.

PROPOSED SYSTEM OVERVIEW

Conventional technologies use the manual or semi manual systems it require human intervention. Manual system uses the manpower. The semi manual methods use the fixed interval traffic light and image processing which do not distinguish between the emergency and other vehicles they consider all same way. My future work focused on If Fire Brigade and Ambulance both or 2 Ambulance or 2 Fire brigade are in traffic signal want to cross same intersection.

In [11] mention algorithm method presents a wise traffic control system to pass emergency vehicles smoothly. [12] Mention two ambulances reach the same lane or different lane on same time then FIFO (First In First Out) will work. But if patient in first coming ambulance does not require urgent care and the patient in next coming ambulance require urgent recovery, so in that circumstances FIFO will not work. in[13] wating time of emergency vehicle is reduced by clearing traffic at intersection here WNS used to collect data about traffic near intersection and here each emergency vehicle gives priority as higher lower and medium but in case of

National Conference on Current Trends in Engineering, Science and Technology (NACCTEST- 2018)
 Organized by GF's Godavari College of Engineering, Jalgaon
International Journal of Innovations in Engineering and Science, Special Conference Issue, 2018
 www.ijies.net

same priority press by hospital authorize person then here give same solution as [12] when two emergency vehicle reaches to intersection. We have to think a new idea for such a problem. Hence propose system we will used Aurdino with IOT (internet of things) it consist of traffic density calculation, shortest path finding, emergency vehicle detection, priority decision section. will utilizing IR sensor and zigbee module with smart display board and internet of things to reach emergency vehicle at destination without delay. The total system will be monitored through IoT.

PROPOSE SYSTEM HARDWARE

Hardware of propose divided is divided into two section Emergency vehicle section and traffic signal section

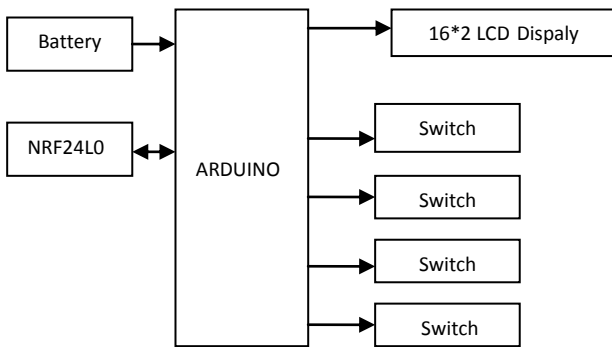

Fig.6 Shows block diagram for emergency vehicle

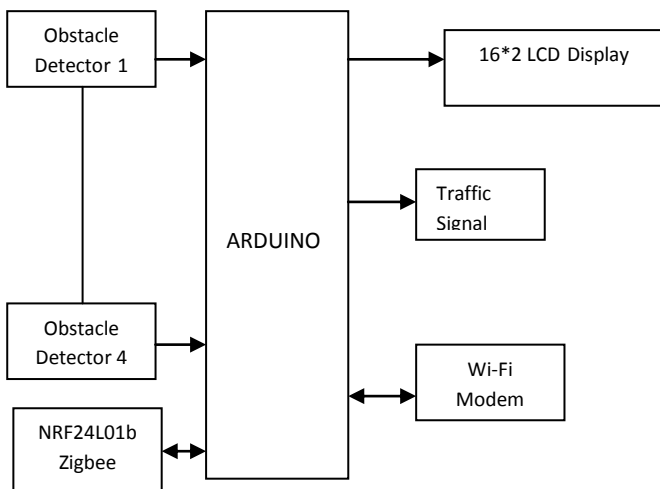

Fig7 Shows block diagram for Signal

In fig.6 emergency vehicle section Zigbee is use to indicated for upcoming emergency vehicle and LCD display assemble with vehicle use for check traffic density of different traffic signal. to inform for upcoming emergency vehicle signal is transmitted from arduino to traffic signal controller.

In fig7 traffic signal section LCD display used to display massages and one extra indicator in addition to red yellow and green to indicate upcoming emergency vehicle. IR sensors placed on road side to calculate traffic density. wi-fi model to send traffic density information over internet. zigbee module will received signal and make green signal on the way of emergency vehicle

COMPARATIVE STUDY OF VARIOUS SYSTEMS

Existing System	Methodology	Comment
Simple method	traffic police officer is outlooks in middle of road and monitors flow of traffic	very inefficient system
Traffic Signal	This system includes simple three color traffic signal	This system cannot identify emergency vehicle
Intelligent Traffic Management Scheme using(WNS)	Emergency vehicle and traffic signal equipped with antenna to inform about upcoming emergency vehicle	Data exchange in between Sensor is not reliable
Image processing	Images extracted from the video are then analysed to detect and count vehicles. Then depending on the signal cycle, time is allotted to each lane	When ambulances arrive from more than one lane system fails, it gives green light to all lanes
Active RFID and GSM Technology	Wireless devices collects data from Active RFID tags, these devices are mounted at roadside. Monitoring station collects all data through GSM, and reply to corresponding traffic signal.	When ambulances arrive from more than one lane system fails, it gives green light to all lanes RFID tags are not reliable because they fail in short period of time
Algorithmic method	Wireless devices collects data from Active RFID tags, these devices are mounted at roadside. Monitoring station collects all data through GSM, and reply to corresponding traffic signal.	Involvement of various communication devices makes implementation costly.

National Conference on Current Trends in Engineering, Science and Technology (NACCTEST- 2018)
Organized by GF's Godavari College of Engineering, Jalgaon
International Journal of Innovations in Engineering and Science, Special Conference Issue, 2018
www.ijies.net

CONCLUSION

After surveying this various traffic management system, we can conclude that traffic management using IOT base approach is suitable for implementation. so there is lot of research going in use of IOT for traffic management. there are some limitations which can be overcome by adding some features from other technologies. In future the system can be enhanced by automation traffic control system and thereby reduce human intervention at the roadways. In this paper, we present the survey of Traffic management methods and also give brief information related to the proposed system. Judging from the existing systems which are currently in use, we can definitely say that, there will be more to improvement needed for the accuracy and efficiency of these systems. We believed that, this article can give a valuable insight into this important research topic and encourage to new research.

REFERENCES

- [1]. Khalil M. Yousef, Jamal N. Al-Karaki, "Intelligent Traffic Light Flow Control System Using Wireless Sensors Networks", *Journal Of Information Science And Engineering* 26, 753-768 (2010)
- [2]. Vikramaditya Dangi, Amol Parab, Kshitij Pawar And S.S Rathod Image Processing Based Intelligent Traffic Controller. *Undergraduate Academic Research Journal (Uarj)*, Issn : 2278 – 1129, Vol-1, Iss-1, 2012.
- [3]. Mode mr. M. Nithyakumar¹, p.aswin², d. Bharathi shree³, m.p.dharmeesh⁴, m. Kalaivani⁵ traffic clearance for emergency vehicles using priority *International Research Journal of Engineering and Technology (IRJET)*
- [4]. K. Mittal And D. Bhandari, "A Novel Approach To Implement Green Wave System And Detection Of Stolen Vehicles," *In Proc. Ieee 3rd Int. Adv. Comput.*, Feb. 2013, Pp. 1055–1059.
- [5]. Sarika B. Kale, And Gajanan P. Dhok" *Design Of Intelligent Ambulance And Traffic Control*", *International Journal Of Innovative Technology And Exploring Engineering (Ijitee)* Issn: 2278-3075, Volume-2, Issue-5, April 2013
- [6]. Nikolkrausz, "Applying Rfid In Traffic Junction Monitoring", *Second Conference Of Junior Researchers In Civil Engineering*.
- [7]. R. Hegde, R. R. Sali, And M. S. Indira, "Rfid And Gps Based Automatic Lane Clearance System For Ambulance," *Int. J. Adv. Elect. Electron. Eng.*, Vol. 2, No. 3, Pp. 102–107, 2013.
- [8]. Mr.S.Iyyappan , Mr.V.Nandagopal "Automatic Accident Detection and Ambulance Rescue With intelligent Traffic Light System" *International Journal Of Advanced Research In Electrical, Electronics And Instrumentation Engineering* Vol. 2, Issue 4, April 2013.
- [9]. Patel.M, Ranganathan.N, "Idutc: An Intelligent Decision-Making System For Urban Traffic Control Applications," *Ieee Transactions On Vehicular Technology*, Pp. 816-829, May 2001.
- [10]. Guddi Singh, Jyoti Singh, A.S Zадgaonkar Richa⁴ Algorithm for Effective Movement of Emergency Vehicles from Traffic Control Signal *Int. Journal of Engineering Research and Application* www.ijera.com ISSN : 2248-9622, Vol. 7, Issue 4, (Part -2) April 2017, pp.09-13
- [11]. Ashit S Chittal, Dinesha P "Priority Management Of Emergency Vehicles Using Iot Approach" *International Journal Of Advanced Research In Computer And Communication Engineering Iso 3297:2007 Certified Vol. 5, Issue 9, September 2016*
- [12]. K. Sangeetha, P. Archana, M. Ramya and P. Ramya, *IOSRJEN 2014. Automatic Ambulance Rescue with Intelligent Traffic Light System*
- [13]. Partha Sarathi Chakrabortya, Arti Tiwaria, Pranshu Raj Sinhab Elsevier 2015 *Procedia Computer Science* 57 (2015) 1384 – 1393 Adaptive and Optimized Emergency Vehicle Dispatching Algorithm for Intelligent Traffic Management System
- [14]. Niketa P. Chaudhari¹, Ishwar S. Jadhav², Chaudhari Vijay D. "Comprehensive Literature Survey on Vehicle Speed Control", *International Journal Of Advanced Electronics & Communication Systems Approved By Csir-Nisair Issn No: 2277-7318*, 21 March, 2017.

National Conference on Current Trends in Engineering, Science and Technology (NACCTEST- 2018)
Organized by GF's Godavari College of Engineering, Jalgaon
International Journal of Innovations in Engineering and Science, Special Conference Issue, 2018
www.ijies.net

PLC BASED AUTOMATIC CAR WASHING

Deepak S. Mali¹ Hitesh M. Wankhade² Tushar S. Ragde³ A. D. Vishwakarma⁴ Vijay Chaudhari⁵

^{1, 2, 3} Student

^{2,3,4} Assistant Professor, ⁴ Assistant Prof, Electrical Engg dept

^{1,2,3,4} Electronic and Telecommunication Department,

Gf'S Godavari College of Engineering, Jalgaon, India, 425001

⁵vc_mp@yahoo.com

Abstract-Currently necessity of main is to live life in automatic way so as to perform task at higher speed. Technology is best interconnecting channel in each part of world with the means of transportation or communication or business which lead to highly increase in the number of cars. time management is directly proportional to reduction of cost for maintenance. The project helps us to use proximity sensor to detect the car. Customer parks the car in particular specified washing area. The main objective of this project is to perform exterior car washing automatically using programmable logic controller integrated with PLC send information like arrival or departure of vehicle. Car washing technique is collection of various things as spraying solution of detergent, cleaning with water then completing task with force air draying fan. the main thing is that in our project the going to used sand filter. again we will use that same water.so that water will be saved.

Keywords- PLC, Nozzles, Solenoid Valve, Pump, Sensors, Relay.

INTRODUCTION

There are many type of car washes like manual car wash were the vehicle is washed by employee, secondly self-service car wash were the customer has to perform the washing and 3rd chemical car wash which use chemical to wash and polishing the car surface etc. in all automobile industry manual car washing need more labor to carry out work which effects in time consumption and also the result may or may not be satisfactory to the customer that depend. So as to overcome these issues, car washing can be done automatically using programmable logic controller (PLC).

PLC is specialize computer used for the control and operation manufacturing process and machinery which function using a programmable memory to store

many instructions and execute function including timing counting, ON/OFF control, data handling, sequencing and arithmetic most of the company in industry used programming as updating or change as per need in programming can be made easy as per requirement many electromechanical relay are observed in current existing system which were replace by programming logic controller. Hence according to it the user can be informing efficiently in case of completion of the process or any emergency. Car washing required components like relay for switch, pipes for spraying water as well as foam water, sprayers which are drive by dc motors, solenoid valve, nozzle, sensors. Control of all this part is made through programming logic control i.e. PLC.

METHODOLOGY

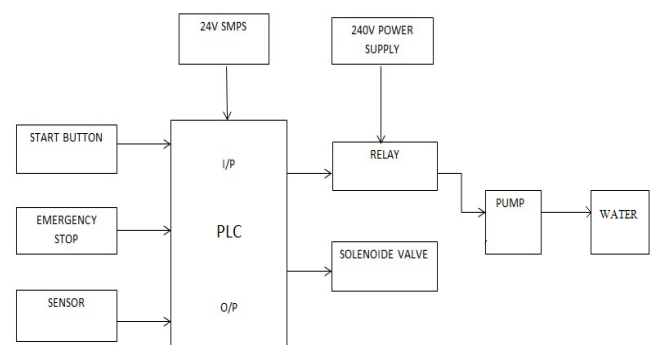

FIG: Block diagram of Automatic car washing using PLC

As seen in the above figure, all the components like Shower, Cleaner, Dryer are connected to the PLC. These components are getting signals from the PLC. Also a start and stop switch is given as an input to the PLC. A Proximity sensor which senses. If the vehicle is in place or not is also connected to the PLC.

National Conference on Current Trends in Engineering, Science and Technology (NACCTEST- 2018)
 Organized by GF's Godavari College of Engineering, Jalgaon
International Journal of Innovations in Engineering and Science, Special Conference Issue, 2018
 www.ijies.net

Details about Components:

- 1) PLC software: -WPLsoft
- 2) Protocol:-Modbus
- 3) Controller:- PLC (Programmable Logic Controller) DELTA
- 4) I/P devices:- Start push button Stop push button infrared Sensor
- 5) O/P devices:- Solenoid Valve Motor Dryer (Fan) Pump

COMPONENT

A] PLC- PLC is a specialized computer used for the control and operation of manufacturing process and machinery. It uses a programmable memory to store instructions and execute functions including on/off control, timing, counting, sequencing, arithmetic, and data handling.[1]

B] Nozzle- Nozzle is often a pipe or tube of varying cross sectional area, and it can be used to direct or modified the flow of fluid (liquid or gas). Nozzles are frequently used to control the rate of flow, speed, direction, mass, shape and/or the pressure of the stream that emerges from them. In a nozzle, the velocity of fluid increases at the expense of its pressure energy. [2]

C] Solenoid Valve-It is an electronically operated device. For our requirements, the two port solenoid valve is the most suitable one. It is generally used to replace a manual valve.[3]

D] Pump-A pump is a basic but important mechanical device that supplies the force to move fluid at specific flow rate.

E] Sensor-A sensor is a tool that need to be metal.

F] Relay-Relay is electrically operated switch in these project we used relay as switch between PLC and Pump.

WORKING

- 1) To detect the car automatically such as infrared sensor.
- 2) Soaping ,Washing ,Rinsing and Drying are performed for a particular time, hence to generate time delay for these output become mandatory.
- 3) To operate this process for souping, washing and drying ,four different timers are used.

- 4) IR sensor detects everything whatever restricts the signal but in load cell, particular low level and high level can be here more effective here IR sensors.[4]

PLC PROGRAM

Here is PLC program to implement an Automatic Car wash, along with program explanation and run time test cases.[6]

List of Input and Output

I:X0 = Start	(input)
I:X1 = Emergency stop	(input)
I:X2 = infrared sensor 1	(input)
I:X3 = infrared sensor 2	(input)
O:Y0 = Pump	(output)
O:Y1 = Water valve	(output)
O:Y2 = Foam valve	(output)
O:Y3 = Indicator	(output)
O:Y4 = Dryer	(output)
T0:0 = Indicator time	(timer)
T1:1 = Washing time	(timer)
T2:2 = Soaping time	(timer)
T3:3 = Washing time	(timer)
T4:4 = Dryer time	(timer)

PLC LADDAR DIAGRAM

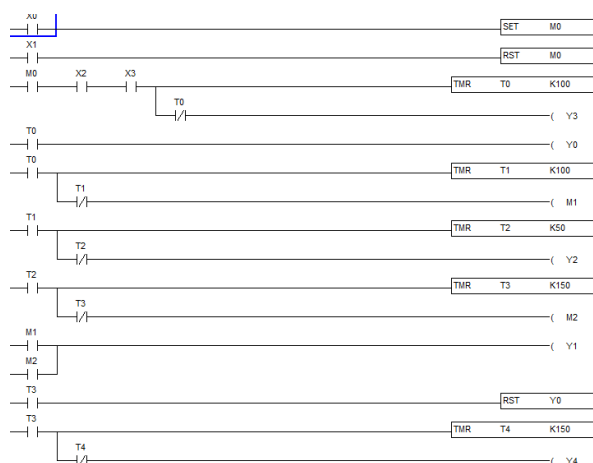

Benefits of Automatic Car Wash

- 1) **Environmental Friendly:** Automatic car washing is considered to be environmental friendly. If you try to wash your car manually at home, it will take around 150 gallons of water to wash your car. Not only that, the dirt and soap can pollute the environment where you live. When you opt for automatic car washing, you can save the consumption of water. Automatic

National Conference on Current Trends in Engineering, Science and Technology (NACCTEST- 2018)
 Organized by GF's Godavari College of Engineering, Jalgaon
International Journal of Innovations in Engineering and Science, Special Conference Issue, 2018
 www.ijies.net

car wash uses only 35 gallons of water and it won't pollute the environment you are living in.

- 2) **Zero Scratches:** When you wash your car at home manually, you normally use dryer for clean car.so when you go for an automatic car washing option, there are zero chances of any scratches.
- 3) **Increases the Value of Your Vehicle:** If you use automatic car washing regularly instead of manual car wash, it can easily increase the market value of your car as your car will be looking new and is free from scratches and marks. Automatic car washing helps to preserve the paint and keeps your vehicle shinning all the time. There are a few automatic car wash equipments that do polishing when performing car wash. This will help your car remain new and free from tiny scratches.
- 4) **Less Wastage of Water:** As you will be using a lot of water when washing your car manually, there will be huge amounts of waste water. If waste waters are not transported correctly, it can cause serious health issues and can pollute your underground water supply. An automatic car washing system uses minimum resources and keeps the environment neat and clean. This project will be filter the water of simple method.
- 5) **Affordable:** Till a few years back, many people believed that automatic car washing was a costly affair. But, in reality, automatic car washing is a more economical option compared to manual car washing. What's more, automatic car washing helps to save your time. It will require hours of effort if you are going for manual car wash. But, automatic car washing can be completed within 5 minutes.[5]

CONCLUSION

This project concludes that Automatic car washing is the best way to keep your car new and free from tiny scratches. There are important purpose will be filter the water of simple method.it will be used for reuse or other purpose. There are many car care providers that use world class automatic car washing equipment that will provide the best car wash at the most affordable rates..

REFERENCES

- [1] Johnson, C. D., *Process Control Instrumentation Technology*, Prentice Hall, 2006. Prof. Mahaska D.A., Bhavthankar R.G, Saindane A. R., Darade D.J.; "PLC Based Car Washing System";*International Journal Of Innovative Research In Electrical, Electronics, Instrumentation And Control Engineering* Vol. 4, Issue 4, April 2016Everett, H.R. (1995).

Sensors for Mobile Robots: Theory and Application. A K Peters, Ltd, MA, USA.

- [2] "Jet nozzles,type Duck"From TROX company,retrieved is October 2013
- [3] ASCO,engineering information solenoid
- [4] WWW.sanfoundary.
- [5] <http://www.firearmcarrental.com/5-benefits-automatic-car-washing-manual-car-wash/>.
- [6] <http://www.sanfoundary.com/plc-program-implement-automatic-car-wash-process>

National Conference on Current Trends in Engineering, Science and Technology (NACCTEST- 2018)
 Organized by GF's Godavari College of Engineering, Jalgaon
International Journal of Innovations in Engineering and Science, Special Conference Issue, 2018
 www.ijies.net

Edge Mesh: A New Paradigm to Enable Distributed Intelligence in Internet of Things

¹Amrita Singh, ²Vijay D. Chaudhari, ³A. D. Vishwakarma, ⁴D.P.Marathe

¹Assistant Professor, P. O. Nahata College, Bhusawal, India, 425201

^{2,3,4}Assistant Professor, E&TC dept, GF's Godavari COE, Jalgaon, India, 425003

²vinuda_chaudhari@yahoo.co.in

Abstract – There has been a paradigm shift in Internet of Things (IoT) of centralized cloud computing to edge computing (or fog computing). developments in ICT have made increment of communication and computation abilities of embedded systems. But they do not use low-level devices for any decision making process. In this paper we propose a new computing paradigm, named Edge Mesh, which classifies decision making tasks among edge devices in the network rather than sending all the data to a centralized server. All the computation tasks are shared using mesh network of edge devices. Edge mesh gives many advantages like distributed processing, low latency, fault tolerance, better scalability, better and privacy. These advantages are used for critical applications, which needs high reliability, real-time processing, mobile support, and context awareness. we give overview and details of edge mesh. Then we describe details including the proposed framework, research challenges and benefits of Edge Mesh and its various application scenarios, including smart home, intelligent transportation system, and healthcare.

Keywords- Edge devices, Internet of Things, distributed intelligence, distributed computing, mesh network.

INTRODUCTION

Internet of Things (IoT) envisions to revolutionize our life by connecting everything around North American nation with one another. IoT has modified the approach we expect regarding our encompassing. IoT affects the majority aspects of our life together with our homes, offices, healthcare, transportation, power grid, logistics, industries, and lots of a lot of areas. Most IoT systems use finish devices for sensing the environment while communication and networking responsibilities square

measure undertaken by gateways and routers. Computation is sometimes done at a centralized server and also the data generated by process is used by some elite devices that act as actuators. Sensing, communication and networking have always been the main target of attention for researchers, however, researchers have currently conjointly started considering problems connected to computation and intelligence. because the variety of devices continues to extend within the returning future, a significant issue can web of Things (IoT) envisions to revolutionize our life by connecting everything around North American nation with one another. IoT has modified the approach we expect regarding our encompassing. IoT affects the majority aspects of our life together with our homes, ofces, healthcare, transportation, power grid, logistics, industries, and lots of a lot of areas. Most of the, wherever there are four main elements i.e. Sensing, Communication, Computation, and feat. IoT envisions embedding of sensing/communication/computation/actuation capabilities in common objects, however, in existing systems, a single device sometimes doesn't supports all the capabilities. Most IoT systems use finish devices for sensing the environment while communication and networking responsibilities square measure undertaken by gateways and routers. Computation is sometimes done at a centralized server and also the data generated by process is used by some elite devices that act as actuators. Sensing, communication and networking have always been the main target of attention for researchers, however, researchers have currently conjointly started considering problems connected to computation and

National Conference on Current Trends in Engineering, Science and Technology (NACCTEST- 2018)
 Organized by GF's Godavari College of Engineering, Jalgaon
International Journal of Innovations in Engineering and Science, Special Conference Issue, 2018
 www.ijies.net

intelligence. because the variety of devices continues to extend within the returning future, a significant issue can be to get helpful info through computation.

METHODOLOGY

1.Acquiring information from continuous and heterogeneous information streams could be a requirement for IoT applications. linguistics technologies offer comprehensive tools and applicable ways for representing, desegregation, and effort information. However, resource-constraints, dynamics, mobility, measurability, and period necessities introduce challenges for applying these ways in IoT environments. we have a tendency to study a way to utilize linguistics IoT information for reasoning of unjust information by applying progressive linguistics technologies. For activity these studies, we've got developed a linguistics reasoning system operative during a realistic IoT surroundings. we have a tendency to value the measurability of various reasoning approaches, together with one thinker, distributed reasoners, mobile reasoners, and a hybrid ofthem. we have a tendency to value latencies of reasoning introduced by completely different linguistics information formats. we have a tendency to verify the capabilities of promising linguistics technologies for IoT applications through comparison the measurability and period response of (various) reasoning approaches with various linguistics information formats. Moreover, we have a tendency to value completely different information aggregation ways for desegregation distributed IoT information for reasoning processes.

2. with the promise of probably unlimited power andscalability, cloud computing (especially infrastructure as a service [IaaS]) supports the preparation of reliable services across many application domains. within the web of Things (IoT), cloud solutions will improve the standard of service (QoS), fostering fostering new business opportunities in multiple domains, like aid, finance, traffic management, and disaster management. accessible mature solutions, like Amazon IoT and Google Cloud Dataflow, demonstrate the success of cloud-centric IoT programming models and resource orchestration techniques.

3. proliferation of web of Things and also the success of made cloud services have pushed the horizon of a brand new computing paradigm, Edge computing, that concerns process the information at the sting of the network. Edge computing has the potential to handle the considerations of time interval demand, battery life constraint, information measure value saving, likewise as information safety and privacy. during this paper, we tend to introduce the definition of Edge computing, followed by many case studies, starting from cloud offloading to sensible home and town, likewise as cooperative. Edge to pass off the thought of Edge computing. Finally, we tend to gift many challenges and opportunities within the field of Edge computing, and hope this paper can gain attention from the community and encourage additional analysis during this direction.

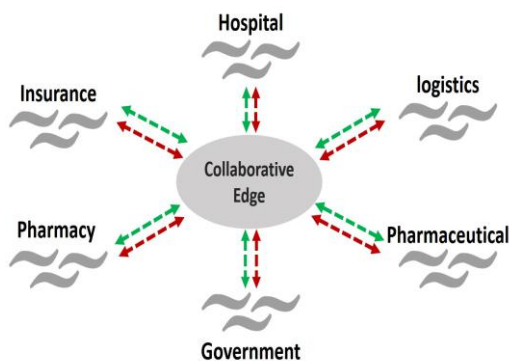

Fig. 1. Collaborative Edge example: connected health.

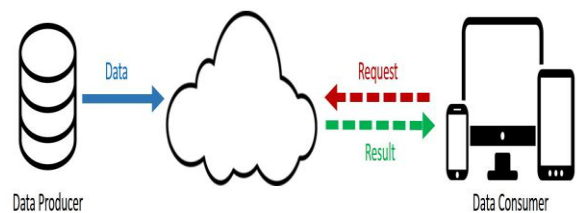

Fig. 2. Cloud computing paradigm.

National Conference on Current Trends in Engineering, Science and Technology (NACCTEST- 2018)
 Organized by GF's Godavari College of Engineering, Jalgaon
International Journal of Innovations in Engineering and Science, Special Conference Issue, 2018
 www.ijies.net

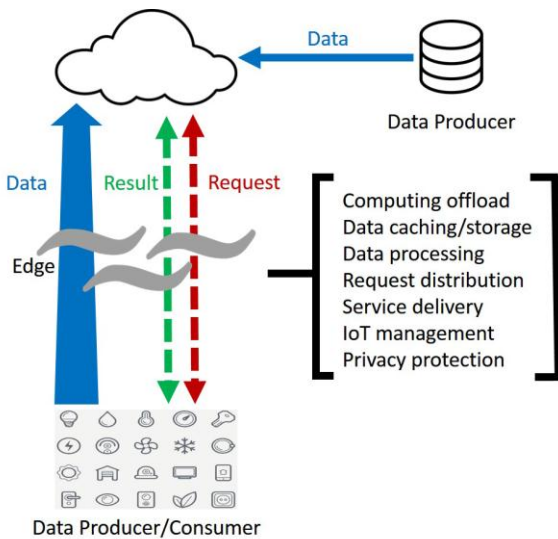

Fig. 3. Edge computing paradigm.

4. In past decades, vital attention has been dedicated to the task allocation and cargo leveling in distributed systems. though there are some connected surveys concerning this subject, every of that solely created a awfully preliminary review on the state of art of 1 single sort of distributed systems. To correlate the studies in variable sorts of distributed systems and build a comprehensive taxonomy on them, this survey primarily categorizes and reviews the representative studies on task allocation and cargo leveling in line with the overall characteristics of variable distributed systems. First, this survey summarizes the overall characteristics of distributed systems. supported these general characteristics, this survey reviews the studies on task allocation and cargo leveling with reference to the subsequent aspects: 1) typical management models; 2) typical resource improvement ways; 3) typical methods for achieving reliability; 4) typical coordination mechanisms among heterogeneous nodes; and 5) typical models considering network structures. for every facet, we tend to summarize the present studies and discuss the long run analysis directions. Through the survey, the connected studies during this space are often well understood supported however they will satisfy the overall characteristics of distributed systems.

5. several applications of wireless detector network (WSN) need the execution of many computationally intense in-network process tasks. cooperative in-network process among multiple nodes is crucial once corporal

punishment such a task because of the strictly forced energy and resources in single node. Task allocation is crucial to apportion the work of every task to correct nodes in Associate in Nursing economical manner. during this paper, changed version of binary particle swarm improvement (MBPSO), that adopts a unique transfer perform and a replacement position change procedure with mutation, is projected for the task allocation drawback to get the most effective answer. every particle in MBPSO is encoded to represent an entire potential answer for task allocation. The task work and property area unit ensured by taking them as constraints for the matter. Multiple metrics, together with task execution time, energy consumption, and network lifespan, area unit thought of a full by planning a hybrid fitness perform to attain the most effective overall performance. Simulation results show the practicableness of the projected MBPSO-based approach for task allocation drawback in WSN. The projected MBPSO-based approach conjointly outperforms the approaches supported genetic rule and BPSO within the comparative analysis.

6. Machine-to-Machine (M2M) paradigm permits machines (sensors, actuators, robots, and good meter readers) to speak with one another with very little or no human intervention. M2M could be a key enabling technology for the cyber-physical systems (CPSs). This paper explores cycle beyondM2Mconcept and appears at futurist applications. Our vision is cycle with distributed deed and in-network process. we have a tendency to describe few specific use cases that inspire the event of the M2M communication primitives tailored to large-scale cycle.M2Mcommunications in literature were thought of in restricted extent to this point. the prevailing work relies on small-scale M2M models and centralized solutions. totally different completely different} sources discuss different primitives. Few existing suburbanized solutions don't scale well. there's a requirement to style M2M communication primitives which will scale to thousands and trillions of M2M devices, while not sacrificing answer quality. the most paradigm shift is to style localized algorithms, wherever cycle nodes build choices supported native data. Localized coordination and communication in networked artificial intelligence, for matching events and robots, were studied for example new directions.

National Conference on Current Trends in Engineering, Science and Technology (NACCTEST- 2018)
 Organized by GF's Godavari College of Engineering, Jalgaon
International Journal of Innovations in Engineering and Science, Special Conference Issue, 2018
 www.ijies.net



Fig. 4. Networked control systems.

7. It feels like charge to attach everything on the planet along via web, however web of Things (IoT) can dramatically amend our life within the predictable future, by creating several “impossibles” potential. To many, the large information generated or captured by IoT is thought-about having extremely helpful and valuable data. data processing can little doubt play a important role in creating this type of system sensible enough to produce additional convenient services and environments. This paper begins with a discussion of the IoT. Then, a short review of the features of “data from IoT” and “data mining for IoT” is given. Finally, changes, potentials, open problems, and future trends of this field are addressed .

8. Recent advancements in radio technology give nice flexibility and increased capabilities in corporal punishment wireless services. one in every of these capabilities that may give important benefits over ancient approaches is that the conception of cooperative computing in wireless networks. With cooperative radio nodes, multiple freelance radio nodes operate along to make a wireless distributed computing (WDC) network with considerably accumulated performance, operational potency, and talents over one node. WDC exploits wireless property to share processing- intensive tasks among multiple devices. The goals square measure to scale back per-node and network resource needs, and change complicated applications not otherwise potential, e.g., image process during a network of little type issue radio nodes. As mentioned during this article, WDC analysis aims to quantify the advantages of distributed process over native process, extend ancient distributed computing (DC) approaches to permit operation in dynamic radio environments, and meet style and implementation challenges distinctive to WDC with the assistance of recently accessible sanctioning technologies, like software system radios and psychological feature radios.

9. In high energy physics, bioinformatics, and different disciplines, we tend to encounter applications involving various, loosely coupled jobs that each access and

generate massive knowledge sets. supposed knowledge Grids request to harness geographically distributed resources for such large-scale data-intensive issues. nonetheless effective programming in such environments is difficult, thanks to a desire to handle a spread of metrics and constraints (e.g., resource utilization, latent period, international and native allocation policies) whereas managing multiple, probably freelance sources of jobs and an oversized range of storage, compute, and network resources. we tend to describe a programming framework that addresses these issues. among this framework, knowledge movement operations could also be either tightly sure to job programming choices or, instead, performed by a decoupled, asynchronous method on the premise of discovered knowledge access patterns and cargo. we tend to develop a family of job programming and knowledge movement (replication) algorithms and use simulation studies to gauge numerous mixtures. Our results counsel that whereas it's necessary to contemplate the impact of replication on the programming strategy, it's not perpetually necessary to couple knowledge movement and computation programming. Instead, these 2 activities may be self-addressed one by one, therefore considerably simplifying the planning and implementation of the general knowledge Grid systems.

CONCLUSION

This paper proposes a replacement computing paradigm, Edge Mesh, that focuses on sanctioning distributed intelligence in IoT. Edge Mesh distributes the full application into sub-tasks that area unit distributed among Edge devices. Edge devices along with routers type a mesh network that is responsible for several computation tasks like storage, processing, data sharing, etc. Edge Mesh tries to integrate best features from Cloud computing, Fog computing, and cooperative computing to supply multi-dimensional options. This paper additionally proposes a computer code framework for Edge Mesh. Software framework is split into 3 levels corresponding to End devices, Edge Mesh, and Cloud.

National Conference on Current Trends in Engineering, Science and Technology (NACCTEST- 2018)
Organized by GF's Godavari College of Engineering, Jalgaon
International Journal of Innovations in Engineering and Science, Special Conference Issue, 2018
www.ijies.net

REFERENCES

- [1] A. I. Maarala, X. Su, and J. Rieki, "Semantic reasoning for context-aware Internet of Things applications," *IEEE Internet Things J.*, vol. 4, no. 2, pp. 461_473, Apr. 2016.
- [2] M. Villari, M. Fazio, S. Dustdar, O. Rana, and R. Ranjan, "Osmotic computing: A new paradigm for edge/cloud integration," *IEEE Cloud Computing*, vol. 3, no. 6, pp. 76_83, Nov./Dec. 2016.
- [3] W. Shi, J. Cao, Q. Zhang, Y. Li, and L. Xu, "Edge computing: Vision and challenges," *IEEE Internet Things J.*, vol. 3, no. 5, pp. 637_646, Oct. 2016.
- [4] Y. Jiang, "A survey of task allocation and load balancing in distributed systems," *IEEE Trans. Parallel Distrib. Syst.*, vol. 27, no. 2, pp. 585_599, Feb. 2016.
- [5] J. Yang, H. Zhang, Y. Ling, C. Pan, and W. Sun, "Task allocation for wireless sensor network using modified binary particle swarm optimization," *IEEE Sensors J.*, vol. 14, no. 3, pp. 882_892, Mar. 2014.
- [6] I. Stojmenovic, "Machine-to-machine communications with in-network data aggregation, processing, and actuation for large-scale cyber-physical systems," *IEEE Internet Things J.*, vol. 1, no. 2, pp. 122_128, Apr., 2014.
- [7] C.-W. Tsai, C.-F. Lai, C.-F. Lai, and L. T. Yang, "Data mining for Internet of Things: A survey," *IEEE Commun. Surveys Tuts.*, vol. 16, no. 1, pp. 77_97, 1st Quart 2014.
- [8] D. Datla *et al.*, "Wireless distributed computing: A survey of research challenges," *IEEE Commun. Mag.*, vol. 50, no. 1, pp. 144_152, Jan 2012
- [9] K. Ranganathan and I. Foster, "Decoupling computation and data scheduling in distributed data-intensive applications," in *Proc. 11th IEEE Int. Symp. High Perform. Distrib. Comput. (HPDC)*, Jul. 2002, pp. 352_358.

National Conference on Current Trends in Engineering, Science and Technology (NACCTEST- 2018)
 Organized by GF's Godavari College of Engineering, Jalgaon
International Journal of Innovations in Engineering and Science, Special Conference Issue, 2018
 www.ijies.net

Survey On Fractal Antenna For Wireless Communication

Sarika Borle¹, Shradhha Patil², Vipul Karankar³, M.N.Patil⁴,

BE Student,

*Department of electronics and telecommunication
 Gf's Godavari college of Engineering Jalgaon, India*

⁴*Assistant Professor in dept. electronics and telecommunication
 Gf's Godavari college of Engineering Jalgaon, India
⁴mahesh_npatil@rediffmail.com*

Abstract – Fractal Antenna are simple, light weight and compact in size. In modern wireless communication system multiband and compact antennas are required. The proposed antenna will be fractal antenna so making this survey on fractal antenna have many future applications. This proposed antenna will be multiband and compact Fractal Antenna with rectangular shape for wireless communication with operating frequency 2.41GHz of basic patch antenna.

Keywords- Fractal, Multiband, Compact.

INTRODUCTION

According to Webster's dictionary a Fractal is defined as being " derived from the Latin 'Fractus' meaning broken, uneven any of various extremely irregular curve or shapes that repeat themselves at any skill on which they are examine "[1]. Day by day, in communication development significance usage is found on phones, tablets, GPs radio navigators and laptop and other wireless devices. Hugely, use of communication devices to getting high performance demands in small size antennas [2]. In study of antennas fractal antenna theory is a relatively new area .Currently, wireless communication has an developing need for more closely and easily carried of communication system. And its characteristics like conformal nature, low manufacturing cost, light weight and easy printed circuit process. It can be comfortably mounted to any kind of surfaces. Fractal antennas are based on concept of a Fractal [3]. Mostly are self similarly or dissimilar concept and the can

achieve multiple frequency bands because of different part of the antennas are similar to each other at some different scale [4]. Fractal Antenna can take on various shape and forms [5]. The fractal antenna not only has a large effective length but the contours of its shape can generate or capacitive or inductive that can help to match the antenna to the circuit [10].

LITRACTURE SURVEY

1] Punte et.al (1996) demonstrated multiband behavior for fractal sierpinski gasket. They observed that this behavior depends on the self-similarity properties of this gasket which may propose on alternative way for the designing of new type of frequency independent and multiband antennas [7].

2] Douglas H. Werner and Suman Ganguly (2003) presented the overview of fractal antenna engineering research. They described the combination of fractal geometry with electrodynamics and have elaborated the mathematical formulation [4].

3] Wen-Ling Chen et.al (2009) suggested a wide fractal shaped slot for enhancement of bandwidth using micro strip feeding technique. They experimentally studied the relation between the iteration order, iteration factor and bandwidth of the fractal shape. Experimentally results show that it achieved 9.2dB gain bandwidth of 1.59 GHz which indicates that the impedance bandwidth of this proposed fractal can attain an operating bandwidth of 2.4GHz having operating frequencies which is nearly 3.5

National Conference on Current Trends in Engineering, Science and Technology (NACCTEST- 2018)
Organized by GF's Godavari College of Engineering, Jalgaon
International Journal of Innovations in Engineering and Science, Special Conference Issue, 2018
www.ijies.net

times that of a conventional micro-strip-line-fed antenna [7].

4] Yin-kan Wang (2011) Fractal antennas have been shown to possess highly desirable properties, including the compact size. A general sierpinski carpet called the sierpinski carpet is proposed in this paper [8].

5] Saurabh Kohli et, al (2013) demon started. I shaped multiband fractal antenna by application of three iteration on antenna , the resulting antenna resonates at 4.7GHz ,6.5GHz and 7.7GHz , 8.5GHz respectively having bandwidth 150MHz ,135MHz ,520MHz and 12GHz .Its applications include defense and secure communication [7].

6] Mahesh Kumar N. Patil, Bhagwan S. Sharma (2014) Antenna with low profile, compact size, multiband are in great insist in modern telecommunication system. Fractal antennas are simple, light weight and compact in size. Multiband antenna offers multiple telecommunication service in to single device [1].

7] Parveen Luthra (2016) A design of rectangle patch antenna with fractal slots for multiband application for designing the antenna FR4 epoxy substrate with thickness 1.6mm and relative permittivity of 4.4 is used a substrate . The resonant frequency used for designing the proposed antenna is 2GHz [9].

METHODOLOGY

Many methods are available out of that method moment (full wave solutions) can be used for proposed antenna. There are mainly two methods for feeding contact and noncontact out of which contact method i.e. micro-strip line feed will be used to match proper impedance with antenna. Also suitable substrate can be used for proposed antenna .The proposed antenna is fractal and basic patch having operating frequency of 2.41 GHz. Such antenna can be used for wireless communications.

SELECTION OF SOFTWARE

FEKO, IE3D, HFSS, and CST this software's are available for antenna design. Out of these suitable software can be selected.

CONCLUSION

After making this literature survey it observed that compact and multiband antennas are in demand so going to design fractal antenna which will be compact and multiband in nature.

ACKNOWLEDGEMENT

The authors are thankful to Mr. M. N. Patil sir and Electronics and Telecommunication Department for providing valuable suggestion for this work.

REFERENCES

- [1] Mahesh Kumar Ninu Patil, Bhagwan Swaroop Sharma. *Multiband and Fractal Antenna for Wireless Communication*, July 2014.
- [2] Ramesh Garg, Prakash Bhatia, Inder Bahl and Apisak Ittipiboon, *Microstrip Antenna Design Handbook*, Handbook ,Artech House, 2000.
- [3] B.B.Mandelbrot, " *The Fractal Geometry Of Nature*, "Newyork,W.H.Freeman,1983.
- [4] D.H.Werner and Ganguly, "An overview of Fractal Antenna Engineering Research,"*IEEE Antennas and Prorogation Magazine*, vol 45.no.1,pp, 38-57,2003.
- [5] C P. Baliarda, J .Romeu and A. Cardama",*The Koch Monopole: A small fractal antenna*", *IEEE Trans Antenna & propagation*, vol 48,pp.1773-1781,November 2000.
- [6] Dipakkumar J.Barasar,Prof.Jayeshkumar C.Prajapati,Ankitkumar M. Dethalia ".*Multiband Fractal Antenna* ,July-2012.
- [7] Amanpreet Kaur, Gursimaranjit Singh," *A review paper on Fractal Antenna Engineering*2014.
- [8] Yin-Kun Wang Jian-Shu Luo and Yin Li elissa, "Investigation on the K-Sierpinski carpet fractal antenna "2011 cross strait Quid-Regional Radio Science and Wireless Technology Conference, July 26-30,2011 978-1-4249-9793-51111, 2011 IEEE
- [9] Parveen Luthra. *A Design of Rectangular Patch Antenna with fractal slots for multiband application* , March 2016.
- [10] Nemanja Poprzen, mico Gacanovic. *Fractal antennas: Design , Characteristics and application*.

National Conference on Current Trends in Engineering, Science and Technology (NACCTEST- 2018)
 Organized by GF's Godavari College of Engineering, Jalgaon
International Journal of Innovations in Engineering and Science, Special Conference Issue, 2018
 www.ijies.net

Energy Efficient Home Automation Based on IoT Using Arduino Application

Venkat P. Patil¹, Umakant Bhaskar Gohatre², Mandar N. Bodane³, Abhishek Ramakrishnan⁴

^{1, 2, 3, 4} Department of Electronics and Tele communication Engineering, Mumbai University, Mumbai, India 400-701

¹bkvpp@rediffmail.com

Abstract – A shrewd home is the private expansion of building computerization. It at first included the control and mechanization of frameworks that guarantee human solace, for example, lighting, warming, ventilation, cooling and security. As of late, it has developed to include most home apparatuses that utilization Wi-Fi for remote observing. Mechanical advancement has upgraded the universality of brilliant home frameworks bringing about stride ways of life. Business home mechanization frameworks are still exorbitant to a larger part of the center and lower class families. With the rise of modest microcontrollers, similar to the Arduino, has empowered the usage of brilliant home frameworks, fusing the lion's share of highlights to introduce in business frameworks. In this paper, we exhibit an exceedingly adaptable, minimal effort and multi-faceted home mechanization framework in view of Arduino microcontroller that is fit for coordinating machine and hardware computerization, warm solace control and vitality administration. The task expects to give an effective, ease computerized vitality administration framework for houses. It likewise gives an office for reconnaissance of the house. The framework has been assembled in the wake of assessing the utility highlights of reconnaissance and vitality administration frameworks accessible at show and is an endeavor to enhance these highlights. Deliberately giving a cost - compelling answer for vitality administration in the family, it likewise gives highlights to oblige catastrophic events like fire. The framework is constructed on an Arduino UNO microcontroller board and uses embedded C as the programming dialect which gives an office of less demanding coding for new elements.

Keywords- *Arduino, Radio-frequency identification, Global system for mobile communication, Ultrasonic sensors.*

I. INTRODUCTION

In this 21st century, with increasing crime rates, everyone wants to protect one's assets. People want security when they are away from home. This home security system provides advanced security for the home owners. Electricity is central of all the activities in the modern society. Energy related issues in present day are a big

problem and still there are many instances where people are in a hurry and forget to switch OFF the lights and fans. In such situation, a system that saves electricity is of great use. The system incorporates twin features of improving energy efficiency and providing surveillance at low cost. Many a times we are in hurry and wish that all the doors are locked and security is ensured. But to manually re-check each door will consume a lot of time and the same is true for electrical equipment. In such case there is a possibility that the lights or fans might have remained ON which will waste the electricity when not in use. To ensure all this when people aren't around at home, double security along with an energy efficient system can be successfully used. Customary houses have dependably developed with time to cook for the changing needs of individuals as far as security also, comfort. These days, individuals need to do assignments as rapidly, productively and essentially as it can be with the slightest measure of exertion. This need can be effortlessly met by changing over 'typical homes' into savvy ones by actualizing a home computerization framework. Home computerization comprises of programmed control of lighting, temperature and different machines, security. Including security frameworks, home excitement frameworks, housekeeping and cultivating frameworks. Such frameworks are intended to improve comfortable accommodation with security as vital product by coordinating sensors that will screen different parameters and actuators that will perform foreordained undertakings. As of late, the approach of effective electronic gadgets combined with significant advancement accomplished in the field of data and corresponding advancements have prompted a critical development in home mechanization. Pervasive advancements have empowered the keen idea to be stretched out to incorporate setting mindful and influential mechanization.

II. METHODOLOGY

The system consists of a voice recognition system which controls the switching of lights, the opening and closure of windows, gas leakage detection as well as the operation of an automatic folding bed. In order to accurately manage these functions, it is crucial to continuously monitor a number of parameters such as

National Conference on Current Trends in Engineering, Science and Technology (NACCTEST- 2018)
 Organized by GF's Godavari College of Engineering, Jalgaon
International Journal of Innovations in Engineering and Science, Special Conference Issue, 2018
 www.ijies.net

temperature, humidity, rain, gas leakage, presence of people in the room, and day or night condition. For this purpose, a light intensity sensor, a temperature and humidity sensor, a motion sensor, a gas and flame sensor, and a rain sensor are integrated in the system.

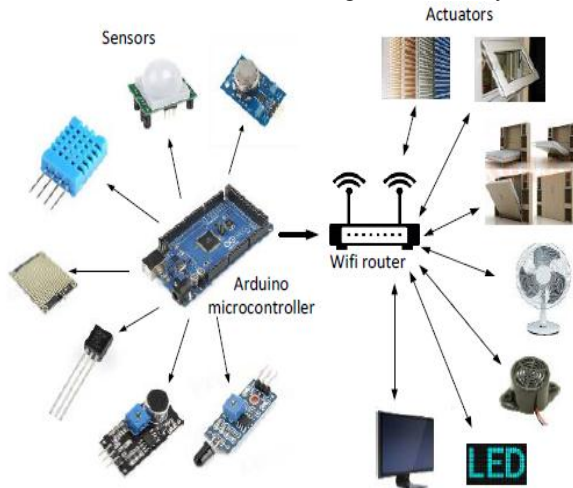

Fig. 1: Block diagram representation of system

The important data acquired by these sensors are displayed on an LCD screen to provide feedback to the user about the status of the observed parameters. The data is also processed by a microcontroller which accordingly sends commands to various actuators to take appropriate action depending on the values of the controlled conditions. In this context, a servo motor is used for controlling the opening and closure of the window while a stepper motor activates the deployment of the folding bed. A fan provides ventilation, a buzzer sounds an alarm in case of fire or gas leakage detection and LEDs are used to indicate the status of parameters. A blind mechanism reacting to light intensity levels is also implemented. One critical feature of any smart home is a user-friendly means to communicate with the system. The latter must be consistent with their requirements so that users can control the appliances or equipment in their homes easily. Moreover, the system should be readily accessible anywhere and anytime. For this purpose, a Wi-Fi module is installed to control devices via the internet through an Android smart phone or computer. A web portal, enhanced with a one factor authentication system, ensures the authenticity of the home owner. Furthermore, a voice recognition system is integrated in the system to interpret instructions spoken by the user and convert them into commands to be executed. Fig. 1 shows the main building blocks of the system. A microcontroller is at the core of the system. In addition to processing all input signals from sensors and controlling the actuators, it also functions as a micro-web server. Hardware interface modules such as motor drivers and relays are employed to interface the microcontroller with sensors and actuators.

A. Selection of Microcontroller

The microcontroller is at the heart of the smart home Automation system as it manages all its functions. It interprets all data from sensors, processes them and sends appropriate signals to control actuators. Recently, several microcontrollers have emerged on the market, including the Arduino, Smart Sam, Launch Pad, PIC and Beagle Bone. Each one of them has its benefits so that the selection of the appropriate microcontroller for the system must be effected with specific design criteria in mind. Here, the overriding criteria are cost, number of Input/Output (I/O) pins, sensor capability and ease of programming. The Arduino Mega was selected because it has a user-friendly development environment, is affordable and readily available. Besides interesting features like a good memory size and a large number of I/O pins, the Arduino is appealing due to its large support community and extensive set of support libraries and add-on boards that extend its interfacing capabilities. The Arduino Mega development board is based on the ATmega2560 AVR processor. These are the main advantages of the Arduino Mega.

III. DESIGN AND IMPLEMENTATION OF SYSTEM

A. Voice Controlled Lighting System

The Elechouse V3 voice recognition system was used to recognize the commands of the occupants to switch on or off lights. It supports up to 80 voice commands, with a maximum of 7 voice command working simultaneously. The V3 module was chosen as it is Arduino-compatible and the connection is simple. Digital I/O pins 2 and 3 of the Arduino Mega are connected to the Tx and Rx pins of the V3 module. 5V and GND are also provided to the voice module from the Arduino. The V3 module was initially trained with the appropriate voice commands which were subsequently loaded into the recognizer of the module. Once commands are successfully identified, the module sends control instructions to the microcontroller. Accordingly, the latter will actuate a relay to switch the lights on or off. The system is also equipped with a Passive Infra-Red (PIR) that detects the presence of people in the room. In this way, the lights switch off automatically when there is nobody in the room, thereby improving the energy efficiency of the design. The working principle of the PIR motion sensor is based on changes in the infrared level emitted by surrounding objects when a person moves around a room. Such changes can be identified by verifying for a high signal on a signal I/O pin.

The microcontroller is programmed so that it checks for occupancy every 8 seconds. It will only switch off the lights if it does not detect any movement in the room during two minutes in order to prevent

National Conference on Current Trends in Engineering, Science and Technology (NACCTEST- 2018)
Organized by GF's Godavari College of Engineering, Jalgaon
International Journal of Innovations in Engineering and Science, Special Conference Issue, 2018
www.ijies.net

switching off the lights when an occupant is motionless in the room.

B. Internet Controlled Lighting System

An ESP8266 Wi-Fi module is used to control the lights through the internet. This low-cost, stand-alone Wi-Fi module is programmed to use the microcontroller as a webserver. Since the ESP8266 requires a 3.3V power supply and can draw currents up to 300mA, the LM317T external voltage regulator is used to bring down the 5V supply to 3.3V. Occupants can access the hardware modules through the web-server to obtain information about the status of the lights and send commands to switch on or off the lights through the relay connected to the microcontroller. The Wi-Fi module first needs to be registered on an internet network so as to generate an IP address, from where the interface can be accessed.

C. Flame and Gas Sensors

In order to detect fire or leakage of inflammable gases in the house, an MQ-5 gas sensor is connected to the Arduino. This low-cost sensor can perceive a broad range of gases including LPG (Liquid Petroleum Gas), methane and smoke. It contains a tin dioxide filament as gas-detecting material. The latter has a lower conductivity in clear air. Hence, if the inflammable gas concentration increases, the conductivity of the sensor will rise, leading to drop in the filament resistance and an increase in the output voltage. Interfacing the sensor with the Arduino requires connecting its D0 output to a digital I/O pin of the microcontroller. The GND and 5V pins of the MQ-5 are supplied from Arduino Mega. Once a flame has been detected, an alarm is triggered and an emergency message is displayed on an LCD screen.

D. Automatic Window

The extent of cross-ventilation in the smart house is controlled by adjusting the opening or closing of windows. A servomotor, connected to the microcontroller through a relay, moves the window through a gearing system. The voice recognition system is extended to the window opening control to provide the user with the possibility of controlling the windows in the house without having to move. This feature is particularly very beneficial to elderly and handicapped people. The windows are further equipped with a FC-37 rain sensor which activates their closure automatically when it starts raining.

E. Automatic Ventilation System

A DHT22 temperature and humidity sensor constantly monitors the temperature and the percentage of humidity in the room. Pin 2 of the sensor is connected to a digital I/O pin of the Arduino through a 1k Ω pull-up resistor, with its 5V and GND provided from the Arduino Mega.

When the values of temperature or humidity read by the sensor reach a level above set thresholds of 25°C and 70% respectively, the ventilation system starts automatically. The threshold values may be changed depending on the comfort requirements of the user. The ventilation system consists of a fan that is controlled by the Arduino Mega through a relay. The ventilation system has PIR motion sensor integrated in it so that when the room is unoccupied, the fan turns off automatically. Occupancy detection follows the same principle as that described in Section IV A.

F. Automatic Folding Bed

An automatic foldable bed was also designed and implemented in the smart house. Smart furniture is yet another aspect of smart homes that has gained increasing attention recently. It refers to an intelligently designed piece of furniture that not only can serve for multiple purposes but also represents good space management. In the present case, when the residents do not need the bed during the day, it may be folded up against the wall to give more space in the room. Moreover the folded bed can also be used as storage furniture. The bed mechanism can be operated by both voice commands and pushbuttons. An emergency stop button is also installed in case of any incident. A stepper motor connected to the microcontroller via a driver actuates the retraction and deployment of the bed as it provides smooth and accurate motion. Gearing equipment is used to reduce the rating of the motor, thus requiring less power.

G. Automatic Blinds

An automatic blind which responds to different light intensity level was also integrated in the system. It opens and closes automatically depending on intensity of light sensed by a Light Dependent Resistor (LDR). The blind mechanism is programmed so that it can recognize three different states according to three ranges of light intensity: "Night", "Average Daylight", and "Too Bright". Their corresponding lux ranges are: 0 -250, 250 - 650 and 650 -1000 respectively. The position of the blinds with respect to the horizontal corresponding to each state is: 0°, 65° and 30° respectively. The LDR constantly monitors light intensity level. The microcontroller determines the state of the blinds on the basis of the LDR output. When there is no change of state, the blinds remain in their initial position.

Table 1- Different parameters values

Sr. No.	Parameters	values
1	Operating Voltage	5 V
2	Digital I/o Pins	54

National Conference on Current Trends in Engineering, Science and Technology (NACCTEST- 2018)
 Organized by GF's Godavari College of Engineering, Jalgaon
International Journal of Innovations in Engineering and Science, Special Conference Issue, 2018
www.ijies.net

3	PWM Digital I/o Pins	14
	Analog input pins	16
	DC Current per Input pins	40mA
	DC Current per 3.3 V pins	50mA
	Flash Memory	256 KB
	SRAM	8 KB
	EEPROM	4 KB
	Clock Speed	16 hz

IV. RESULT

Each sub-system was implemented and tested separately in the first instance. Subsequently, all the features were integrated into a single home automation system that provides its occupants with improved security, a better standard of living, enhanced energy efficiency and an environment adapted for the elderly and physically disabled. The system was tested exhaustively and various circumstances were simulated to ensure the home automation system works as intended. The voice recognition module was able to recognize voices after a single training session. Commands were successfully implemented by the system, whether they were provided through spoken words, switches, push-buttons or a smart phone via the web-server.

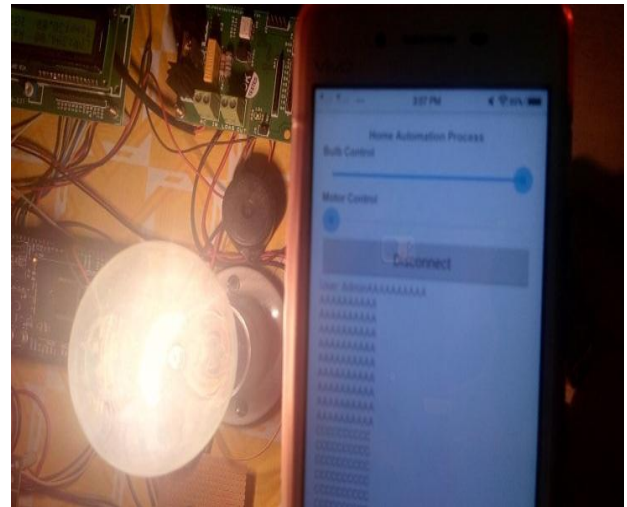

Fig 3: Output at High Light Intensity Level



Fig 4: Running Fan at high speed

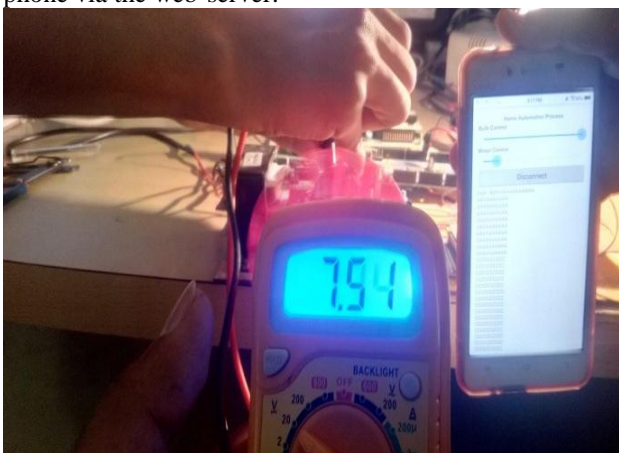

Fig 2: Running Fan at low speed

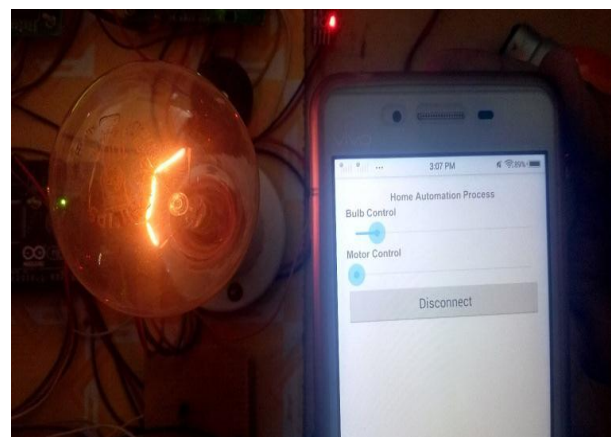

Fig 5: Output at Low Light Intensity Level

National Conference on Current Trends in Engineering, Science and Technology (NACCTEST- 2018)
 Organized by GF's Godavari College of Engineering, Jalgaon
International Journal of Innovations in Engineering and Science, Special Conference Issue, 2018
 www.ijies.net

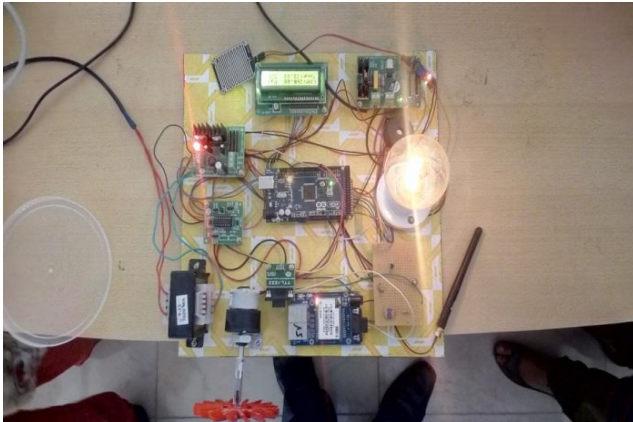

Fig 6: Results of Home Automation Using Android

V. CONCLUSION

This undertaking proposes an easy, secure, generally open, auto-configurable & remotely controlled arrangement. The approach talked about in the paper is unique and has accomplished the stamp to control home machines remotely utilizing the Wi-Fi innovation to interface framework parts, fulfilling client needs and necessities. Wi-Fi innovation proficient arrangement has ended up being controlled remotely, giving home security. Also it is simple when contrasted with the past frameworks. The framework plan and design were talked about, and model exhibits the essential level of home machine control and remote checking that has been actualized. At last, the proposed framework is better from the adaptability perspective to financially accessible home computerization frameworks.

REFERENCES

- [1] Atukorala K., Wijekoon D., Tharugasini M., Perera I., Silva C., (2009), "SmartEye Integrated Solution to Home Automation, Security and Monitoring Through Mobile phones", Next Generation Mobile Applications, Services and Technologies, IEEE Third International Conference on, pp.64-69.
- [2] Zhai Y., Cheng X., (2011), "Design of Smart Home Remote Monitoring System Based on Embedded System", Control and Industrial Engineering, IEEE 2nd International Conference, pp.41-44 .
- [3] Gurek A., Gur C., Gurakin C., Akdeniz M., Metin S. K., Korkmaz I., (2013), "An Android Based Home Automation System", High Capacity Optical Networks and Enabling Technologies, IEEE 10th International Conference on, pp.121- 125.
- [4] Tan K. K., Lee T. H., Soh C. Y., (2002), "Internet Based Monitoring of Distributed Control Systems an Undergraduate Experiment", Education, IEEE Transactions on, vol.45, no.2, pp.128-134.
- [5] Umakant B. Gohatre, Prof. V. D. Chaudhari, Dr. K. P. Rane "Rasp-Pi based Remote Controlled Smart Advertising of Still and Moving Images." in International Journal of Engineering and Computer Science ISSN: 2319-7242, Volume 4 Issue 9, September 2015, Page No. 14449-14457. DOI: 10.18535/ijecs/v4i9.67.
- [6] R.Naresh Naik , P.Siva Nagendra Reddy, S.Nanda Kishore and K.Tharun Kumar Reddy published a Paper Titled "Arduino Based LPG gas Monitoring & Automatic Cylinder booking with Alert System" in IOSR Journal of Electronics and Communication Engineering (IOSR-JECE) , Volume 11, Issue 4, Ver. I (Jul.-Aug .2016), PP 06-12 e-ISSN: 2278-2834,p- ISSN: 2278-8735.
- [7] Yükksekaya B., Kayalar A. A., Tosun M. B., Özcan M. K., Alkar A. Z., (2006), "A GSM, Internet and Speech Controlled Wireless Interactive Home Automation System", Consumer Electronics, IEEE Transactions on, vol.52, no.3, pp.837-843.
- [8] Umakant Bhaskar Gohatre, Prof. V. D. Chaudhari "Digital Advertising of Still and Moving Images using Raspberry PI" in International Journal of Engineering Research & Technology, ISSN: 2278-0181, Volume 4, Issue 02, February 2015.
- [9] Yamazaki T., (2006), "Beyond The Smart Home", Hybrid Information Technology, IEEE International Conference on, vol.2, pp.350-355.
- [10] Ogawa M., Tamura T., Yoda M., Togawa T., (1997), "Fully Automated Biosignal Acquisition System For Home Health Monitoring", Engineering in Medicine and Biology Society, IEEE Proceedings of the 19th Annual International Conference on, vol.6, pp.2403-2405.
- [11] Sriskanthan N., Tan F., Karande A., (2002), "Bluetooth Based Home Automation", Microprocessors and Microsystems, Elsevier Science B.V. vol.26, no.6, pp.281-289.
- [12] Al-Ali A. R., Al-Rousan M., (2004), "Java Based Home Automation System", Consumer Electronics, IEEE Transactions on, vol.50, no.2, pp.498-504.
- [13] Umakant Bhaskarrao Gohatre, Venkat P. Patil "Comparative Estimation of Trajectory based Tracking System and Impact of Subsequent on Projectile Course in 3-D Utilizing Motion Technique" International Journal of Engineering Technology Science and Research, IJETS, Volume 4, Issue 9, ISSN 2394 – 3386, September 2017
- [14] Deepti S., (2014), "Home Automation System with Universally Used Mobile Application Platform", IOSR Journal of Electronics and Communication Engineering, vol.9, no.2, pp.01- 06.
- [15] Piyare R., Tazil M., (2011), "Bluetooth Based Home Automation System Using Cell Phone", Consumer Electronics, IEEE 15th International Symposium on, vol.45, no.3, pp.192-195.
- [16] Javale D., Mohsin M., Nandanwar S., Shingate M., (2013), "Home Automation and Security System Using Android ADK", International Journal of Electronics Communication and Computer Technology, vol.3, pp.382-385.

National Conference on Current Trends in Engineering, Science and Technology (NACCTEST- 2018)
Organized by GF's Godavari College of Engineering, Jalgaon
International Journal of Innovations in Engineering and Science, Special Conference Issue, 2018
www.ijies.net

[17] EASAMBATTU, Thejaswini; REDDY, P. Ajay Kumar; RAMAIAH, G. N. Kodanda. Controlling Home Appliances through GSM Modem and Internet. International Journal of Electronics Engineering Research, [S.l.], p. 1-7, oct. 2013. ISSN 0975- 6450

[18] Mahendran.N, Geo Joe Mathai and Veenesh. M.U, "Multiple Sensor Feeding Supported Building Automation System Using Arduino Platform With Exposure of 802.15.4 Functionalities", International Journal of Engineering Trends and Technology, Vol.4 Issue 2, 2013.

[19] "Inspiring Energy Conservation Through Open Source Power Monitoring and In-Home Display", IEEE Power & Energy Society General Meeting (PES GM 2013)

[20] Sourabh Dey, "Energy Harvesting and Home Automation", International Journal of Scientific Research Engineering & Technology (IJSRET), Conference Proceeding, pp.14-15, ISSN: 2278-0882, March 2015.

[21] Abhay Kumar, Neha Tiwari, Energy Efficient Smart Home Automation System, International Journal of Scientific Engineering and Research (IJSER), Volume 3 Issue 1, ISSN (Online): 2347-3878, January 2015.

[22] P. Satya Ravi Teja, V. Kushal, A. Sai Srikar and K. Srinivasan, "Photosensitive security system for theft detection and control using GSM technology", Signal Processing and Communication Engineering Systems (SPACES), International Conference, INSPEC Accession Number: 14984675, 2015.

[23] K. N. Ramli, A. Joret and N. H. Saad, "Development of Home Energy Management System Using Arduino", Second International Conference on Technological Advances in Electrical, Electronics and Computer Engineering, ISBN: 978-0-9891305, pp. 4-7, 2014.

[24] Viraj Mali, Ankit Gorasia, Meghana Patil, and. P.S.Wawage, "Home Automation and Security using Arduino Microcontroller", International Journal of Research in Advent Technology (E-ISSN: 2321-9637) 214- 217, 2016.

National Conference on Current Trends in Engineering, Science and Technology (NACCTEST- 2018)
 Organized by GF's Godavari College of Engineering, Jalgaon
International Journal of Innovations in Engineering and Science, Special Conference Issue, 2018
 www.ijies.net

Development of Real Time Performance Evolution in Moving Object Identification Approach for Higher Foreground Deep Detection Features

Umakant Bhaskarrao Gohatre¹, Venkat P. Patil², C. Ram Singla³

^{1,2} Department of Electronics and Tele communication Engineering, Mumbai University, Mumbai, India 400-701

¹umakantbhaskar@gmail.com

Abstract – Exact and quick infrared (IR) closer view protest identification is a standout amongst the most noteworthy issues to be unraveled due to its essential significance for IR target acknowledgment, IR exact direction, IR video observation, et cetera. A typical approach for such errands is "foundation subtraction," which means to recognize forefront question through foundation displaying. In this way far, numerous foundation subtraction techniques have been proposed furthermore, have accomplished great execution. Be that as it may, due to the extraordinary qualities of IR pictures, a couple of calculations are reasonable for IR closer view question discovery. As of late, highlights learned from convolution neural systems (CNNs) have illustrated extraordinary achievement in numerous vision undertakings, for example, arrangement and acknowledgment. In this letter, we propose a novel multi scale completely convolution organize engineering for IR closer view protest discovery. Given a CNN demonstrate retrained on a vast scale picture informational collection, our strategy takes yield highlights from various layers of the system. With highlights from different scales, our element portrayal contains both class level semantics and fine grain points of interest. The test comes about on IR picture successions demonstrate that the proposed technique accomplishes the cutting edge execution while working progressively.

Keywords- Background subtraction, infrared (IR) object detection, IR video surveillance, multiscale fully convolutional network (MFCN).

I. INTRODUCTION

(IR) foreground object detection is important due to its wide range of applications, such as IR target recognition, IR precise guidance, and IR video surveillance [1], [2]. Compared with visible images, foreground object detection in IR images can be more complex because of many special characteristics, such as low signal-to-noise ratios, low contrast, lack of structure, such as shape and texture information, high uncertainty, and high ambiguity of pixel values [3]. All these factors make the

detection of IR foreground object more difficult and challenging. Current IR foreground object detection methods are primarily based on state-of-the-art background subtraction algorithms. In the past few decades, a multitude of background subtraction methods for visible images has been proposed and has achieved good performance [4]. Most of these methods primarily manifest in the following two aspects: more advanced background models [5]–[8] and more complex feature representations [9]–[12]. However, due to the special characteristics of IR images and the differences between the features of IR and visible objects, a few background subtraction algorithms are suitable for IR foreground object detection. Interestingly, deep neural networks have recently drawn much attention in the computer vision community, and deep features obtained from convolution neural networks (CNNs) have been shown to be effective for many computer vision tasks, such as classification and recognition [13], [14]. Despite their popularity, only a few attempts have been made to employ CNNs for background subtraction. The first novel background subtraction method with the use of a CNN was proposed in [15]. In this method, a fixed background model image is first generated through a temporal median operation over several initialization frames. Then, for each pixel, small patches around the pixel extracted from the background image and the input frame combined with its ground-truth label are used to train the CNN model. After the network model is trained, to detect foreground object in a new frame, patches around a pixel are fed through the network and the foreground probability for that pixel is obtained. An improved CNN-based background subtraction was proposed in [16] with a cascade CNN architecture that achieves the state-of-the-art performance. However, these CNN-based methods have several drawbacks. First, all of them are patch-wise-based methods. Extracting the patches is not only time consuming but also results in very rough foreground masks. Second, to classify the foreground or background, only the output of the last layer features is considered in the network. Third, current methods using highly redundant data to train the network cause overfitting problems. The fully

National Conference on Current Trends in Engineering, Science and Technology (NACCTEST- 2018)
 Organized by GF's Godavari College of Engineering, Jalgaon
International Journal of Innovations in Engineering and Science, Special Conference Issue, 2018
 www.ijies.net

convolutional network (FCN) architecture was first proposed in [17] for image segmentation. Compared with patch-wise methods, FCN-based models can capture more local and global context information, which produces more accurate and detailed segmentations. Recent research shows that considering features from different convolutional layers can improve results for different vision tasks [14], [18].

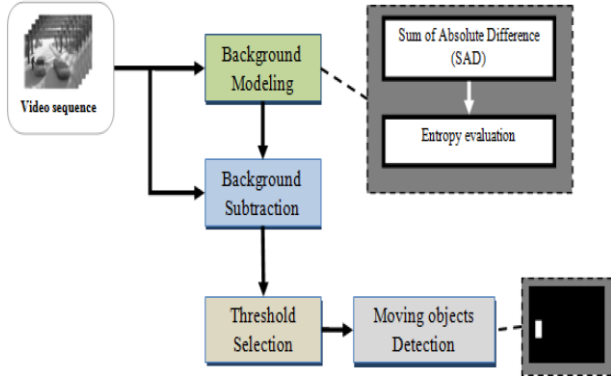

Fig. 1 Flowchart of our proposed approach

The lower layers contain low-level semantic information but retain a higher spatial resolution, while the deep layers capture more high-level semantic information but with less spatial detail. With these considerations in mind, we propose a novel multiscale FCN (MFCN) architecture that takes advantage of different layer features for IR foreground object detection. With the features gained from multiple scales, our feature representation contains both category-level semantics and fine grain details. The experimental results on IR image sequences show that our method achieves both the state-of-the-art and the real-time performance during the detection process. The remainder of this letter is organized as follows.

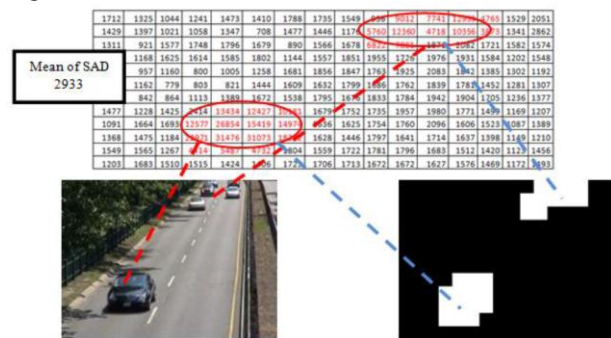

Fig. 2 Detected blocks using mean of SAD values

Section II describes the framework of the proposed MFCN-based IR foreground object detection algorithm. Section III presents the results of the experiments conducted on various IR image sequences compared with other state-of-the-art methods. Finally, conclusions are given in Section IV.

II. MFCN-BASED BACKGROUND SUBTRACTION

In this section, we give a detailed description of the framework for the MFCN-based IR foreground object detection method. Fig. 1 shows the process of the proposed method.

A. Training Data Preparation

To train the network, for each IR image sequence, we take a random subset of 150 input frames with their corresponding ground-truth frames as the training data. After all training input frames and label masks have been collected, a preprocessing operation is performed. As shown in Section II-B, since our network is based on the VGG-16 [19] network, the inputs have a size of $224 \times 224 \times 3$; thus, we must preresize all the training frames to the fixed size of $224 \times 224 \times 3$. Then, a mean subtraction is performed on each pixel. Since we regard the foreground object detection as a binary classification problem in our method, therefore, the corresponding training label frames are of the size of $224 \times 224 \times 2$. The pixel label value is given,

$$y(p) = _1, \text{ if class}(p) = \text{foreground } 0, \text{ otherwise (1)}$$

where p denotes the pixel in the ground truth.

III. NETWORK ARCHITECTURE:

The architecture of the proposed network In contrast to previous work [20], the proposed method does not need to extract the background images. The input of this network is frames from different sequences, and the output is a probability map (one channel, the size of which is the same as the input because a limited amount of training data is available; thus, a transfer learning method is adopted by retraining a deep CNN on a large-scale image data set and then fine tuning the learned features for our task. In this letter, the model is fine-tuned on the VGG-16 [14] network (the dashed box it split the VGG-16 network into five blocks (V1, V2, V3, V4, and V5), with each block containing some convolution and max pooling operations. The sizes of the corresponding output feature maps. It can see that the lower blocks have a higher spatial resolution but contain more low-level local features, while the deeper blocks contain more high-level global features at a lower resolution. Afterward, to gain multiscale features from the different layers, 3×3 convolution kernels are applied to the pretrained blocks. As shown in the second row of, the generated convolutional layers (C1, C2, C3, C4, and C5) are connected to the upper VGG blocks. The output feature maps maintain the same spatial resolution as the upper blocks with 128 channels.

Since foreground object detection is treated as a binary classification problem in this letter, the output masks show a great contrast between the foreground and the background, which means that the features of the foreground and the background in the input frames should also have a large difference.

National Conference on Current Trends in Engineering, Science and Technology (NACCTEST- 2018)
 Organized by GF's Godavari College of Engineering, Jalgaon
International Journal of Innovations in Engineering and Science, Special Conference Issue, 2018
 www.ijies.net

To extract this kind of contrast information, a contrast layer is added behind the output feature layer. The contrast layer is calculated as follows:

$$P_i = C_i - \text{AvgPool}(C_i) \dots \dots \dots (2)$$

Here, AvgPool is the average pooling operation with a kernel size of 3×3 . In Fig. 3, we compare the detection results obtained by FCN architecture which without multiscale features and a new architecture (MFCN_) which without contrast layers. We can see that FCN results contain many holes and unconnected regions, results obtained by MFCN_ are also very coarse, and the boundaries of the foreground object are not well preserved, which makes the final segmented foreground masks much thinner and less accurate. Finally, to exploit multiscale features from multiple layers, a set of deconvolution operations is used to up sample these features, creating an output probability map the same size as the input, as shown in the last rows of. The de convolution kernels have the size of 3×3 and the stride is 2. Instead of upsampling the feature maps with a fixed ratio of {8, 16, 32}, as done in [21] for semantic segmentation, we adopt a stepwise up sampling strategy that produces more refined feature maps.. Then, we up sample the concatenated feature as before and get the new de convolution layer D4. After five stages of deconvolution operations, the feature maps with different scales are integrated and up sampled to the input size. This process can be expressed as follows:

$$D_{i-1} = \text{Deconv}(\text{Concat}(C_i, P_i, D_i)) \dots \dots \dots (3)$$

First, the feature layer C5 is concatenated with its contrast feature layer P5 in the last dimension. Then, the concatenated feature is up sampled by 2 with the de convolution operation. After the new de convolution layer D5 is obtained, it is concatenated with the feature layer C4 and its contrast feature layer

IV. PERFORMANCE EVALUATION:

1) *Quantitative Evaluation:* We compare the proposed method with some other classical and state-of-the-art IR foreground object detection methods, including the following: Cascade CNN [22], IUTIS-5 [22], Sub SENSE [23], KDE [7], SOBS [24], Vi Be [8], and GMM [25]. In Table I, we present a detailed performance comparison. For a specific metric, if a method obtains the best scores, the corresponding value is highlighted in bold. Using the standardized evaluation tool provided in [26], seven metric scores are reported. For the PWC, FNR, and FPR metrics, lower values indicate higher accuracy, while for the recall, specificity, and FM metrics, higher values indicate a better performance. The

results of other methods are from the website.¹ We can see that the proposed method obtains the best performance

in all metrics, especially with its FM score of 0.9870, and outperforms the second best method with a considerable margin. As demonstrated in [16], a method with an FM score above 0.94 and a PWC score below 0.9, the detection results may be considered almost as good as the ground truth, since a simple dilation (or erosion) of one or two pixels of the ground truth may result in an FM score drops from 1.0 to about 0.94. This again shows the efficiency of the proposed method.



Fig. 3 Its initial background of the seven sequences of the SBI data set. First row: image of the sequence and second row corresponding background initialisation frames

2) *Qualitative Evaluation:* To make a better visual comparison of the detection results under different scenarios, we select the following frames: the 1959th frame from the *corridor* sequence, the 3166th frame from the *dining Room* sequence, the 6067th frame from the *lake Side* sequence, the 4470th frame from the *library* sequence, and the 362th frame from the *park* sequence. As shown in Fig. 5, the first column displays the input frames and the second column shows the corresponding ground truth. From the third column to the eighth column, the foreground object detection results are given for the following methods: our method (MFCN), Cascade CNN, IUTIS-5, Sub SENSE, Vi Be, and GMM. Visually, we can see that our results appear superior to those of the other methods and are closest to the ground truth, which is in good agreement with the quantitative evaluation results.



National Conference on Current Trends in Engineering, Science and Technology (NACCTEST- 2018)
 Organized by GF's Godavari College of Engineering, Jalgaon
International Journal of Innovations in Engineering and Science, Special Conference Issue, 2018
 www.ijies.net

Fig. 4 Comparison of background results on the SBI data set: (first row) frame of sequence, (second row) ground-truth, (third row) median, (fourth row) MDPS, (fifth row) ISBS, and (sixth row) our proposed method

3) *Generalization to Other Spectra*: The input of our network architecture is about the size of $224 \times 224 \times 3$, which inspires us to consider whether the proposed method can be generalized to visible videos. We also evaluated the MFCN network on various RGB sequences from the change detection challenge data set [27]. We achieved an average FM score of 0.96, which is slightly worse than the results for the IR images, but better than many other foreground detection algorithms. So we can see that the proposed method has a strong universality[28,29,30]. It can be applied not only to IR images but also to other visible spectral images.



Fig. 5 Various background models generated by each approach in the LS sequence

4) *Real-Time Performance*: Processing speed is a critical factor to be considered before selecting an IR foreground object detection method. During the detection stage, the proposed MFCN model is run on a 4.0-GHz Intel Core-i7 7700 CPU with an NVIDIA GTX 1060 GPU and an Ubuntu 16.04 operating system. The average processing time per frame is 0.0372 s (nearly 27 frames/s), which shows realtime potential [31,32].

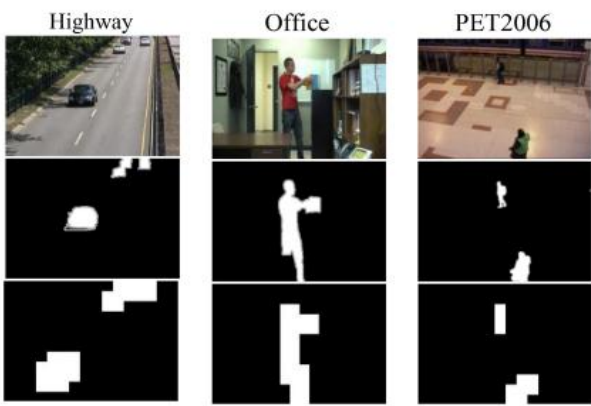

Fig. 6 Results of the proposed method in the change detection data set

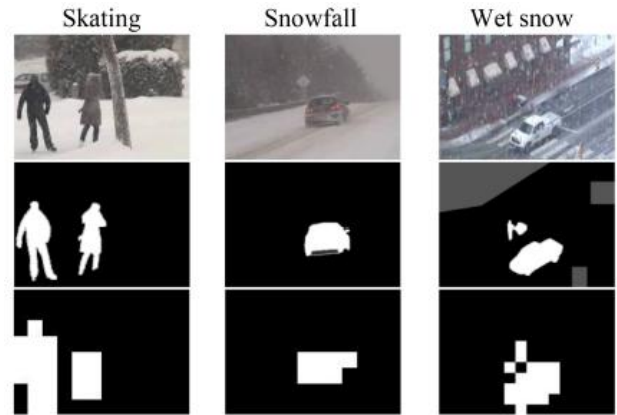

Fig. 7 Results of the proposed method in the change detection data set

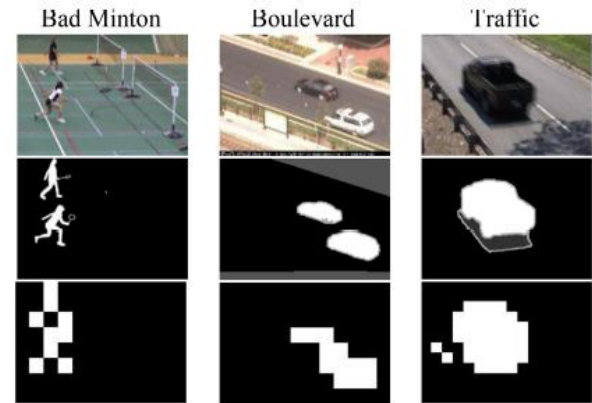

Fig. 8 Results of the proposed method in the change detection data set

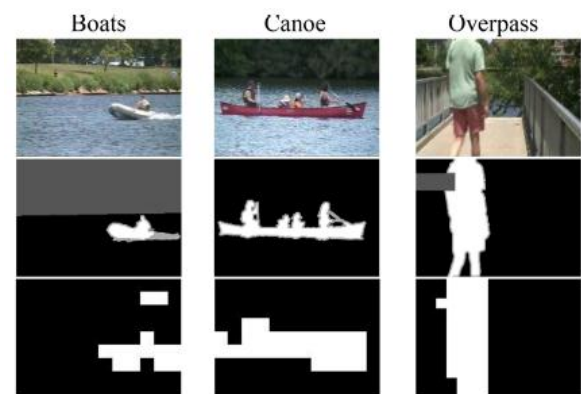

Fig. 9 Results of the proposed method in the change detection data set

National Conference on Current Trends in Engineering, Science and Technology (NACCTEST- 2018)
Organized by GF's Godavari College of Engineering, Jalgaon
International Journal of Innovations in Engineering and Science, Special Conference Issue, 2018
www.ijies.net

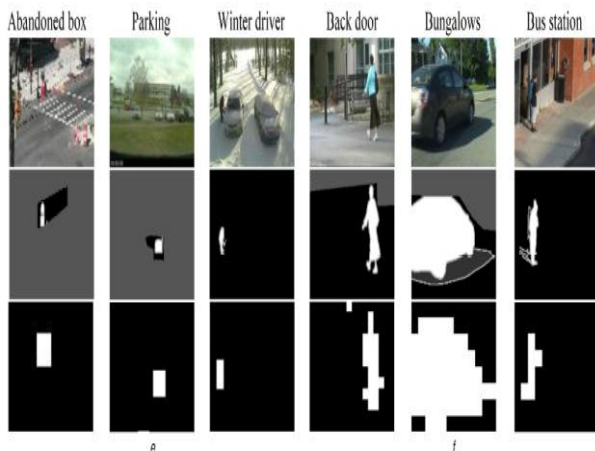

Fig. 10 Results of the proposed method in the change detection data set

Table 1- Overall FM Scores On All IR Image Sequences for different methods

Method	Recall	Specificity	FPR	FNR
MFCN	0.9821	0.9987	0.0001	0.0197
Cascade CNN	0.944	0.9987	0.0067	0.0543
SubSense	0.754	0.9955	0.0045	0.2010
KDE	0.876	0.9986	0.0044	0.1839
SOBS	0.644	0.9924	0.0067	0.3275
ViBe	0.57	0.9956	0.0032	0.3997
GMM	0.54	0.99687	0.0054	0.4295

V. CONCLUSION

This paper exhibits a foundation displaying and moving item identification approach in a video arrangement of scenes containing moving items. The initial steps comprise of partitioning all casing of the grouping into pieces and after that process the SAD between every two sequential pictures. The underlying foundation framed by the squares that have the base SAD. For every approaching casing of the arrangement, each square out of sight will be refreshed utilizing entropy development. The foundation displaying system handles so well the sudden complex lighting changes through the proposed enlightenment change recognition work. The SAD between pieces of the present picture and foundation picture is utilized to create the parallel cover of moving item identification. From the imagined comes about and the measurements esteems, we can conclude that our

approach is viable to recognize moving article as far as quality and amount.

The MFCN architecture for IR foreground object detection is presented. Benefitting from the hierarchical convolution features learned from multiple scales, the proposed method achieves a much higher foreground detection accuracy, which shows the effectiveness of deep features compared with conventional hand-crafted features. Experiments were performed on various IR image sequences, showing that this method outperforms recent state-of-the-art methods and has the potential for real-time applications. Currently, the main limitation of the MFCN is that it is a supervised method and human-constructed ground truths are needed to train the model. However, the MFCN can also be trained with the results produced by other unsupervised methods, but it may reduce the accuracy. As a future work, we plan to combine traditional unsupervised methods and the proposed CNN-based method to compensate each other for better performance.

REFERENCES

- [1] C. Stauffer and W. E. L. Grimson, "Adaptive background mixture models for real-time tracking," in Proc. IEEE Conf. Comput. Vis. Pattern Recognit., Jun. 1999, pp. 246–252.
- [2] M. S. Allili, N. Bouguila, and D. Ziou, "A robust video foreground segmentation by using generalized Gaussian mixture modeling," in Proc. IEEE Conf. Comput. Vis. Pattern Recognit., May 2007, pp. 503–509.
- [3] Vese, L.A., Osher, S.J.: 'Modeling textures with total variation minimization and oscillating patterns in image processing', J. Sci. Comput., 2003, 19, (1–3), pp. 553–572.
- [4] Umakant Bhaskarrao Gohatre, Venkat P. Patil "Comparative Estimation of Trajectory based Tracking System and Impact of Subsequent on Projectile Course in 3-D Utilizing Motion Technique" International Journal of Engineering Technology Science and Research, IJETSR, Volume 4, Issue 9, ISSN 2394 – 3386, September 2017.
- [5] Umakant Bhaskarrao Gohatre, Venkat P Patil, Sanjay Gaur, "Comparative Estimation of Trajectory based Tracking System and Impact of Subsequent on Projectile Course Prediction Techniques", IJCEM International Journal of Computational Engineering & Management, volume 20, Issue 5, ISSN (Online): 2230-7893, September 2017
- [6] Colmenarejo, A., Escudero-vinolo, M., Bescos, J.: 'Class-driven Bayesian background modeling for video object segmentation', Electron. Lett., 2011, 47, (18), pp. 1023–1024
- [7] A. Elgammal, R. Duraiswami, D. Harwood, and L. S. Davis, "Background and foreground modeling using nonparametric kernel density estimation for visual surveillance," Proc. IEEE, vol. 90, no. 7, pp. 1151–1163, Jul. 2002.
- [8] O. Barnich and M. Van Droogenbroeck, "ViBe: A universal background subtraction algorithm for video sequences," IEEE Trans. Image Process., vol. 20, no. 6, pp. 1709–1724, Jun. 2011.
- [9] M. Heikkilä and M. Pietikäinen, "A texture-based method for modeling the background and detecting moving objects," IEEE Trans. Pattern Anal. Mach. Intell., vol. 28, no. 4, pp. 657–662, Apr. 2006.
- [10] S. Liao, G. Zhao, V. Kellokumpu, M. Pietikäinen, and S. Z. Li, "Modeling pixel process with scale invariant local patterns for

National Conference on Current Trends in Engineering, Science and Technology (NACCTEST- 2018)
Organized by GF's Godavari College of Engineering, Jalgaon
International Journal of Innovations in Engineering and Science, Special Conference Issue, 2018
www.ijies.net

background subtraction in complex scenes,” in Proc. IEEE Conf. Comput. Vis. Pattern Recognit., Jun. 2010, pp. 1301–1306.

- [11] P.-L. St-Charles and G.-A. Bilodeau, “Improving background subtraction using local binary similarity patterns,” in Proc. IEEE Winter Conf. Appl. Comput. Vis., Mar. 2014, pp. 509–515.
- [12] P. L. St-Charles, G. A. Bilodeau, and R. Bergevin, “SuBSENSE: A universal change detection method with local adaptive sensitivity,” IEEE Trans. Image Process., vol. 24, no. 1, pp. 359–373, Jan. 2015.
- [13] A. Krizhevsky, I. Sutskever, and G. E. Hinton, “ImageNet classification with deep convolutional neural networks,” in Proc. Adv. Neural Inf. Process. Syst., 2012, pp. 1097–1105.
- [14] K. Simonyan and A. Zisserman. (Sep. 2014). “Very deep convolutional networks for large-scale image recognition.” [Online]. Available: <https://arxiv.org/abs/1409.1556>
- [15] M. Braham and M. Van Droogenbroeck, “Deep background subtraction with scene-specific convolutional neural networks,” in Proc. IEEE Int. Conf. Syst., Signals Image Process., May 2016, pp. 1–4.
- [16] Y. Wang, Z. Luo, and P.-M. Jodoin, “Interactive deep learning method for segmenting moving objects,” Pattern Recognit. Lett., vol. 96, pp. 66–75, Sep. 2016.
- [17] J. Long, E. Shelhamer, and T. Darrell, “Fully convolutional networks for semantic segmentation,” in Proc. IEEE Conf. Comput. Vis. Pattern Recognit., Jun. 2015, pp. 3431–3440.
- [18] M. Danelljan, G. Häger, F. S. Khan, and M. Felsberg, “Convolutional features for correlation filter based visual tracking,” in Proc. IEEE Conf. Comput. Vis. Pattern Recognit. Workshops, Dec. 2015, pp. 58–66.
- [19] M. Abadi et al. (Mar. 2016). “TensorFlow: Large-scale machine learning on heterogeneous distributed systems.” [Online]. Available: <https://arxiv.org/abs/1603.04467>
- [20] S. Bianco, G. Ciocca, and R. Schettini. (May 2015). “How far can you get by combining change detection algorithms?” [Online]. Available: <https://arxiv.org/abs/1505.02921>
- [21] L. Maddalena and A. Petrosino, “The SOBS algorithm: What are the limits?” in Proc. IEEE Conf. Comput. Vis. Pattern Recognit. Workshops, Jun. 2012, pp. 21–26.
- [22] Y. Wang, P.-M. Jodoin, F. Porikli, J. Konrad, Y. Benezeth, and P. Ishwar, “CDnet 2014: An expanded change detection benchmark dataset,” in Proc. IEEE Conf. Comput. Vis. Pattern Recognit. Workshops, Jun. 2014, pp. 387–394.
- [23] Umakant Bhaskar Gohatre, Venkat P. Patil, “Performance analysis of Novel Technique for Video Based Real Time Object Detection in 2 Dimensional and 3 Dimensional Visual System” IJEECS, Volume 6, Issue 9, ISSN 2348-117X, September 2017.
- [24] Cheng, F.-C., Chen, B.-H., Huang, S.-C.: ‘A hybrid background subtraction method with background and foreground candidates detection’, ACM Trans. Intellig. Syst. Technol. (TIST), 2015, 7, (1), p. 7
- [25] Luo, Y., Guan, Y.P.: ‘Motion objects segmentation based on structural similarity background modelling’, IET Comput. Vision, 2015, 9, (4), pp. 476–488
- [26] Venkat P. Patil, Umakant Bhaskar Gohatre, R. B. Sonawane, “An Enhancing PSNR, Payload Capacity and Security of Image using Bits Difference Base on Most Significant Bit Techniques” International Journal of Advanced Electronics & Communication Systems, Approved by CSIR-NISCAIR ISSN NO: 2277-7318, Volume 6, Issue 02, March 2017.
- [27] Cheng, F.-C., Chen, B.-H., Huang, S.-C.: ‘A background model reinitialization method based on sudden luminance change detection’, Eng. Appl. Artif. Intell., 2015, 38, pp. 138–146
- [28] Zhao, Z., Zhang, X., Fang, Y.: ‘Stacked multilayer self-organizing map for background modeling’, IEEE Trans. Image Process., 2015, 24, (9), pp. 2841–2850
- [29] Chen, B.-H., Huang, S.-C.: ‘Probabilistic neural networks based moving vehicles extraction algorithm for intelligent traffic surveillance systems’, Inf. Sci., 2015, 299, pp. 283–295
- [30] Paul, M.: ‘Efficient video coding using optimal compression plane and background modeling’, IET Image Process., 2012, 6, (9), pp. 1311–1318
- [31] Faro, A., Giordano, D., Spampinato, C.: ‘Adaptive background modeling integrated with luminosity sensors and occlusion processing for reliable vehicle detection’, IEEE Trans. Intell. Transp. Syst., 2011, 12, (4), pp. 1398–1412
- [32] Huang, S.-C.: ‘An advanced motion detection algorithm with video quality analysis for video surveillance systems’, IEEE Trans. Circuits Syst. Video Technol., 2011, 21, (1), pp. 1–14
- [33] Do, B.-H., Huang, S.-C.: ‘Dynamic background modeling based on radial basis function neural networks for moving object detection’. 2011 IEEE Int. Conf. on Multimedia and Expo (ICME), 2011, pp. 1–4

National Conference on Current Trends in Engineering, Science and Technology (NACCTEST- 2018)
 Organized by GF's Godavari College of Engineering, Jalgaon
International Journal of Innovations in Engineering and Science, Special Conference Issue, 2018
 www.ijies.net

Solar Parameter Simulation

Supriya Baviskar¹, Annapurna Marathe², Pooja Desale³, Hemant T. Ingale⁴, Vijay. D. Chaudhari⁵, D. P. Marathe⁶

^{1,2,3} BE Students, Department of Electronics and Telecommunication
 GF's Godavari College of Engineering, Jalgaon, India, 425001

^{4,5,6} Assistant Professor, Department of Electronics and Telecommunication
 GF's Godavari College of Engineering, Jalgaon, India, 425001
⁴hetui@rediffmail.com

Abstract – The aim of this paper is to measure a solar panel parameters by using solar simulator. In this, a solar panel is used which keeps monitoring the sunlight. Here different parameters of the solar panel like light intensity, voltage, current and temperature are monitored. Solar panel is also known as photovoltaic cell device. The measured current and voltage (I-V) characteristics of photovoltaic (PV) device basically measured with respect to standard reference conditions, that is by a spectrum, intensity, temperature and area. This paper proposes a method of simulation of photovoltaic cell. The main objective is to find the I-V characteristics by adjusting the curve at points: open circuit, maximum power, short circuit, etc.

Keywords- Solar photovoltaic, solar cells, Solar simulator.

INTRODUCTION

A solar cell produces small power, in the range of less than a watt to few watts. However, for our application we need the power in ten of watts, kilowatts and sometimes megawatts. In order to generate large power using solar cell, many solar cells are connected together to make a PV module. The most common technology for solar PV modules uses crystalline Si solar cells. A photovoltaic system directly converts sunlight into electricity. The basic device of a PV system is the PV cell. Cells may be grouped to form panels or arrays. The voltage and current available at the terminals of a PV device. PV devices present a nonlinear I-V characteristic with several parameters that need to be adjusted from experimental data of practical devices.

Growing energy demand and soaring prices of fossil fuels along with concern about degrading. Environment have generated enormous amount of interest in the utilization of renewable energy sources. Power generation from photovoltaic has been a rapid growth in the last few years leading to extensive research on using solar energy.

The first purpose of this paper is to present a brief introduction to the behavior and functioning of a PV device. The introduction on PV devices is followed by the simulation of PV parameter, which is the main subject of this paper. A PV device may be any element that converts sunlight into electricity. The elementary PV device is the PV cell. A set of connected cells form a panel. Panels are generally composed of series cells in order to obtain large output voltages. Panels with large output currents are achieved by increasing the surface area of the cells or by connecting cells in parallel. A PV array may be either a panel or a set of panels connected in series or parallel to form large PV systems.

National Conference on Current Trends in Engineering, Science and Technology (NACCTEST- 2018)
 Organized by GF's Godavari College of Engineering, Jalgaon
International Journal of Innovations in Engineering and Science, Special Conference Issue, 2018
 www.ijies.net

METHODOLOGY

Here we guess the block diagram of general solar parameter simulator which we have to use to simulate the parameters. In this type of simulator we can simulate the parameters such as current, voltage, and also we can control temperature.

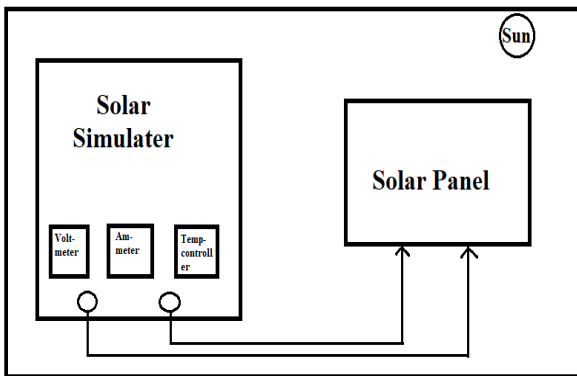

Fig. 1- Block Diagram of Solar Parameter Simulator

Block Diagram Description:

The above diagram is the block structure of solar parameter simulation. It contains the solar simulator which indicates the current, voltage and temperature controller at various condition. The input/output connection of the simulator is connected to the solar panel for measuring the I-V characteristics of solar panel.

Solar Panel:



Fig. Solar Panel

Solar panels absorb sunlight as a source of energy to generate electricity or heat.

A photovoltaic (PV) module is a packaged; connect assembly of typically 6x10 photovoltaic solar cells. Photovoltaic modules constitute the photovoltaic array of a photovoltaic system that generates and supplies solar electricity in commercial and residential applications. Each module is rated by its DC output power under standard test conditions (STC), and typically ranges from 100 to 365 Watts (W). The efficiency of a module determines the area of a module given the same rated output – an 8% efficient 230 W module will have twice the area of a 16% efficient 230 W module. There are a few commercially available solar modules that exceed efficiency of 22% and reportedly also exceeding 24%.

A single solar module can produce only a limited amount of power; most installations contain multiple modules. A photovoltaic system typically includes an array of photovoltaic modules, an inverter, a battery pack for storage, interconnection wiring, and optionally a solar tracking mechanism

Solar Simulator:

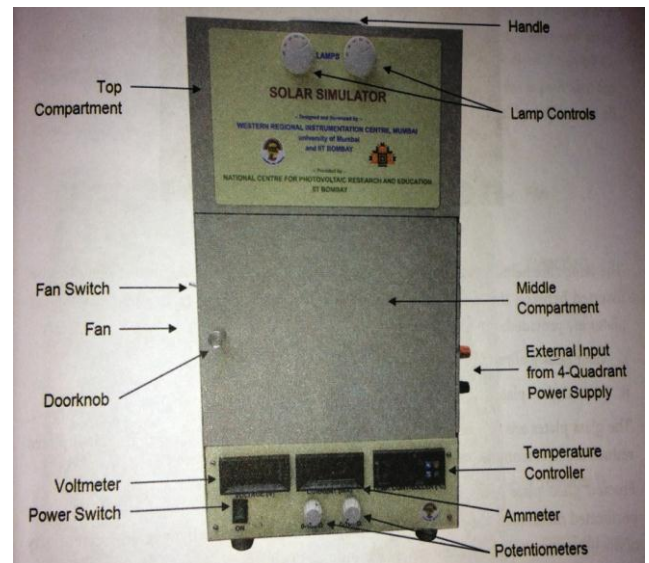

Fig. Solar Simulator

Solar simulator has two lamp control knobs in top panel. An ON/OFF power switch at the bottom

National Conference on Current Trends in Engineering, Science and Technology (NACCTEST- 2018)
Organized by GF's Godavari College of Engineering, Jalgaon
International Journal of Innovations in Engineering and Science, Special Conference Issue, 2018
www.ijies.net

panel, one 3-1/2 digit voltmeter (range 0-1.999 V), one 3-1/2 digit ammeter (range 0-1.999 A), one temperature controller (range room temperature to 80 degree C) and two potentiometers. In middle panel, there is one doorknob, which contain solar cells, exhaust fan and fan on and off switch. It also contain Input/ output knob.

Solar Parameters:

Short Circuit Current (I_{sc}):

The maximum current that a solar cell can deliver without harming its own constriction. It is measured by short circuiting the terminals of the cell at most optimized condition of the cell for producing maximum output. The term optimized condition is used because for fixed exposed cell surface the rate of production of current in a solar cell also depends upon the intensity of light and the angle at which the light falls on the cell. As the current production also depends upon the surface area of the cell exposed to light, it is better to express maximum current density instead maximum current. Maximum current density or short circuit current density rating is nothing but ration of maximum or short circuit current to exposed surface area of the cell.

Open Circuit Voltage (V_{oc}):

It is measured by measuring voltage across the terminals of the cell when no load is connected to the cell. This voltage depends upon the techniques of manufacturing and temperature but not fairly on the intensity of light and area of exposed surface. Normally open circuit voltage of solar cell nearly equal to 0.5 to 0.6 volt. It is normally denoted by V_{oc} .

Maximum Power Point:

The maximum electrical power one solar cell can deliver at its standard test condition. If we draw the V-I characteristics of a solar cell maximum power will occur at the bend point of the characteristic curve. It is shown in the V-I characteristics of solar cell by P_m .

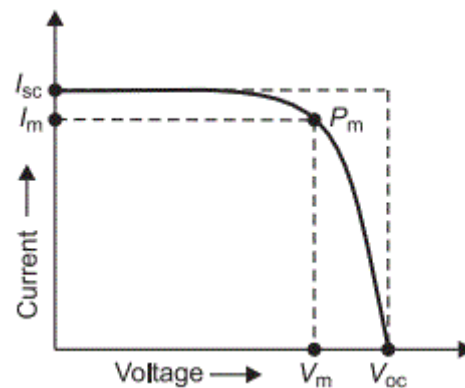

Current at Maximum Power Point (I_{mp})

The current at which maximum power occurs. Current at Maximum Power Point is shown in the V-I characteristics of solar cell by I_m .

Voltage at Maximum Power Point (V_{mp})

The voltage at which maximum power occurs. Voltage at Maximum Power Point is shown in the V-I characteristics of solar cell by V_m .

Fill Factor of Solar Cell (FF)

The ratio between product of current and voltage at maximum power point to the product of short circuit current and open circuit voltage of the solar cell.

Efficiency of Solar Cell

It is defined as the ratio of maximum electrical power output to the radiation power input to the cell and it is expressed in percentage. It is considered that the radiation power on the earth is about 1000 watt/square metre hence if the exposed surface area of the cell is A then total radiation power on the cell will be 1000 A watts.

National Conference on Current Trends in Engineering, Science and Technology (NACCTEST- 2018)
Organized by GF's Godavari College of Engineering, Jalgaon
International Journal of Innovations in Engineering and Science, Special Conference Issue, 2018
www.ijies.net

Ideality factor:

The ideality factor is a linear function of cell temperature (K). Ideality factor is obtained from the dark I-V characteristics.

Reverse saturation current:

The reverse saturation current depends upon the temperature and on the material band gap energy and number of cell in series.

Light current:

Light current parameter depends on the effective solar irradiance, the cell temperature, the short circuit current temperature coefficient, and the air mass modifier, among other parameters.

Series resistance:

The series resistance parameter depends on the effective solar irradiance and cell temperature.

Shunt resistance:

The shunt resistance parameter controls the slope of the I-V curve at the short circuit conditions.

Methodology for measurement

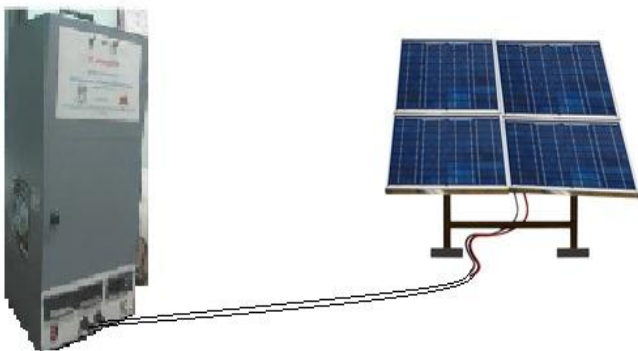

Fig: solar parameter simulation

In this we have to measure a parameters in different conditions like solar panel in certain angle, as

well as tracking and non-tracking also cleaning and non-cleaning of solar panel.

Tracking and non-tracking:

The solar panel is situated in different angles as we have to measure parameters in different conditions. The angle should be less than 90° , 90° or greater than 90° . Normally PV modules are installed at an angle equal to the latitude angle of the location. In this position, the amount of life intercepted by PV modules is less compared to the case when solar PV modules are placed perpendicular to the sunlight. Due to this there is gain in energy generation when the PV modules are placed perpendicular to the sunlight. The purpose of the experiment is to study the difference in energy generation when PV module is fixed at an angle and when PV module is tracking the sun.

Shading:

The solar parameters are discussed with respect to shading due to soiling. Shading due to soiling is divided into two categories namely soft shading such as air pollution and hard shading which occurs when a solid such as accumulated dust blocks the sunlight.

There are many external influence that can make panel dirty, including dust and road grime, salt spray and bird dropping to name a few. A photovoltaic system performed a best with the completely unobstructed access to the sun rays for the most or all for the day. It seems to be inconsequential as a residue layer can affect the performance of your panel. In rainy, it was generally accepted that the rain would clean the panels. We at lime solar cleaning recommended that panels can be cleaned

Series and Parallel Connection:

The series connection of PV modules is similar to the series connection of solar cell in a PV module. The voltage of PV module gets added. Note that in making series connection of PV modules, it is not only the PV module voltage that increase but also the total power generator also increases.

In parallel connection of PV modules, the voltage of the combination remains the same as that of

National Conference on Current Trends in Engineering, Science and Technology (NACCTEST- 2018)
Organized by GF's Godavari College of Engineering, Jalgaon
International Journal of Innovations in Engineering and Science, Special Conference Issue, 2018
www.ijies.net

the individual modules whereas the current of the parallel combination is a sum of the currents of all PV modules.

CONCLUSION

In this paper we tried to measure parameters of solar panels such as voltage, current, and temperature. Digital display can be used to display values of these parameters by using solar simulator at various conditions like solar tracking and non-tracking, cleaning and non-cleaning, and series and parallel connection of the solar cells. There are many ways to measure the solar parameters. But, in this proposed work we can easily understand the comparatively study of solar parameters at various conditions.

REFERENCES

- [1] Keith McIntosh, Pietro P. Altermatt, Gaby Jannsen, Rolf Arnold Stangl, "Input Parameters for the Simulation of Solar Cells", July 2014.
- [2] Adil Sarwar, Mashhood Hasan, A. Q. Ansari, "Five Parameter Modelling and Simulation of Solar", 978-1-4673-7492-7/15/\$31.00@2015 IEEE.
- [3] Md.Nazmul Islam Sarkar, "Effect of Various Model Parameters on Solar Photovoltaic Cell Simulation: a SPICE analysis, 2016.
- [4] Lijun Gao, Roger A. Dougal, Shengyi Liu, Albern P. Lotova, "Parallel-Connected Solar PV System to Address Partial and Rapidly Fluctuating Shadow Conditions, 5/9/2009.
- [5] Marcelo Gradella Villalva, Jonas Rafael Gazoli, and Ernesto Ruppert Filho, "Comprehensive Approach to Modelling and Simulation of Photovoltaic Arrays, 5 may 2009.
- [6] J. A. Gow, C. D. Manning, "Development of a Photovoltaic Array Model for use in Power-Electronics Simulation Studies", 2 March 1999
- [7] Sumedh V. Dhole, Saurav Kumar, Anmol Grover, Vikas P. Kaduskar, Jitendra Kumar, "Review of Solar Energy Measurement System", Jan 2017
- [8] Abhishek Kumar, Abhinav Kumar Dwivedi, "Solar Power Parameter Calculator", May 2013

National Conference on Current Trends in Engineering, Science and Technology (NACCTEST- 2018)
Organized by GF's Godavari College of Engineering, Jalgaon
International Journal of Innovations in Engineering and Science, Special Conference Issue, 2018
www.ijies.net

ELECTROMAGNETIC INTERFERENCE IMPROVEMENT IN ELECTRONIC CIRCUITS

Rahul R. Deore¹, Yashwant A. Mahajan², Syd Juned Ali³, Vijay D. Chaudhari⁴, Dr. S. B. Deosarkar⁵, D. P. Marathe⁶

^{1,2,3,4,6} Students, ^{4,6} Assistant prof, ⁵ Professor

^{1,2,3,4,6} department of Electronics and Telecommunication, GF's Godavari College of Engineering, Jalgaon, India

⁵ Professor, Department of E&TC Engg, Dr. Babasaheb Ambedkar Tech University, Lonere, Raigad, M.S. India

⁴vinuda_chaudhari@yahoo.co.in

Abstract – EMI caused by generation & radiation of unwanted RF signals that pollute carefully managed radio spectrum. Increasing data-rates and tougher EMC standards make EM radiation a highlighted concern. Recent digital ICs like microprocessor and DSPs include an increasing number of elementary logic gates which absorb/drive pulsed currents driving EM emissions. EM field directly radiated by package frame and circuit routed at silicon level are referred as IC radiated emissions. The pulsed currents conducted off chip by the IC pins feeding PCBs traces and cables which act as emitting antennas are referred as IC conducted emissions. An attempt has been made here to review the problems associated with interference issues results in RF disruption or intermittent failure of electronic, communication and information system. The signal with sharper rising/falling edge is comprised of higher order Harmonics. The Harmonics-included in actual digital signal are the principle cause of EMI emission from electronic simulator simulates noise suppression filters and chip capacitors in single end line and differential line. EMC means that the device is capable with its EM environment & does not emit the EM energy that can cause EMI in other IT, industrial & healthcare devices in the vicinity

Keywords: EMIFIL, BLM-NFM series filters, EMC standards, Conducted Emission

INTRODUCTION

1.1 EMI Fundamentals:

Electromagnetic Interference: An EM disturbance which may degrade the performance of a device, system / sub-system or an equipment or causes unwanted response / malfunction of an electronic or

electrical equipment. [5] Radio Frequency (RF): The frequency range in which coherent EM radiation is useful for communication purposes - roughly from 10KHz to 100GHz. This energy may be generated internationally, as by a radio transmitter or unit nationally as by electronic devices operation. RF energy is transmitted through two basic modes: Radiated Emission (RE): The component of RF energy that is transmitted through a medium as an EM field. RF energy is usually transmitted through free space. Conducted Emission (CE): The component of RF energy that transmitted through conductive medium as an EM field, generally through a wire or interconnect cables referred to be CE. Line conducted interference (LCI) refers to RF energy in a power cord.[3]

Electromagnetic Compatibility

EMC is a near perfect state in which a receptor (a device, or equipment, or a system/sub-system) functions satisfactorily in common EM environment, without introducing intolerable EM disturbance to any other devices/ equipment / system in that environment. An Electromagnetic disturbance which may degrade the performance of a device, system / sub-system or an equipment or causes unwanted response/malfunction of an electronic or electrical equipment or IT equipment. EMI noise problems [8] since the design have many ICs which make the process of EMI emission very complicated [9]

National Conference on Current Trends in Engineering, Science and Technology (NACCTEST- 2018)
 Organized by GF's Godavari College of Engineering, Jalgaon
International Journal of Innovations in Engineering and Science, Special Conference Issue, 2018
 www.ijies.net

energy is usually transmitted through free space.

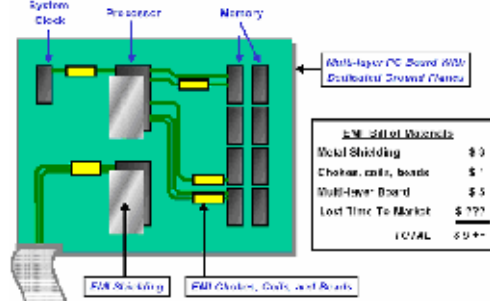

Fig.1 Conventional technique reduces EMI

EM Compatibility is a near perfect state in which a receptor (a device or equipment or a system/sub-system) functions satisfactorily in common EM environment, without introducing intolerable EM disturbance to any other devices equipment system in that environment. The effects of noise and interference are different at different segments, or frequencies of the EM spectrum.

LITERATURE SURVEY

The simultaneous switching noise simulation and the comparison of those simulations to laboratory measurements of noise on a specially designed CMOS test chip on a multilayer ceramic SCM are presented[1]. The reduction of conducted emission for UPS using commercial and modified passive filter is implemented. The experiment has been done at two types of UPSs: true on-line and off-line. The comparison of Merent mode operations of UPS shows a closed agreement of conducted emission. Measured conducted mission results support that the EMI passive filters can reduce the conducted emission level to achieve the limit. Polystyrene capacitors have been tested and shown some satisfactory result. However, it is warning that it can Bethe weak point of safety concerning the leakage current. Awareness of the significance of EMC is then essential in the field of design, development, production, and maintenance for UPSs.[2]Radiated Emission (RE): The component of RF energy that is transmitted through a medium as an EM field. RF energy is usually transmitted through free space. Conducted Emission (CE): The component of RF energy that transmitted through conductive medium as an EM field, generally through a wire or interconnect cables referred to be CE. Line conducted interference (LCI) refers to RF energy in a power card.[3]

The chip EMIFIL incorporates a built-in three terminal capacitor, eliminating the lead w Chip ferrite beads are effective for frequencies ranging from a few MHz to few GHz and are widely used as a low noise countermeasure, as well as a universal noise suppression component.[4] An EM disturbance which may degrade the performance of a device, system / sub-system or an equipment or causes unwanted response / malfunction of an electronic or electrical equipment.[5] Should the take help of EMI/EMC experts in controlling EMI problems at the early stages to save the time and cost of the system. Selection of proper EMI components/devices and mounting of these components on PCB is also very important in reducing the EMI problems. [6] CE may cause Radiated Emissions (RE), which may cause interference. The reduction of these CE is simpler than the **reduction** of RE. **So**, it is important to realize that if a product fails to comply with the limits on CE, there is no point of complying with the limit of RE. Therefore, controlling CE of the product is the first priority compared with the control of RE. The knowledge about EMI Filters to mitigate CE is an advantage for product to comply the market. Meanwhile, the CE can be divided into two types, which are CM and DM. EMI Filters are designed on the basis of a personal designers experience and by trial and error with the objective of maximum loss of interference. [7].

An Electromagnetic disturbance which may degrade the performance of a device, system / sub-system or an equipment or causes unwanted response/malfunction of an electronic or electrical equipment or IT equipment. EMI noise problems[8], since the design have many ICs which make the process of EMI emission very complicated energy is usually transmitted through free space. Capacitive noise suppression: When a capacitor is connected (bypass capacitor) to ground from a noisy signal line or power line, the circuit impedance decreases as the frequency increases [9]. Since the noise is high frequency phenomenon and it flows to ground thereby making it possible to eliminate noise & harmonics. [10]

METHODOLOGY

1. Some EMI measuring setups available

1.1 CE measurement setup

National Conference on Current Trends in Engineering, Science and Technology (NACCTEST- 2018)
 Organized by GF's Godavari College of Engineering, Jalgaon
International Journal of Innovations in Engineering and Science, Special Conference Issue, 2018
 www.ijies.net

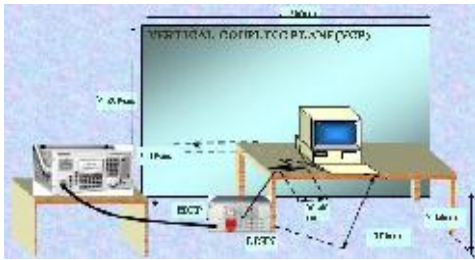

Fig. 2 CE testing as per CISPER 11

1.2 Radiated EMI measurement setup

1.2.1 Anechoic chamber

1.3 CISPER 11 (International Special Committee on Radio Interference) EMC standard

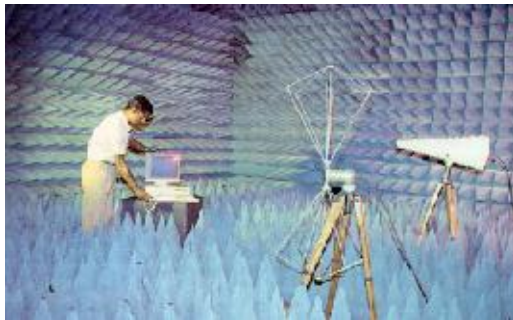

Fig. 3 Radiated Emission testing as per CISPER 11.

2 EMI Suppression Filters

2.1 On-board EMI suppression filters (chip EMIFIL):

Chip ferrite beads are effective for frequencies ranging from a few MHz to few GHz and are widely used as a low noise countermeasure, as well as a universal noise suppression component. At high frequencies, however, the resistive component of the inductor produces the primary impedance. When inserted in series in the noise producing circuit, the resistive impedance of the inductor prevents noise propagation. The chip EMIFIL [4] incorporates a built-in three terminal capacitor, eliminating the lead wire. Chip ferrite beads are effective for frequencies ranging from a few MHz to few GHz and are widely used as a low noise countermeasure, as well as a universal noise suppression component. At high frequencies, however, the resistive component of the inductor produces the primary impedance. When inserted in series in the noise producing circuit, the resistive impedance of the inductor prevents noise propagation. The chip EMIFIL [4] incorporates a built-

in three terminal capacitor, eliminating the lead wire and thereby increasing the high frequency performance characteristic.

Table 1: Standard Emission Levels

Frequency of Emission (MHz)	FCC CLASS A (microvolts/meter)/(dBuV/m)	CISPR 22 CLASS A CISPR 32 CLASS A (microvolts per meter)/(dBuV/m)
30-88	90/39	100/40
88-216	150/43.5	100/40
216-230	210/46.5	100/40
230-960	210-46.5	224/47
Above 960	300/49.5	224/47

Table 2: Standard Emission Levels

Frequency Range	Class A Limits		Class B Limits	
	FCC ^{Note 1}	CISPR	FCC	CISPR
1-3GHz	Avg 60dBuV/m Pk 80dBuV/m	Avg 56dBuV/m Pk 76dBuV/m	Avg 54dBuV/m Pk 74dBuV/m	Avg 50dBuV/m Pk 70dBuV/m
3-6GHz	Avg 60dBuV/m Pk 80dBuV/m	Avg 60dBuV/m Pk 80dBuV/m	Avg 54dBuV/m Pk 74dBuV/m	Avg 54dBuV/m Pk 74dBuV/m
6-40 GHz	Avg 60dBuV/m Pk 80dBuV/m	No requirement	Avg 54dBuV/m Pk 74dBuV/m	No requirement ^{Note 3}

Chip ferrite beads produce a micro inductance in the low frequency range. The use of ferrite beads on input and output terminals minimizes resonance with surrounding circuits. The three terminal constructions reduce residual inductance, thereby substantially improving noise suppression at frequencies over 10 MHz.



Fig. 4 Chip ferrite Beads EMI filter

Simulation with CMOS IC 74HC04

4.1 Spread spectrum technique:

Spreading the spectrum of a frequency means distributing the energy that was originally concentrated at one frequencies (or more accurately over a narrow band of frequencies) over a wider band, thereby

National Conference on Current Trends in Engineering, Science and Technology (NACCTEST- 2018)
 Organized by GF's Godavari College of Engineering, Jalgaon
International Journal of Innovations in Engineering and Science, Special Conference Issue, 2018
 www.ijies.net

reducing peak emissions. Just the bandwidth requirement will be more. The energy is distributed by modulating the signal slowly between two frequency boundaries. The method of modulation dramatically influences the amount of EMI reduction. The IC is then configured appropriately (setting deviation, modulation rate, load and profile) within EMI-Lator environment. The system is then simulated with appropriate system parameters (setting trace & environment parameters). The software takes into account spread spectrum parameters as well as system parameters such as trace length, loads & signal strengths.

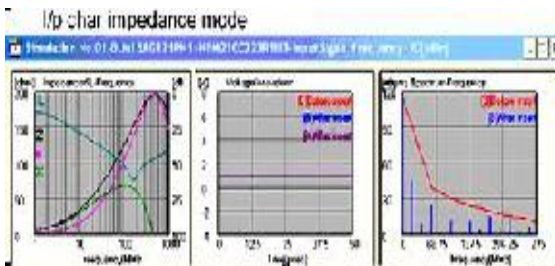
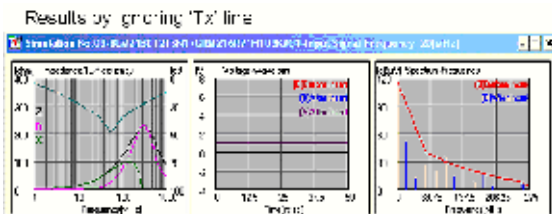

Fig. 5 Simulation results



5.2 Simulation with TTL IC 74LS04

Input Signal parameter & configuration parameter are selected as

Freq. 20MHz (Fix for all simulations)

Duty Cycle 50%

Rise Time 1.7nsec

Fall Time 1.7nsec

I/P Voltage 5v

I/P Characteristic Impedance 169.74ohm

Width of line 0.5mm

Thickness of PCB 1.4mm

Length of line 100mm

Material of PCB (Die lectric Const.) k=4.6

(Epoxy glass)

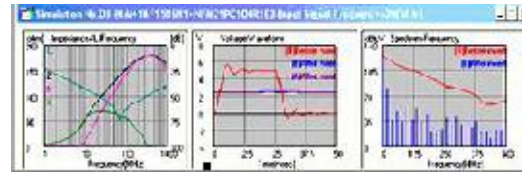

Fig. 6 Simulation results

Simulation With CMOS 74HC04

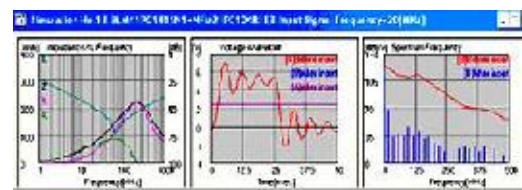
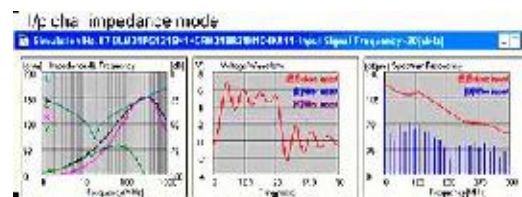

Fig. 7 Simulation results

As we increased the capacitance value it is found that the impacts on the output voltage amplitude and also found that the drastic decrease in output voltage up to 1V after the insertion of EMI suppression filter obtained in the results is the effect of the same. At high frequencies, however, the resistive component of the inductor seems to produce the primary impedance. When inserted in series in the noise producing circuit, the resistive impedance of the inductor prevents noise propagation. Capacitive noise suppression: When a capacitor is connected (bypass capacitor) to ground from a noisy signal line or power line, the circuit impedance decreases as the frequency increases. Since the noise is high frequency phenomenon and it flows to ground thereby making it possible to eliminate noise & harmonics [10]. HF capacitor: General purpose capacitor may not function as effective bypass capacitor due to large residual inductance built in it. Murata's three terminal structure or through type structure functions effectively even at HF (>1GHz) thereby minimizing influence of residual inductance. Inductive noise suppression: When L is inserted in series in a noise producing circuit, its impedance increases

National Conference on Current Trends in Engineering, Science and Technology (NACCTEST- 2018)
 Organized by GF's Godavari College of Engineering, Jalgaon
International Journal of Innovations in Engineering and Science, Special Conference Issue, 2018
 www.ijies.net

with frequency which attenuate and eliminates HF noise component.

Since the objective of this paper is to mitigate CE & harmonics we have chosen BLM filters to use with chip EMIFIL such as NFM, NFL type EMI suppression filters. This gives more effective result in reducing CE and Harmonics. The insertion loss on which the EMI filter circuit selection is depends, here it is possible to maintain in the range of 55-75dB for frequency 50MHz-200MHz which proves very effective in reducing EMI emissions. The approximate results obtained are at 1 MHz with insertion loss of 25dB, and at frequency of 70MHz IL is about 75dB while at 1000MHz it is upto 40dB.

CONCLUSION

Concentrating on numerical modeling and proper Layout designing we can reach to more effective and close results to the simulated once. Filtering approach to mitigate EMI will be the last resort after modeling and proper layout of EUT and provide effective EMI compliance.

REFERENCE

- [1] *A Model to Hardware Comparison of Simultaneous Switching Noise on a CMOS Chip: Published By B. McCredie, S. Kuppinger, G. Katopis, and W. D. Becker 1994*
- [2] *Reduction of Conducted Emission for UPSs using Passive EMI Filters: Publish By Werachet Khan-ngern , Yothin Prempaneerach 1998*
- [3] *Wakileh, George J., "Power System Harmonics: Fundamentals, analysis and filter design", Berlin: Springer, 2001.*
- [4] *"Noise Suppression by EMIFIL-Digital Equipment", Murata Application Manual*
- [5] *V.Prasad & Kodali, "Engineering Electromagnetic Compatibility–principles, measurements & techniques", IEEE press.*
- [6] *electromagnetic interference (emi) suppression techniques - a case study : Publish By Devender, K.Nageswara Rao, K.Suryanarayana, Shanta Sarvade, D.Ramesh 2002*
- [7] *Analysis And Design Of EMI Filters To Mitigate Conducted Emissions: Publish By Handy Ali Munir, Mohd Zarar Mohd Jenu and Mohamad Faiz Liew Abdullah 2004*
- [8] *Henry W. Ott., "Noise reduction technique in electronic system", 2nd edition – Wiley interscience*
- [9] *Stephen Hall, Garret Hall, James Mcall, "High speed digital system design – a handbook on Interconnect theory and design practices"- Wiley Inter science.*
- [10] *A. F. Zobba, "A new approach for voltage Harmonic Distortion minimization",*

National Conference on Current Trends in Engineering, Science and Technology (NACCTEST-2018)

Organized by GF's Godavari College of Engineering, Jalgaon
International Journal of Innovations in Engineering and Science, Special Conference Issue, 2018
 www.ijies.net

REVIEW PAPER ON DETECTION OF DISEASES OF EYES USING SOFT COMPUTING TECHNIQUE

Bansode Balbhim Narhari¹, Dr. Ajj Sayyad², Dr. Bakwad K. M.³, Dr. CH. Vidyasagar⁴

¹ Research Scholar, Amrutvahini College of Engineering, Sangamner, Maharashtra, India

² Professor & Head, E&TC Engg, MIT Aurangabad, Maharashtra, India

³ Professor & Head, Electronics Enggdept, P. L. Govt. Poly, Latur

⁴ Professor & Head, E&TC Engg dept, Govt. Poly, Narayankhed, Telangana

¹balbhimbansode231@gmail.com, ³bakwad_km@rediffmail.com

Abstract:- Human retina is one of the wellsprings of biometric system which gives the most dependable and effective method for confirmation. SVM classifier and has been combined with the feature extraction method to enhance the efficiency of medical image retrieval system. The two cost effective algorithms are planned for exudates recognition and optic disc removal aimed for retinal images arrangement and diagnosis support. Cost effective algorithm is used for optic disc identification. Fundus images are classified into those that are strong and those affected by diabetes, based on the detection of optic disc and exudates. Artificial Neural Networks (ANN) gives reliable diagnosis and takes less time than the reading center model. To convert objectively measurable parameters to "category memberships fuzzy logic is used. Artificial Neural Network (ANN) and Support Vector machine are used to separate the various images based on features.

Machine (SVM) .Optical Coherence Tomography (OCT) is used to detect present of cysts. The transmission for recognition of such deviations in the retina is called Diabetic Retinopathy (DR). By using various features extraction methods and classifiers

we can detect the diseases and increase the identification rate.

Keywords – Diabetic macular edema (DME) Cup Disc ratio (CDR), micro aneurysm, blood vessels, exudates, retinal image, diabetic retinopathy, Support Vector Machine Classifier.

INTRODUCTION

Introduction: Swelling in the macular region of retina which is also known as macular edema, is a difficulty of the eye often foremost to reduced capacity of vision. Diabetic macular edema (DME) caused due to diabetes is a high risk obstacle which can cause irreversible loss of vision [1]–[3]. Early detection of even a minor sign of DME is critical as it may also appear without any external indications [4]. According to current status Diabetes is the third leading cause of expiry after cancer and heart diseases. The serious obstacles of uncontrolled diabetes include kidney damage, eye damage, nerve disease and stroke. Diabetic retinopathy (DR) is a common retinal problem related with diabetes. The Diabetic Retinopathy finds the exudates parts in the eye by applying Neuro Fuzzy based on feature extraction. Diabetic retinopathy is an eye disease that is noticed in patients with extensive time diabetes.

National Conference on Current Trends in Engineering, Science and Technology (NACCTEST-2018)

Organized by GF's Godavari College of Engineering, Jalgaon

International Journal of Innovations in Engineering and Science, Special Conference Issue, 2018

www.ijies.net

Diabetic retinopathy indications the swelling of the retina leaks or irregular growth of blood vessels, resulting in severe vision loss or blindness. The presence of micro aneurysms (MAs) is usually an early sign of diabetic retinopathy and their spontaneous detection from shade retinal images is of clinical attention. DIABETIC retinopathy (DR) is a major community health matter since it can lead to impaired vision in patients with diabetes. Microaneurysms (MAs) is usually the first clinical indication of DR. They are swellings of capillaries caused by a failing of the vessel wall [2]. Their sizes range from 10 to 125 μm [5]. Diabetic Retinopathy is a dangerous eye disease and the most common cause of vision loss for worldwide people. Digital shade fundus images are suitable for diagnosing Diabetic Retinopathy. Diabetes mellitus (DM) has been identified as one of the noticeable causes of death, disability, and blindness in the world. According to World Health Organization (WHO) statistics, more than 285 million people around the world have DM and it is predicted to reach 439 million people by 2030 [6]. Diabetic retinopathy (DR) is the greatest common eye disease that affects patients with DM.

Significance Of Anatomical Structure Detection:

The optic disc is a circular to oval white area computing about 2 x 1.5 mm across in dimensions. The major blood containers of the retina are exuded from the center of the optic disc. Another important structure is the slightly oval-shaped, blood container-free reddish spot, the fovea, which is at the center of the area known as the macula by ophthalmologists. The total retina is a circular disc of between 30 and 4 mm in diameter. The statistics of blood containers, such as length, width, tortuosity and separating pattern, can not only provide information on pathological changes but can also help to grade diseases strictness or automatically diagnose the diseases. Optic disc parameters such as span can allow detection of other retina structures such as the

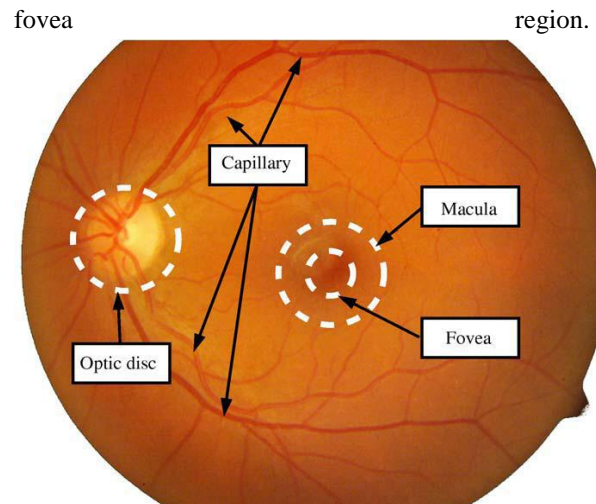

Fig.1. Sample retinal image with anatomical structures

LITERATURE REVIEW

Literature review:- Many important eye diseases as well as systematic diseases visible themselves in the retina. The main reason of blindness in people with diabetes is Diabetic Macula Edema (DME) which is common in type 2 diabetes. Diabetic Retinopathy is a obstacle caused by diabetes mellitus and the second most joint cause of blindness and visual loss in the US. The exudates in the DR are caused by buildup of proteins and lipids from blood leaking into the retina complete damage blood vessels. They seem as bright, reflective, heavy white/cream highlighted areas on the ophthalmoscope. There are number of approaches reported on the subject area to identify the hard exudates. An automated analysis of fundus image is very essential and will aid to assist clinical identification. The various diseases that will affect eye are found out with the help digital fundus image. The primary principle for the detection of intraregional fatty (hard) exudates, that are not objective a principle sign of DR, but likewise an warning of the natural event of co-existent retinal edema and if present in the fissionable area, exudates are major players of vision loss in diabetic retinopathy.[24]

National Conference on Current Trends in Engineering, Science and Technology (NACCTEST-2018)

Organized by GF's Godavari College of Engineering, Jalgaon

International Journal of Innovations in Engineering and Science, Special Conference Issue, 2018

www.ijies.net

1. Cup Disc Ratio:

Then optic cup and disk are removed as shown in figure 2. Once the optic cup and optic disc are removed, and then comes the measurements of the Cup Disc ratio (CDR). It is calculated as shown in Fig 2. Typical optical cup region and optical disk region is shown in fig 3. Once the cup and disc boundaries are found, we will follow clinical method of detecting Cup-Disc Ratio which is an indicator for the exposure of the presence of glaucoma disease in the patient.

$CDR = \text{Area of the Cup} / \text{Area of the Disc}$

When the cup-disc ratio rises over a threshold value, we consider that the patient is distress from glaucoma or we can say that the patient is glaucomatous.



Fig.2 Measurement of Cup to disc ratio

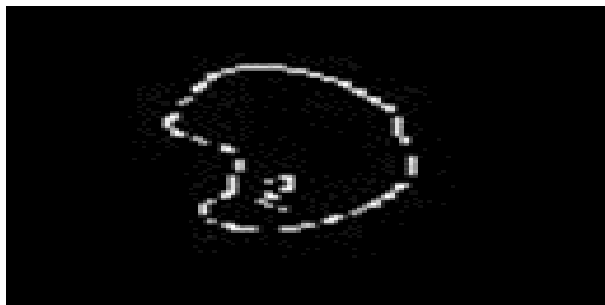

Fig.3. Extraction of optic disk and optic cup

2.Surf Descriptor And Pattern Recognition Techniques In Automatic Identification Of Pathological Retinas (2015) Rodrigo Veras,

Romuere Silva, Flávio Araújo, Fátima Medeiros[26] applied the Speed Up Robust Feature ,developed algorithm that finds points of notice to form visual wordlists. To assemble these interest points k-means clustering algorithm is used. To determine whether an image is healthy or consists any type of symptoms of disease this paper uses multiple classifiers.

Advantages

1. Able to detect characteristic points of each image .
2. The method proposed is robust.
3. The accuracy rate was 97.25

Disadvantages

1. Poor performance as the algorithm is not able to detect small artifacts.
2. There is loss of information during the creation of the visual dictionary.

3.Feature extraction from the fundus images for the diagnosis of Diabetic Retinopathy (2016):To assist early stage of a Diabetic Retinopathy detection of injuries in a fundus image is necessary. This paper uses MAHM algorithm. ManojKumar S B, Manjunath R, Dr. H S Sheshadri [27] proposes new parameter for optic disk detection which detects the major containers and future use the connection of these to find the estimate the region for optic disk. In the further step this region is localized by applying shade properties. This system uses color fundus images as input.

Advantages

1. Provides an efficient framework for Diabetic Retinopathy.
2. Various features such as hemorrhages, micro aneurysms, hard exudates and soft exudates can be detected.

Disadvantages

1. Can only detect Diabetic Retinopathy.

4.Features extraction methods

Various techniques have been adopted for eye detection which includes wavelets, principal

National Conference on Current Trends in Engineering, Science and Technology (NACCTEST-2018)

Organized by GF's Godavari College of Engineering, Jalgaon

International Journal of Innovations in Engineering and Science, Special Conference Issue, 2018

www.ijies.net

component analysis, fuzzy logic, evolutionary calculation and hidden markov models and template matching. Huang and Wechsler [29], used optimal wavelet packets for eye symbol and radial basis functions for sorting of eye and non-eye regions. Talmi, *et al.*, and Pentland, *et al.*, [30, 28] made use of very few appearances of human eyes in Principal Component Analysis for eye detection. Torii, A. and Imiya A [31], used Karhunen-Loeve-Transformation to represent the major features of human eyes and are stored as location patterns for the localization of human eyes in video images.

Devisaranya *et al.*, (2015) proposed a system which is used for identifying Micro aneurysms, which can be known by automatically analyzing the retinal image. Initially the blood containers are removed from the fundus image and classification of blood containers such as blood vessel and veins should be made for determining the container parameters. The Graph trace algorithm is used for the sorting of retinal blood vessels. It also computes parameters of the vessels such as length, caliber measurement and diameters of the container. Diseases can be identified by comparing these parameters with the normal value. If there is any deviance it will indicate the presence of certain diseases. This automatic retinal image analysis decreases the effort and burden of ophthalmologist by providing ophthalmologists.

5. In eye tumour detection system (ETDS): Image processing techniques have been applied in order to increase the eye tumour images. Initially, the original image has been transformed to gray scale in order to reduce the CPU time, followed by image filtering in order to eliminate excess data within the image. Afterwards, image enhancement technique is applied to prepare handled image for image subtraction. Canny edge finding has been applied in segmentation step for image fusion.

6. Image Filtering

Pressing, which is also known as blurring, is an image processing technique that decreases the noise

in an image to create significant image for future step. Most pressing techniques are based on low pass linear filters. In order to perform a pressing operation, a filter is applied to an image. The most common type of filters is the linear filters. Median filter is a type of linear filters [32].

Median filter is used to decrease impulsive noise in an image with maintaining the useful features and image edges. Median filtering is a linear process in which the output of the being handled pixel is found by calculating the median of a window of pixels that surrounds the studied pixel[33].

7. Iris Tumor Detection System (ITDS)

The system is implemented using Matlab programming language (Matlab 2013 software tools). ITDS is based on different image processing techniques used in order to inspire the human visual examination for sensing the iris tumor into an eye. The eye images (fig. 4 & 5) are obtained from "Miles research" [34]; a public database available on the internet. The images are converted first to gray scale images, and then these images are filtered using median filter in order to enhance their quality. The background image is removed in order to be then deducted from the original one. Image adjustment is applied to the resulted image, thus raises its pixels intensity which clears that the area is then segmented in the next step, the edge finding using canny operator.

The last method is to cover the extracted ROI on the original gray scale image using image mixture in order to mark the tumor region onto the original image

National Conference on Current Trends in Engineering, Science and Technology (NACCTEST-2018)

Organized by GF's Godavari College of Engineering, Jalgaon

International Journal of Innovations in Engineering and Science, Special Conference Issue, 2018

www.ijies.net



Fig.5. Normal eye



Fig.4. Eye with an iris tumor

8. Grayscale conversion

The first step is to translate the RGB image to gray scale. This translation is done using the luminosity method which relies on the influence of each color of the three RGB colors. Using this method, the gray scale image is brighter since the colors are weighted according to their contribution in the RGB image not averagely [35]



Fig.a

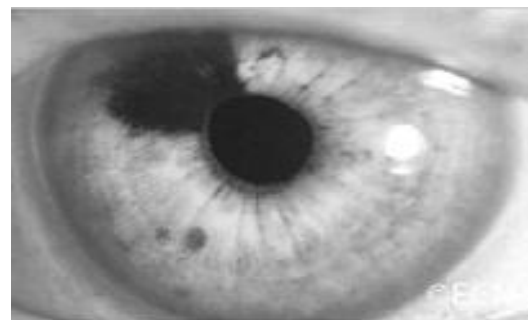

Fig.b

Fig.6. RGB image of an eye with iris tumor, (b) Gray scale converted image of (a).

9. Image Addition

This technique results in a brighter image. Image addition is used to design system to clear and enhance the tumour area by buildup more pixels to image in the designed system. This technique is to add the removed background image to the original image which results in a brighter and enhanced image.

10. Image Adjustment

Image adjustment is growing the image intensity and its quality. This image handling technique intends to increase the quality and brilliance of the image by growing the intensity of its pixels. This is done by changing the difference or brightness of an image. In this procedure, pixel values below a definite value are displayed as black and pixel values beyond a specified value are shown as white, and pixel values in between these two values are showed as shades of

National Conference on Current Trends in Engineering, Science and Technology (NACCTEST-2018)

Organized by GF's Godavari College of Engineering, Jalgaon

International Journal of Innovations in Engineering and Science, Special Conference Issue, 2018

www.ijies.net

grey. The result is a linear mapping of a subset of pixel values to the complete range of greys, from black to white, creating an image of higher contrast [36]



Fig.7. a. addition



Fig.7.b. Image adjustment

Features extraction methods

i)Candidate Region Extraction (Feature Extraction): Candidate region (lesion) is a small round object which is look like dark red dot and patches in retinal image. We can see them with our naked eye it can be able to classify but they varies based on its texture, divergence and blood containers in the image makes difficult to find its clearly. The phases are extracted by Gabor filter and blood containers are segmented to extract it without any trouble [7]. The Gabor filters are one of the robust and accurate way to identify vessel pattern and its withdrawal make the entire procedure is easier. The dissimilarity enhanced image is given for Gabor filter banks for improvement of lesions. Gabor filters are Well-known due to their fine frequency alteration and

orientations electiveness. They are appropriate for texture representation and discrimination [8]. Gabor filter is characterized by a Gaussian kernel function which can model a wide range of shapes depending upon the values of its parameters [7].

2. Pre-Processing Medical images may suffer from poor dissimilarity and noise during image achievement with respect to scanning devices and illumination etc. Dissimilarity enhancement can be attained by using histogram equalization technique. A 3x3 Median filter will be adapted for noise elimination from the medical images.

3. Image processing

Image processing techniques change the gray values of the pixels. There are three fundamental systems by which this is ended. In its most basic way, the pixel gray values are reformed with no processing of around or "neighborhood" pixel values. Neighborhood processing consolidates the estimations of pixels in a small neighborhood about every pixel being referred to. At last, changes are more complex and include control of the whole image so that the pixels qualities are understood in an alternate yet proportional form. This may take into account more creative and capable processing before the picture is frequent to its unique method of representation.[18]

4. Image enhancement

A effort in the captured image of the ocular fundus is picture quality which is unfair by many factors, for example, media opacities, defocus or vicinity of relic [11,12]. Picture enhancement includes the enlargement or improvement of images so that the result is more appropriate for further operations. Image development means the image is more satisfactory for analysis, treating or viewing. This may include procedures, for example, improving complexity or brighten up an image. The picture histogram gives important data about the presence of

National Conference on Current Trends in Engineering, Science and Technology (NACCTEST-2018)

Organized by GF's Godavari College of Engineering, Jalgaon

International Journal of Innovations in Engineering and Science, Special Conference Issue, 2018

www.ijies.net

an image. It comprises of a graph signifying the quantity of times every gray level happens in the image. Horizontal line of the graph shows the possible gray level existing in the images, e.g., 0–255. The vertical line of the graph specifies number of occurrence of those gray level pixels. In an unreasonably dull or brightest image, the gray level would be bunched to the limits of the histogram,[19][20]

5. Edge detection

Edge Detection is one of the most commonly used image handling techniques for detecting edges in a very robust manner. Canny edge detection is a procedure to identify and locate sharp in images. To work exactly it has to follow the algorithm steps which are very important to find out limits and should not miss the edge from the images. Secondly, edge points will be limited well means distance between actual edge and edge pixels as found by the detector should be minimum. Thirdly single edge should have only one response. While implementing we can get multiple response to an edge. Based on these criteria, the canny edge detector first smoothes the image to eliminate and noise. It then finds the image grade to highlight regions with high spatial results [9][10].

6. DCT (Discrete Cosine Transform)

The DCT Transform a signal from spatial illustration into a frequency representation. Lower frequencies are more practical in an image than higher frequencies so if we convert an image into its frequency components and throw away a lot of higher frequency measurements, we decrease the amount of data needed to define the image without losing too much image quality [11].

After using DCT we will get the single image which will define the different structures which we are used for detection.

7. PCA

A new technique created two-dimensional principal component analysis (2DPCA) is developed for image

demonstration. As opposed to PCA, 2DPCA is based on 2D image conditions rather than 1D path so the image background does not need to be converted into a vector proceeding to feature removal. Instead, an image covariance atmosphere is constructed directly using the original image atmospheres and its eigenvectors are derived for image feature removal. To test 2DPCA and estimate its performance, a series of experiments were achieved on three face image databases: ORL, AR, and Yale face databases. The gratitude rate across all trials was higher using 2DPCA than PCA

8.HMM

We define an embedded hidden Markov model (HMM)-based approach for face finding and recognition that uses an effective set of thought vectors acquired from the 2D-DCT constants. The embedded HMM can conservative the two dimensional data improved than the one-dimensional HMM and is computationally a smaller amount complex than the two-dimensional HMM. This model is suitable for face descriptions since it exploits an important facial characteristic: forward faces replacement the same structure of “super states” from top to bottom, and also the same left-to-right structure of “states” inside each of these “super states.”

9. SVM

In machine learning, support vector machines (SVMs, also support vector networks) are supervised learning reproductions with related knowledge algorithms that examine data and diagnose patterns, used for arrangement and reversion analysis. Given a set of exercise examples, each noticeable as belonging to one of two categories, an SVM training algorithm builds a perfect that assigns new samples into one category or the other, making it a non-probabilistic binary direct classifier.

10. Skeletonization

Skeletonization is an process that is performed in order to get the center of an image. Knowing the

National Conference on Current Trends in Engineering, Science and Technology (NACCTEST-2018)

Organized by GF's Godavari College of Engineering, Jalgaon

International Journal of Innovations in Engineering and Science, Special Conference Issue, 2018

www.ijies.net

center of the image or minimum is useful because the original image can be re-formed from it. The smallest of an object is theoretically defined as the locus of middle pixels in the object. Therefore, smallest is used to find out interior construction of the image. This image is a disposed to image. It is particular useful to find out boundaries, small and big dots correctly which we essential for recognition of diseases. Edges and dots will represent us blood container and exudates, hemorrhages of retinal image. These are different feature used for recognition of retinal image.

11. Diabetic Retinopathy DR is divided into various stages. The initial signs of DR are micro aneurysms (MA), dot & blot hemorrhages (HE), cotton-wool spots and exudates that outcome from irregular permeability and non-perfusion of capillaries. These initial signs are known as non-proliferative DR (NPDR). Fluid leaking from retinal vessels indicates a further advancement of the disease. This may lead to sight aggressive diabetic retinopathy, if the outflow is located in the area of most serious vision, the macula. Advanced stage of DR, proliferative DR (PDR), develops from blocked vessels that lead to retinal ischemia and creation of new containers on the surface of the retina either near optic disc (OD) or in the retinal periphery [21]

In 2015, 415 million adults suffered from diabetes mellitus [22]. This number is increasing, and by 2040, it is probable to reach 642 million. Long-time diabetes touches the blood containers also in the eyes, causing diabetic retinopathy (DR). In the case of DR, the blood containers providing the retina may develop thick and weak; causing leaks called hemorrhages (see Fig. 7).

CONCLUSION

In case of detection of disease of eyes using soft computing technique by using Iris tumor detection system(ITDS),Eye tumor detection system, support

machine classifier, Fuzzy logic we will recognize the skin tumor and also increases the identification rate of diseases by the images of eyes.

REFERENCES

- [1] L. Giancarlo, F. Meriaudeau, T. P. Karnowski, Y. Li, K. W. Tobin, Jr., and E. Chaum, "Automatic retina exudates segmentation without a manually labeled training set," in *Proc. 2011 IEEE Int. Symp. Biomed. Imag: From Nano to Macro, Mar. 2011*, pp. 1396–1400.
- [2] K. Huang and M. Yan, "A local adaptive algorithm for micro aneurysms detection in digital fundus images," in *Proc. CVBIA, 2005*, pp. 103–113.
- [3] M. R. Hee, C. A. Puliafito, C. Wong, J. S. Duker, E. Reichel, B. Rutledge, J. S. Schuman, E. A. Swanson, and J. G. Fujimoto, "Quantitative assessment of macular edema with optical coherence tomography," *Arch. Ophthalmic.*, vol. 113, no. 8, pp. 1019–1029, Aug. 1995.
- [4] J. Davidson, T. Ciulla, J. McGill, K. Kles, and P. Anderson, "How the diabetic eye loses vision," *Endocrine*, vol. 32, pp. 107–116, Nov. 2007.
- [5] A. D. Fleming, S. Philip, K. A. Goatman, J. A. Olson, and P. F. Sharp, "Automated micro aneurysm detection using local contrast normalization and local vessel detection," *IEEE Trans. Medical Imaging*, vol. 25, no. 9, pp. 1223–1232, 2006.
- [6] Li Helen K, Horton Mark, Bursell Sven-Erik, Cavallerano Jerry, Zimmer-Galler Ingrid, Tennant Mathew, et al. *Telehealth practice recommendations for diabetic retinopathy. 2nd ed. United States: Telemedicine and e-Health; 2011.*
- [7] Gowthaman R, "Automatic Identification And Classification of Micro aneurysms For Detection of Diabetic Retinopathy" *IJRET: International Journal of Research in Engineering and Technology* eISSN:2319-1163., pISSN: 2321-7308 Volume: 03 Issue:02., Feb-2014
- [8] Paintamilselvi, Shyamala, "A Novel Method To Detect The Fovea of Fundus Retinal Image", *International Journal for Research and Development in Engineering (IJRDE)* www.ijrde.com Vol.1: Issue.1, June-July 2012 pp- 21-25
- [9] Mohamed Ali David Claus "Using The Canny Edge Detector for Feature Extraction and Enhancement of Remote Sensing Images", *Systems Design Engineering, University of Waterloo, IEEE 2001.*
- [10] Hanene Trichili, Mohamed-Salim Bouhleb, Nabil Derbel, Lotfi Kamoun, "A Survey and Evaluation of Edge Detection Operators Application to Medical Images" *IEEE, 2002.*
- [11] Bhawana Tewari, Sonali Dubey "Compression Analysis Between DWT And DCT" *Department of ECE, New delhi 2005*

National Conference on Current Trends in Engineering, Science and Technology (NACCTEST-2018)

Organized by GF's Godavari College of Engineering, Jalgaon

International Journal of Innovations in Engineering and Science, Special Conference Issue, 2018

www.ijies.net

[12] Keith P. Thompson, Qiushi S. Ren, Member, IEEE, and Jean-Marie Parel "Therapeutic and Diagnostic Application of Lasers in Ophthalmology".

Engineering & Technology 24-26 October 2015, Kumamoto University, Japan, ISBN 13: 978-81-930222-1-4, pp 291-295,

[13] R.K.Ghanta, W. Drexler, U. Morgner, F. Kartner, F.P Ippen, J.G.Fujimoto, J.S. Schuman, A. Clermontt, S.Bursell, "Ultrahigh resolution retinal imaging with optical coherence tomography", CLEO 2000

[14] Zhuo Zhang, Feng Shou Yin, Jiang Liu, Wing Kee Wong, Ngan Meng Tan, Beng Hai Lee, Jun Cheng, Tien Yin Wong, "ORIGA-light: An Online Retinal Fundus Image Database for Glaucoma Analysis and Research", 32nd Annual

[15] International Conference of the IEEE EMBS Buenos Aires, Argentina, August 31 - September 4, 2010. Michael D. Abramoff, Senior Member, IEEE, Mona K. Garvin, Member, IEEE, and Milan Sonka, Fellow, "Retinal Imaging and Image Analysis", IEEE Reviews in Biomedical Engineering, VOL. 3, 2010

[16] Arulmozhivarman Pachiyappan, Undurti N Das, Tatavarti VSP Murthy and Rao Tatavarti, "Automated diagnosis of diabetic retinopathy and glaucoma using fundus and OCT images", Pachiyappan et al. *Lipids in Health and Disease* 2012, 11:73 <http://www.lipidworld.com/content/11/1/73>

[17]. J.Jenita Jeba Esther¹, S.G.Gino Sophia² "Detecting\ Optic Disc In Digital Fundus Images Using Stochastic Watershed Transformation" *IJREAT International Journal of Research in Engineering & Advanced Technology*, Volume 2, Issue 1, Feb-Mar, 2014. ISSN: 2320 – 8791

[18] R.C. Gonzalez, R.E. Woods, *Digital Image Processing*, Addison Wesley, Reading, MA, 1992.

[19] Parth Panchala, Ronak Bhojanib, Tejendra Panchal *An Algorithm for Retinal Feature Extraction using Hybrid Approach* page 63 Parth Panchal et al. / *Procedia Computer Science* 79 (2016) 61 – 68

[20] B. Liesenfeld, E. Kohner, W. Piehlmeier, S. Kluthe, M. Porta, T. Bek, et al., A

[21] Jelinek H.F., Cree M.J.. *Automated Image Detection of Retinal Pathology*. ISBN 978-0-8493-7556-9

[22] Aguirre F, Brown A, Cho NH, Dahlquist G, Dodd S, Dunning T. et al. *IDF diabetes atlas. 7th ed. ed., International Diabetes Federation.*; 2015.

[23] B.Jyothia, Y.Madhav Lathab, P.G.Krishna Mohan, V.S.K.Reddy *Integrated Multiple Features for Tumor Image Retrieval Using Classifier and Feedback Methods. International Conference on Computational Modeling and Security (CMS 2016)* pp-4

[24] Nimmy thomas, Therese Yamuna Mahesh, *Detection and Classification of Exudates in Diabetic Retinopathy*, Volume 2, Issue 9, September 2014 ISSN: 2321-7782 pp-297

[25] Goli Haveesh¹, Govardhan Hegde K, Bhargav J Bhatkalkar, Srikanth Prabhu, Sulatha Bhandary, *Glaucoma detection and its classification using image processing and fuzzy classification*, 4th World Conference on Applied Sciences,

A Survey on Speaker Identification System

Leena S. Patil¹, Vishal B. Patil², Varsha P. Patil³, Nikita S. Khachane⁴, Hemraj V. Dhande⁵

^{1,2,3} Student from E&TC Department

Godavari College Of Engineering, Jalgaon Maharashtra

⁴ Student from E&TC Department

S.S.B.T College Of Engineering & Technology, Jalgaon Maharashtra

⁵Assistant Professor From E&TC Department

Godavari College Of Engineering, Jalgaon Maharashtra

⁵hemraj99@gmail.com

Abstract: - The speech processing for providing vast security is more popular day by day. For the purpose of authentication of speech by speaker is widely used. Speaker recognition is the process which can verify and identifies a human from features of voice. The speaker recognition has made great process. But in real life or real situation the environment noise is effected for the performance of speaker recognition systems. This paper studies the performance of speaker recognition system in noisy surroundings. And now a days (in the present) this system is using MFCC (Mel frequency cepstrum coefficients) techniques. The MFCC feature is used along with the VQLBG (Vector Quantization – Limba, Buzo and Gray) differentiate between silence and voice activity and significantly improve the performance of SRS (speaker recognition system) under the noisy conditions. The requires measurement were performed in MATLAB which proving speech signal image recognition in a simple and easy way to used.

Keyword:- MFCC (Mel Frequency Cepstrum Coefficient), VQLBG (Vector Quantization-Limba, Buzo And Gray), SRS (Speaker Recognition System).

INTRODUCTION

Speech is one of the most important way of human communication like finger print, it carries the similarity of the speaker as voiceprint. The Human delivery is a signal inclusive combined types of information, Including words, feelings, language and identity of the speaker.[10] This can be done by developing an automatic speech recognition (ASR) system which allows a computer to recognize the words that a person or a human beings speaks into a mice i.e microphone or telephone and translate it into a written text format. As a result it has possible of being of important mode of interaction between the human and computers.[9] This research works discuss the difficulties of speaker verification. And it can be determining the given speaker

with the help of training set of samples. The main steps of speaker recognition start with the preprocessing of voice signal, perform sampling and quantization, and then feature extraction. At the last step the extracted features are given to a classifier. This field is still under the research at which the allow able feature set that consists with the best special characteristics of each voice which is investigated by the appropriate classifier for every feature set. In this work, the MFCC (Mel frequency cepstrum coefficients) feature are used to design a text dependent speaker identification system. MFCC's are obtained in training and testing phase. Speaker Uttered same words once in a training phase as well as testing phase. Depending on the various function, speaker recognition could be classified into two parts as a identification and a verification of a speaker. [9] To identifying which one of N known speakers is the very analogous to the input voice such called as speaker identification.

The following definitions are the basics needed for understanding speech recognition technology.

Utterance:-

An utterance is the vocalization (speaking) of a word or word that represent a single meaning to the computer. Utterances can be a single word, a few words, a sentence, or even multiple sentences

Speaker Dependence:-

Speaker dependent system are designed around a specific speaker. They generally are more accurate for the correct speaker , but much less accurate for other speaker. They assume the speaker will speak in a consistent voice and tempo. Speaker independent system are designed for a variety of speakers. Adaptive systems usually start as speaker independent systems and utilize

training techniques to adapt to the speaker to increase their recognition accuracy.

Vocabularies:-

Vocabularies are lists of words or utterances that can be recognized by the SR system. Generally, smaller vocabularies are easier for a computer to recognize, while larger vocabularies are more difficult. Unlike normal dictionaries, each entry doesn't have to be a single word. They can be as long as a sentence or two. Smaller vocabularies can have as few as 1 or 2 recognized utterances, while very large vocabularies can have a hundred thousand or more.

Accurate:-

The ability of a recognizer can be examined by measuring its accuracy-or how well it recognizes utterances. This includes not only correctly identifying an utterance but also identifying if the spoken utterance is not in its vocabulary. Good ASR systems have an accuracy of 98% or more. The acceptable accuracy of a system really depends on the application

Training:-

Some speech recognition systems have the ability to adapt to a speaker. When the system has this ability, it may allow training to take place. An ASR system is trained by having the speaker repeat standard or common phrases and adjusting its comparison algorithm to match that particular speaker. Training a recognizer usually improves its accuracy

TYPES OF SPEECH

Speech recognition systems can be separated into different classes by describing what type of utterances they can recognize.

A. Isolated word

Isolated word recognition usually requires each utterance to have quiet on both sides of sample windows. It accepts single words or single utterances at a time. This is having "Listen and Non Listen state". Isolated utterance might be a better name for this class.

B. Connected word

Connected word systems are similar to isolated words but allow separate utterances to be "run together" with a minimum pause between them.

C. Continuous speech

Continuous speech recognition allows users to speak almost naturally, while the computer determines the content. Recognizers with continuous speech capabilities are some of the most difficult to create because they utilize special methods to determine utterance boundaries.

D. Spontaneous speech

At a basic level, it can be thought of as speech that is natural sounding and not rehearsed. An ASR system with spontaneous speech ability should be able to handle a variety of natural speech features such as words being run together [9].

RELATED WORK

In 2004, Jingdong Chen has presented Recognition of noisy speech using dynamic spectral subband centroids [2], which discussed that the irregularity of their widespread popularity as front end parameters for speech recognition. The cepstral coefficient derived from either linear prediction analysis or spectral subband centroid techniques are used for robust speech recognition. It is shown that new dynamic SSC coefficients are more sensitive to noise than the Mel Frequency cepstral coefficient characteristics.

In 2005, Esfandiar Zavarehei has described Speech enhancement using Kalman filter for restoration of short-time DFT trajectories [3]. Which studied that expands the semantic information utilized and tightness of integration during lexical and semantic items. Use of concept sequence modeling, two-level semantic, and joint semantics-lexical modeling. A method of incorporating restarting of Kalman filter after long periods of noise dominated activity in a DFT channel.

In 2008, Chunyi Guo has presented Research on the application of biomimetic computing in speech recognition [4] which discussed that one of the most direct and effective means of human communication, it's natural to apply biomimetic processing mechanisms to automatic speech recognition to solve the existing speech recognition problem. Simulation evolution computation (SEC), artificial neural network (ANN) and fuzzy logic techniques are used. This all three techniques shown the accuracy of speech recognition greater than 95% and also lower the error rate.

In 2009, Negar Ghourchian has presented Robust distributed speech recognition using two stage filtered minima controlled recursive averaging [5] and discussed

that the use of Filtered Minima Controlled Recursive Averaging(FMCR) technique are used, Betterment the accuracy of estimated noise spectrum and to decrease the speech leakage.

In 2010, Richard. M. Stern has presented Minimum variance modulation filter for robust speech recognition. And described that the upgrades speech recognition accuracy as compared to traditional MFCC processing under various back ground error or noise .CMU SPHINX-III speech recognition system, DARPA resource management and well street journal speech corpus techniques are used.[6]

In 2012, Patiyuth Pramkeaw described Improving MFCC based speech classification with FIR filter.[7] Which studied that the way to improvement in the recognition rates of spoken words. Use of Finite Impulse Response (FIR) filter techniques.

In 2013, Shivanker Dev Dhingra, Poonam Pandit presented Isolated speech recognition using MFCC and DTW. Which discussed with MFCC (Mel Frequency cepstral coefficient) and DTW (Dynamic Time Warping), Isolated word detection system is procreate in MATLAB environment method is performing by saving templates of five isolated words. DTW distance between similar words is less than 100 and in discontiguous words is much than 290.[8]

In 2014, Geeta Nijhawan, Dr. M. K. Soni presented Speaker recognition using MFCC and vector quantization. which studied that they made a VQLBG (vector Quantization- limba Buzo and Gray, VAD (Voice Activity Dector) techniques are used in this paper. In this project shows that by using the VAD techniques approach on an average given a 5% error rate shortage compared to just using a speech free segment from the beginning of the utterance for noise modeling.

In 2015, C. Sunitha , E. Chandra described Speaker recognition using MFCC and improved weighted vector Quantization algorithm.[10] Which studied that The speaker verification using weighted vector quantization speech signal are extracted by using MFCC technique where features are extracted using linearly spaved filters in Mel scale compared to other existing technique, This method of MFCC provides the better feature extraction.

In 2016, Khushboo. S. Desai, Heta Pujara presented Speaker recognition from the mimicked speech: A Review. Which discussed that recognition of the speaker

is the task to identify person from the words they are spoken. The recognition is done by the voice characteristics, In this paper, techniques to recognition the mimicked speaker and original speaker are discussed. It can be conclude that prosodic features mimicked speaker recognition does not give efficient result. many techniques are discussed for original and mimicked speaker recognition.[11]

PROPOSED METHODOLOGY

In this paper, we use the MFCC features for text-independent speaker recognition. MFCC is a popular feature extraction technique for speech signals. The main idea behind MFCC features is to imitate the behavior of a human ear. Psychophysical studies have shown that human perception of the frequency contents of sounds for speech signals does not follow a linear scale.

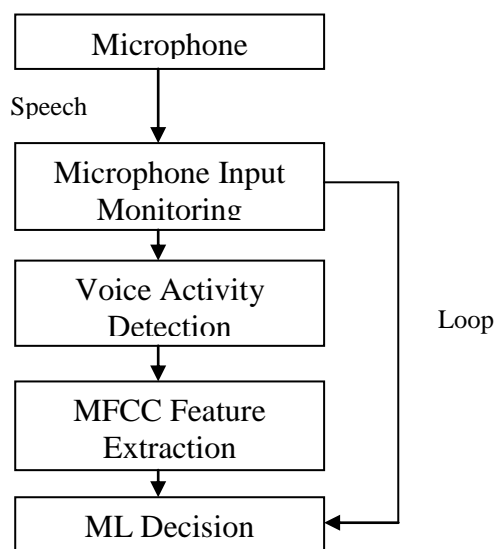

Fig. 1 Block diagram of the Voice Recognition

Generally speaking, a conventional automatic speech recognition (ASR) system can be organized in two blocks: the feature extraction and the modelling stage. In practice, the modelling stage is subdivided in acoustical and language modelling, both based on HMMs as described in Figure.

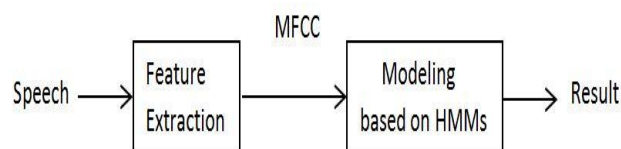
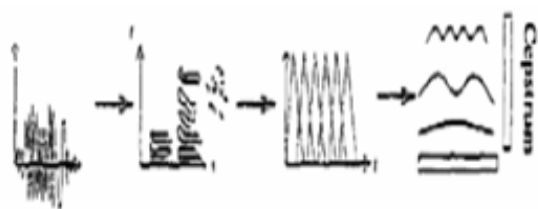

Fig.2. Basic Diagram of MFCC

The feature extraction is usually a non-invertible (lossy) transformation, as the MFCC described pictorially in Figure 2. Making an analogy with filter banks, such transformation does not lead to perfect reconstruction, i.e., given only the features it is not possible to reconstruct the original speech used to generate those features. Computational complexity and robustness are two primary reasons to allow losing information. Increasing the accuracy of the parametric representation by increasing the number of parameters leads to an increase of complexity and eventually does not lead to a better result due to robustness issues. The greater the number of parameters in a model, the greater should be the training sequence.



Signal Time-Frequency Filterbank Cosine Transform Cepstrum

Speech is usually segmented in frames of 20 to 30 ms, and the window analysis is shifted by 10 ms. Each frame is converted to 12 MFCCs plus a normalized energy parameter. The first and second derivatives (Δ 's and $\Delta\Delta$'s) of MFCCs and energy are estimated, resulting in 39 numbers representing each frame. Assuming a sample rate of 8 kHz, for each 10 ms the feature extraction module delivers 39 numbers to the modelling stage. This operation with overlap among frames is equivalent to taking 80 speech samples without overlap and representing them by 39 numbers. In fact, assuming each speech sample is represented by one byte and each feature is represented by four bytes (float number), one can see that the parametric representation increases the number of bytes to represent 80 bytes of speech to 136 bytes. If a sample rate of 16 kHz is assumed, the 39 parameters would represent 160 samples. For higher sample rates, it is intuitive that 39 parameters do not allow reconstructing the speech samples back. Anyway, one should notice that the goal here is not speech compression but using features suitable for speech recognition.

Calculating the features based on MFCCs

The first order delta coefficients are computed by the following equation:-

$$a_i = \frac{\sum_{n=1}^N n(c_{n+i} - c_{n-i})}{2 \sum_{n=1}^N n^2}$$

Cepstral Mean Normalization mathematically is given by,

$$c_i = c_i - \frac{1}{N} \sum_{k=1}^N c_{ik}$$

Now, Liftering is applied according to the following equation,

$$c'_n = \left(1 + \frac{N}{2} \sin \frac{\pi n}{N}\right) c_n$$

Pre-emphasis the first order difference equation,

$$s'_n = s_n - \alpha s_{n-1}$$

CONCLUSION

Speech recognition has been in development for more than 50 years, and has been entertained as an alternative access method for individuals with disabilities for almost as long. In this paper, the fundamentals of speech identification are discussed and its recent progress is investigated. The various approaches available for developing an ASR system are clearly explained with its merits and demerits. The performance of the ASR system based on the adopted feature extraction technique and the speech identification approach for the particular language is compared in this paper. In recent years, the need for speech identification research based on large vocabulary speaker independent continuous speech has highly increased. Based on the review, the potent advantage of HMM approach along with MFCC features is more suitable for these requirements and offers good recognition result. These techniques will enable us to create increasingly powerful systems, deployable on a worldwide basis in future. The MFCC for speech Identification process is fast and simple which works well under constrained environment. From this paper, we increase the level of security.

ACKNOWLEDGMENT

The authors would like to thank E&TC Engineering Department of Godavari College of Engineering, Jalgaon for their technical support and cooperation in providing information.

REFERENCE

- [1] Nitisha Gary, Ashu Bansal, Anu Taneja "Understanding speech recognition system and recognizing hindi language numerals using MATLAB".
- [2] Jingdong Chen .Member, Yiteng (Arden) Huang, Qi Li , Kuldip ,K. Paliwal "Recognition of noisy speech using dynamic spectral subband centroid's" in IEEE SIGNAL PROCESSING LETTERS,VOL.11,No.2 Feb 2004.
- [3] Esfandia Zavarehei , "Speech enhancement using kalman filter for restoration of short-time DFT trajectories" in 2005.
- [4] Hakan Erdogan, Ruhi Sarikaya Yuding Gao Using semantic analysis to improve speech recognition" IEEE 2008.
- [5] Negar Ghourchian, Sid-Ahmed Selouani, Douglas o' "Robust distributed speech recognition using Two-stage filtered minima controlled recursive averaging" In IEEE 2009.
- [6] Yu-hsiang Bosco Chiu, Richard. M. Stem " Minimum variance modulation filter for robust speech recognition " In IEEE 2010.
- [7] Chadawan Ittichaichareon , Patiyuth Pramkeaw "Improving MFCC-Based speech classification with FIR Filter" in international conference on computer graphics simulation and modeling (ICGSM' 2012)July28-29,2012_Pattaya(Thailand) .
- [8] Shivanker Dev Dhingra, Poonam Pandit "Isolated speech recognition using MFCC and DTW "in 2013.
- [9] Harpreet singh,Ashok Kumar bhatala "A Survey on speaker recognition "In IEEE 2013.
- [10] Dr. E. Chandra, Mrs. C. Sunitha "A Review on speech and speaker authentication system using voice signal feature selection and extraction" in 2015.
- [11] Khushboo.S. Desai,Heta Pujara "Speaker recognition from the mimicked speech:A Revie" In IEEE 2016.

Survey Paper on Bimodel Biometric Authentication System

Machhindra R. Javare¹, Utkarsha A. Chaudhari², Sandeepkumar Nishad³, R. V. Patil⁴, Ansari Shafique⁵

^{1,2,3}BE Students, Department of Electronics and Telecommunication
 GF's Godavari College of Engineering, Jalgaon, India
⁴Associate Prof, E&TC dept, ⁵ Assistant Professor E&TC dept
 GF's Godavari College of Engineering, Jalgaon, India Pin 425001
⁴rajendravpatil1966@gmail.com

ABSTRACT:

A new technique for human identification using fusion of both face and speech in which the improve the rate of recognition as compared to the single biometric identification for security development. In this paper we proposed to uses Principle Component Analysis (PCA) as feature extraction techniques in which last/ past year mostly 2D and 3D some use face recognition system. Now we have to use methods as Mel-frequency Centrum Coefficients (MFCC) feature extraction techniques are used for speech recognition and the hidden Markov model (HMM) is used to calculate the likelihoods in the MFCC extracted features to make the decision about the spoken words.

Keywords : Biometrics, PCA-Principle component Analysis, MFCC-Mel-Frequency-Ceswtrum Coefficient, HMM-Hidden Markov Model, ASR-Automatic speaker recognition system.

INTRODUCTION

The Biometric identity authentication system is based on the biological characteristics of a person, such as face, voice, fingerprint, iris, gait, hand geometry or signature. Identity authentication using the face or the voice information is a challenging research area that is currently very active. We study the fusion of speech and face in a recognition system for taking a final decision (i.e. accept or reject identity claim). We evaluate the performance of each system differently then we fuse the result and compare the performances.

LITERATURE SURVEY

1. Survey and review on Face recognition system – A challenge, published by Dr. Pramod Kumar, Mrs. Monika Agarwal, Miss. Stuti Nagar.

The 2D and 3D dimensional picture fail the reason is that-

- (i) 2D picture to compare it with the image sorted in database, but these programs did not the succeed only.
- (ii) If the person is looking just to the camera of course any one suspect will be warned that he/she will see a camera in place.
- (iii) There lies the problem where this fails by depending on the 2D system.

And that about 3D system-

- (i) The 3D system for face recognition based on the pattern of three-dimensional (3D).
- (ii) Where special cameras win captured images of three-

- (iii) Using the special main features of each face that are not changed significantly with time, such as eye hole, distance between the eyes, nose shape and other[1]

2. Survey and review 2D and 3D face recognition publish by . Andrea F. Abate, Michele Nappi, Daniel, Gabriele Sabatino.

In this paper it was inferred that the automatic face recognition, the old and the new in this pattern recognition problem, which is very hard to solve due to its non-linearity. We can think of it as a template matching problem, where recognition has to be performed in a high-dimensional space. Since Higher the dimension of the space is more the computation we need to find a match a dimensional reduction technique is used to project the problem in a lower dimensionality space indeed. [2]

3. Survey and review on face recognition techniques. Publish by – Rabia Jafri and Hamid R. Arabnia

In this paper we shows that the face recognition from intensity images, there are some types featured-based, Holistic, Statistical, multiple classifier systems, face recognition from video sequences, face recognition from other sensory inputs like 3D model based and intra-red. These are different on face recognition technique. [3]

4. Survey and review- All Embedded HMM based approach for face detection and recognition. Published by – Ara V. Nefian and Manson H. Hayes III.

In this paper the face recognition system work on embedded HMM (Hidden Markov Model). The embedded HMM model, the two dimensional data better than the one dimensional HMM and is computationally less complex than the two-dimensional HMM.[4].

5. Survey and review – A New face recognition method based on SVD Perturbation for single Example Image per person. Published by – Daoqiang Zhang, Songcan Chen and Zhi-Hua-Zhou.

In this paper the use of new face recognition SVD perturbation is elaborated. There are two algorithms, in first algorithm; the original image is linearly

National Conference on Current Trends in Engineering, Science and Technology (NACCTEST- 2018)
Organized by GF's Godavari College of Engineering, Jalgaon
International Journal of Innovations in Engineering and Science, Special Conference Issue, 2018
www.ijies.net

combined with its derived image gotten by perturbing the image matrixes. Singular values and then principle component analysis (PCA) is performed on the joined images and second algorithm the deprived images are regarded as independent images that could augment training image set, and then PCA is performed on all the training images available, including the original ones and derived one.[5]

6. Survey and review on Image-based Face Detection and recognition “State of the Art”.

Published by – Faizan Ahmad, Aaima Najam and Zeeshan Ahmed.

In this paper it is proposed that, the advantages of face based identification over the other biometric and uniqueness and acceptance. Human face is a dynamic object having high degree of variability in this appearance; the makes face detection a difficult problem in computer vision. In this field accuracy and speed of identification is a main issue.[6]

7. Survey and review for face recognition technologies.

Published by – Kavita, Ms. Manjeet Kaur.

In this paper, there is a literature survey of last 40 years. Face recognition research paper are the face recognition system are found as-

- (i) Facial expression
- (ii) Ageing
- (iii) Illumination variation
- (iv) Pose change
- (v) Scaling factor (i.e. size of the image)
- (vi) Frontal Vs profile
- (vii) Presence and absence of spectacles, beard, mustache etc.
- (viii) Occlusion due to scarf, mast or obstacles in front. [7]

8. Survey and review on speech recognition techniques for mobile devices.

Published by-Dmitry Zaykovskiy

This paper presents the main three-technologies in wireless communication link that are – embedded speech recognition system, Network speech recognition system (NSR) and Distributed Speech Recognition (DSP). The Critical analysis of the development in the field of mobile environments open its sues, pros and cons the different methodologies and techniques are highlighted.[8]

9. Survey and review on Automatic Recognition for Under-Resourced Languages : A Survey

Published by – Laurent Besacier, Etienne Barnmard, Alexey Karpov, Tanja Schultz.

In this paper the main part of the paper is a literature review of the recent (last 8 years) contributions made in ASR for under-resourced languages and some of past projects and future trends.[9]

10. Survey and review on Human identification using face and voice recognition.

Published by – Ishwar Jadhav, V. T. Gaikwad,

Gajanan U. Patil.

In this paper proposed new technique for human identification using fusion of both face and speech, the various methods are used. Principle component analysis (PCA). The Mel-frequency cestrum coefficients (MFCC). The Hidden Markov model (HMM) and the result is in acceptable or rejected decision about the human identification [10]

METHODOLOGY

We have proposed the face and voice authentication system as

Speaker identification Module :

The main idea behind MFCC features is to imitate the behaviour of a human ear. The human perception of the frequency contents of sounds for speech signals does not follow a linear state. Therefore Mel-frequency scale has linear frequency spacing below 1000 Hz and logarithmic spacing above 1 KHz. The reference point, the pitch of a 1 KHz tone, 40 dB above the perceptual hearing threshold is defined as 1000 Mels.

The face Recognition Module :

The PCA is a statistical dimensionality reduction method in which produces optimal linear least squares decomposition of a training set Kirby and Sirovich (1990) applied PCA to represent face and Fruk and Pentland (1991) extended PCA to recognizing face. PCA based recognition algorithm, the input is training set t_1, \dots, t_N of N facial images such that resemble mean of the training set is zero.

SELECTION OF SOFTWARE

The bases PCA are implemented for face recognition by using MATLAB and for face are captured and tested using this GUI. Speaker Identification is implemented with MATLAB.

CONCLUSION

We conclude that the above mentioned systems are some how have drawbacks. If we use at least two identities of Human then Recognition of human will be better.

So we are going to prepare “Bimodal Biometric Authentication System” for above so and purpose.

ACKNOWLEDGEMENT

The authors are thankful to Mr. R. V. Patil Sir and Electronics and Telecommunication Department for Providing valuable suggestion for this work.

National Conference on Current Trends in Engineering, Science and Technology (NACCTEST- 2018)
Organized by GF's Godavari College of Engineering, Jalgaon
International Journal of Innovations in Engineering and Science, Special Conference Issue, 2018
www.ijies.net

REFERENCES

- [1] Dr. Pramod Kumar, Mrs. Monika Agarwal, Miss. Stuti Nagar *A Survey on Face Recognition System - A Challenge*, International Journal of Advanced Research in Computer and Communication Engineering Vol. 2, Issue 5, May 2013
- [2] Andrea F. Abate, Michele Nappi, Daniel Riccio, Gabriele Sabatino, *2D and 3D face recognition: A survey*, Science Direct, Dipartimento di Matematica Informatica, Università di Salerno, 84084 Fisciano (SA), Italy, Available online 26 January 2007
- [3] Rabia Jafri and Hamid R. Arabnia, *A Survey of Face Recognition Techniques*, Journal of Information Processing systems, Vol. 5, No. 2, June 2009.
- [4] Ara V. Nefian and Monson H. Hayes III, *An Embedded HMM-Based approach for Face Detection and Recognition*, Georgia Inst. of Technology, School of Electrical and Computer Engg., Centre for Signal and Image Processing, Atlanta, GA 30332.
- [5] Daoqiang Zhang et.al *A New Face Recognition Method based on SVD Perturbation for Single Example Image per Person*, Nanjiang Univ., Nanjing 210093, China.
- [6] Faizan Ahmad et.al (2012) *Image Based Face Detection and Recognition*, IJCSI International Journal of Computer Science Issues, Vol.9, Issue 6, No.1 Nov. 2012.
- [7] Kavita, Ms. Manjeet Kaur (2016). *A Survey paper for Face Recognition Technologies*, International journal of Scientific and research publications, vol. 6, Issue 7, July 2016.
- [8] Dmitry Zaykovskiy (2006). *Survey of the Speech Recognition Techniques for Mobile Device*, SPECOM 2006, St. Petersburg 25-20 June, 2006.
- [9] Laurent Besacier, Etienne Barnard, Alexey Kaprov, Tanja Schultz , *Automatic Speech Recognition of Under-Resourced languages : A Survey*.
- [10] Ishwar S. Jadhav, V. T. Gaikwad, Gajanan U. Patil *Human Identification using Face and Voice Recognition (IJCSIT)* International Journal of Computer Science and Information Technologies, Vol. 2 (3) , 2011, 1248-1252

National Conference on Current Trends in Engineering, Science and Technology (NACCTEST- 2018)
 Organized by GF's Godavari College of Engineering, Jalgaon
International Journal of Innovations in Engineering and Science, Special Conference Issue, 2018
 www.ijies.net

Biometric Authentication By Using Face Recognition

Parmeshwar V. Wagh¹, Harshal R. Patil², Siddheshwar S. Tambare³, I. S. Jadhav⁴, D.P. Marathe⁵

^{1,2,3}BE Students, Department of Electronics and Telecommunication
 GF's Godavari College of Engineering, Jalgaon, India

^{4,5}Associate prof in department of Electronics and Telecommunication
 GF's Godavari College of Engineering, Jalgaon, India

⁴ishwar.jadhav@rediffmail.com

Abstract: Currently there are vast development in biometric authentication technology so password hacking is reduced by day by day. In past year mostly thumb scanning was used. Face recognition technology is used to automatically identify a person like as he open account by using his own password. In this paper we are focus to directly capture information about the face shape using face recognition. Face recognition is used for highly secured system. In this paper we proposed the technique for human identification which can substantially improve the rate of recognition as compared to the other biometric identification. we propose the best, highly secured device, does not hack, all this features are developed by face recognition.

Keywords- face features, feature selection, local binary patter, camera, moduls of proposed system.

INTRODUCTION

In general, face recognition problem can be briefly defined as the process of matching a new input face to the existing known individuals in the database. In machine learning practice, it is a supervised learning problem. More specifically it is a multi valued classification task with as many classes as there are individuals whose faces are stored in the face database. Face recognition can be applied for a wide variety of problems like image and film processing, human-computer interaction, criminal identification etc. This has motivated researchers to develop computational models to identify the faces, which are relatively simple and easy to implement. The model developed in [1] is simple, fast and accurate in constrained environments. Our goal is to implement the model for a particular face

and distinguish it from a large number of stored faces with some real-time variations as well. The scheme is based on an information theory approach that decomposes face images into a small set of characteristic feature images called 'Eigen faces', which are actually the principal components of the initial training set of face images. Recognition is performed by projecting a new image into the subspace spanned by the Eigen faces ('face space') and then classifying the face by comparing its position in the face space with the positions of the known individuals. Recognition under widely varying conditions like frontal view, a 45° view, scaled frontal view, subjects with spectacles etc. are tried, while the training data set covers a limited views. Further this algorithm can be extended to recognize the gender of a person or to interpret the facial expression of a person. The algorithm models the real-time varying lighting conditions as well. But this is out of scope of the current implementation.

LITERATURE SURVEY

M Vadiraj described that in each and every organization attendance monitoring is made as one of the most important task. Many traditional methods have been proposed for the same. This paper provides an efficient method for marking attendance which is based on facial recognition of an individual. In this method the images of the students are captured in a group and the faces which are detected are segmented. Then the segmented images are verified with the database of the class. Using a GSM technology, notification of absence will be sent through SMS for the particular student [1]

National Conference on Current Trends in Engineering, Science and Technology (NACCTEST- 2018)
 Organized by GF's Godavari College of Engineering, Jalgaon
International Journal of Innovations in Engineering and Science, Special Conference Issue, 2018
 www.ijies.net

Mansi Patange mentioned that student record maintenance is carried out manually by teachers through roll calling or by passing an attendance sheet.

The drawbacks of this method are time consuming, prone to errors and proxy attendance. More over digital assimilation of records is tedious since teachers need to fill in the details in the database by themselves to generate reports. In manual and digital records consistency also needs to be maintained. In the recent years, automated systems that have evolved use standard biometrics concepts. These systems are intrusive in nature and require expensive gadgetry. Thus our project design makes use of facial detection and recognition algorithms like to identify the students in the image captured by a basic camera. This image is uploaded in the software by using a USB cable where several algorithms detect the faces and compare it to the student image database in recognition phase. Daily attendance gets updated in the database automatically thereafter [2]

The first step is normalization of the input image. The goal of the normalization step is to transform the facial image into a standard format that removes or attenuates variations that can affect recognition performance. This step consists of four sub steps. The first sub step low-pass filters or compresses the original image. Images are filtered to remove high-frequency noise. An image is compressed to save storage space and reduce transmission time. The second sub step places the face in a standard geometric position by rotating, scaling, and translating the center of eyes to standard locations. The goal of this sub step is to remove variations in size, orientation, and location of the face in an image.

The third sub step masks background pixels, hair, and clothes. This prevents image variations that are not directly related to the face from interfering with identification process. The fourth sub step attenuates illumination variation among images, which is a critical factor in the algorithm performance.

The second step performs the PCA decomposition on the training set, which produces the eigenvectors and Eigen values. The third step identifies the face in a normalized image the face in a normalized image, and consists of two sub steps. The first sub step projects the image into face space. The critical parameter in this sub step is the subset of eigenvectors used to represent the face. The second sub step identifies faces with a nearest-neighbor classifier. Or, more precisely, the classifier ranks the gallery images by similarity to the probe. The critical design decision in this step is the similarity measure in the classifier. We presented performance result using L1 distance, L2 distance, angle between feature vectors, and Mahalanobis distance. Additionally, we created three new similarity measures by combining the distance with the L1, L2 and angle similarity measures.

PROPOSED DESIGN:

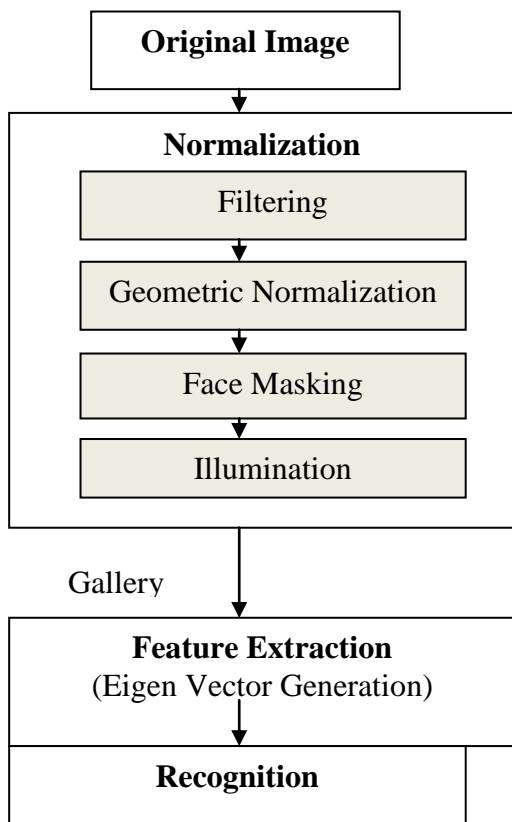

METHODOLOGY

- a. An automated mechanism that scans and captures a digital or an analog image of living personal characteristics. (Enrollment module)
- b. Another entity which handles compression, processing, storage and compression of the captured data with stored data (database)
- c. The third interfaces with the application system (identification module)

National Conference on Current Trends in Engineering, Science and Technology (NACCTEST- 2018)
 Organized by GF's Godavari College of Engineering, Jalgaon
International Journal of Innovations in Engineering and Science, Special Conference Issue, 2018
 www.ijies.net

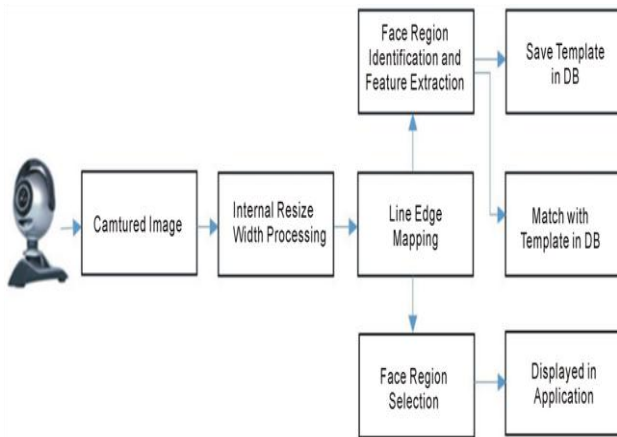

Fig.2-procces of face recognition

User interface captures the analog or digital image of the person's face. In the enrollment module the obtained sample is pre-processed and analyzed. This analyzed data is stored in the database for the purpose of future comparison. The database compresses the obtained sample and stores it. It should have retrival property also that is it compares all the stored sample with the newly obtained sample and retrieves the matched sample for the purpose of verification by the user and determine whether the match declared is right or wrong.

The verification module also consists of a pre-processing system. Verification means the system checks as to who the person says he or she is and gives a yes or no decision. In this module the newly obtained sample is pre-processed and compared with the sample stored in the database. The decision is taken depending on the match obtained from the database. Correspondingly the sample is accepted or rejected.

Instead of verification module we can make use of identification module. In this the sample is compared with all the other samples stored in the database. For each comparison made a match score is given. The decision to accept or reject the sample depends on this match score falling above or below a predetermined threshold.

APPLICATIONS

The natural use of face recognition technology is the replacement of PIN, physical tokens or both needed in automatic authorization or identification schemes. Additional uses are automation of human identification or role authentication in such cases where assistance of another human needed in verifying the ID cards.

There are numerous applications for face recognition technology:

Government Use

a. Law Enforcement: Minimizing victim trauma by narrowing mug shot searches, verifying Identify for court records, and comparing school surveillance camera images to know child molesters.

b. Security/Counterterrorism. Access control, comparing surveillance images to Know terrorist.

c. Immigration: Rapid progression through Customs.

Commercial Use

a. Day Care: Verify identity of individuals picking up the children.

b. Residential Security: Alert homeowners of approaching personnel

c. Voter verification: Where eligible politicians are required to verify their identity during a voting process this is intended to stop 'proxy' voting where the vote may not go as expected.

d. Banking using ATM: The software is able to quickly verify a customer's face.

ADVANTAGES

1. The face detection system is used to bring children from school securely
2. No one can fraud bank employees due to face detection system
3. A person can not vote twice because of the face detection system

National Conference on Current Trends in Engineering, Science and Technology (NACCTEST- 2018)
Organized by GF's Godavari College of Engineering, Jalgaon
International Journal of Innovations in Engineering and Science, Special Conference Issue, 2018
www.ijies.net

4. The face detection system can not be accessed by unknown person without permission from the residential area

DISADVANTAGE

1. facial recognition system uses camera technology which is not yet present as standard equipment in all the pcs thus it will create problem.

CONCLUSION

In the existing system, the face detection system is a way of one or two face part like eyes, nose, lips but In propose design next person covered the face with plastic surgery, but they can be detected by face detection system.

REFERENCE

- [1] M.Vadiraj et.al "Face Recognition Based Attendance Monitoring System" International Journal of Emerging Research in Management &Technology, Vol.5, May 2016.
- [2] Mansi Patange et.al. "A conceptual model of automated attendance System using image processing" International Journal of Advanced Research in Computer and Communication Engineering Vol.4, October 2015
- [3] Ching-Han CHEN, Chia-Tec HU, "Face Authentication System for Information Security".
- [4] Anthony Ronald Grue, "Facial Recognition: Limited Application in Safety and Security".
- [5] Keren Tan, Weiming Chen, Rong Yang, "A PCA-based feature extraction method for face recognition".

National Conference on Current Trends in Engineering, Science and Technology (NACCTEST- 2018)
 Organized by GF's Godavari College of Engineering, Jalgaon
International Journal of Innovations in Engineering and Science, Special Conference Issue, 2018
 www.ijies.net

LITERATURE SURVEY OF INDUSTRIAL MONITORING & FAULT DETECTION

Ketan Pralhad Jadhav¹, H. T. Ingale², V. D. Chaudhari³, S.K.Chaudhari⁴

¹ PG Student, GF's Godavari College of Engineering, Jalgaon, India, 425001

^{2,3} Assistant Professor, Godavari College of Engineering, Jalgaon, India, 425001

⁴ Assistant Professor, SSGB College of Engineering, Bhusawal, India, 425001

¹kpjadhav22@gmail.com

Abstract – Monitoring and controlling is the heart of industrial automation applications and thus, a time response mechanism is required to be able to implement such systems. This project presents a survey of Implementing Real Time Systems for industrial automation applications. Recently, PLCs have dominated industrial automation implementations but however, they do present some challenges especially in meeting real time constraints due to its centralized control and cyclically scanned program execution mechanisms. This paper proposes an alternative implementation approach using FreeRTOS platform that can act as a benchmark for time bound services. This would help in having a hybrid system that can work with PLCs and/or where possible replace PLCs for deterministic service delivery. In this system we have monitor some parameter which is difficult to measure by an instrument manually like Temperature, Humidity, Voltage, Current, Light Intensity etc.

These all parameter are measured by an precise sensors and comparator using microcontroller. All sensors output is connected to the microcontroller (ARM) I/O port where they receive the data and perform the control action on output devices.

Keywords- ARM, Sensors, Industrial Parameter Monitoring, IoT etc.

INTRODUCTION

In recent few years, science has made great progress. Automation makes many industries more dynamic and the Internet of Things (IoT) has brought about a radical change in world, still industrial

monitoring field requires more manual power to monitor and control the industrial parameters such as temperature, humidity, voltage, current, pressure etc. at present. This is one of the most upcoming issues in the industrial sectors. If the parameters are not monitored and controlled properly due to unavoidable manual error, it leads to a harmful situation. Sometimes, if this control process may not handle properly, it results in occurrence of major accidents. With the embedded technology, it is very easy to overcome the greater issues in industrial automation monitoring and controlling.

In industrial automation parameters can be monitor by the use of various sensors such as temperature sensor, voltage and current sensor, humidity sensors and the sensed values processed by microcontroller (here ARM LPC2148 microcontroller is used). The processed values can be displayed through Monitor of PC or Mobile Display or using IoT at remote location to take an immediate control action.

In this system we have monitor some parameter which is difficult to measure by an instrument manually like

- a) Temperature
- b) Humidity
- c) Voltage
- d) Current
- e) Light Intensity

These all parameter are measured by an precise sensors and comparator using microcontroller. All sensors output is connected to the microcontroller (ARM) I/O port where they receive the data and perform the control action on output devices. The whole system can be monitor on display OR PC OR mobile easily and can access at remote location using IoT.

National Conference on Current Trends in Engineering, Science and Technology (NACCTEST- 2018)
 Organized by GF's Godavari College of Engineering, Jalgaon
International Journal of Innovations in Engineering and Science, Special Conference Issue, 2018
 www.ijies.net

OBJECTIVE OF THIS SURVEY

The end of the 20th century has brought important new trends in all industries particularly in terms of engineering. The main consequences to apparel manufacturing have been a constant increase of individual production orders, product and materials variety and much smaller order quantities. This fact posed new requirements on the production systems and equipment: both have to be flexible and reliable. In the case of the equipment, this means that quicker set-up times are required whenever process changes and that quality assurance has to be much more efficient. Managing this situation with the traditional machine set-up and process planning methods is difficult. Better control and predictability of the processes are required.

EXISTING SYSTEMS

In the current scenario of Industry, monitoring and control of parameters such as real time monitoring; a production (process) monitoring is a system that is used in real time to record production line problems. It is constructed using programmable logic controller and sensors to collect data from production lines, real time monitoring process shares many similarities with various processes in the unit cycle time and can vary considerably but instrumentation is limited and inefficient for fault detection. To monitor the existing system from remote location is also not possible in current system. Technician need to reach at site location and check for error occurred. Technician read the existing program running on the system using software and hardware interfacing and then shared with the supervisor at remote location using TeamViewer Software or using some other software. Due to this scenario, the troubleshooting process consumes more time.

METHODOLOGY

After studying the various aspects about the methods, technologies used in earlier systems, we have tried here to propose few modifications that can make the industrial parameter more effective. With the rapid development of upcoming technologies, ARM and IoT have emerged as a boon, thus accelerating the rate of development. Due to the enormous growth in upcoming technologies, humans are getting adapted to them in various ways. Wireless communication has brought a revolutionary change in field of communication. These wireless technologies aim to exchange data wirelessly

providing a wide range of applications. Depending on the communication range, controllability, application and many other factors, the suitable one is selected. Industrial parameter need timely check up and very time efficient response. This survey helps us in developing a very time efficient system for industrial parameter monitoring in various industries. Internet of Things (IoT) has provided a promising opportunity to build powerful industrial systems and applications by leveraging the growing ubiquity of RFID, wireless, mobile and sensor devices. A wide range of industrial IoT applications have been developed and deployed in recent years. In an effort to understand the development of IoT in industries, this paper reviews the current research of IoT, key enabling technologies, major IoT applications in industries and identifies research trends and challenges [1].

INDUSTRIAL PARAMETER MONITORING CONCEPT

In industry parameters like voltage, current, temperature, humidity, light intensity and pressure monitoring is one of the most critical thing and it should be done on very fine precision. Most of the accidents are occurred due improper monitoring and implementation of system. This improper monitoring may occurred due human error, improper load balancing, improper component selection etc. In other way particularly in agricultural field there are some parameters like temperature; humidity plays a vital role growth of that plant. Overall, the parameter monitoring is very important aspect in industry.

1. A recently released data by National Crime Records Bureau (NCRB) revealed Gujarat witnessed highest number of deaths in industrial accidents in 2014. Twenty three workers died in industrial accidents in the state last year. Gujarat is ahead of other heavily industrialized states like Maharashtra, Karnataka, Andhra Pradesh and Tamil Nadu. These workers died on duty in machinery-based industrial sector due to accidents at plants. Also, 22 workers were injured last year while working in various industries.
2. Mumbai is the most dangerous city in the country as far as fires caused by short
3. -circuit go. From 2009 to 2013, 285 short-circuit-caused fires occurred in Maharashtra's capital city, compared to 196 in Delhi, which is second on a list released by the National Crime Records Bureau (NCRB)

National Conference on Current Trends in Engineering, Science and Technology (NACCTEST- 2018)
Organized by GF's Godavari College of Engineering, Jalgaon
International Journal of Innovations in Engineering and Science, Special Conference Issue, 2018
www.ijies.net

a little over a month ago. The incidents, brought into focus because of Friday's Vashi hotel and Thane coaching class fires, were reported from commercial and residential buildings. Experts say short-circuits usually occur because people use poor equipment or do not maintain them.

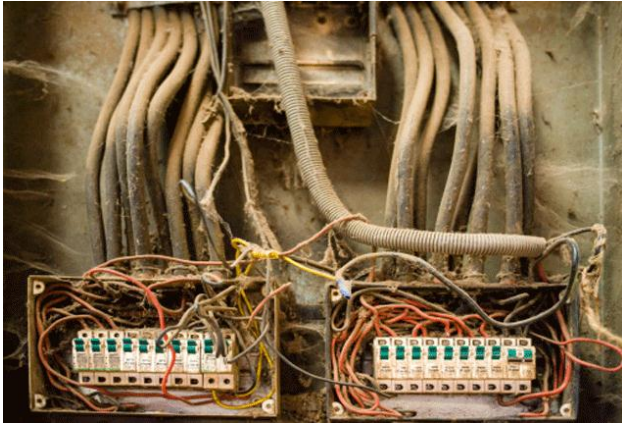

Fig.1. Fault occurred due to poor component selection or No maintenance

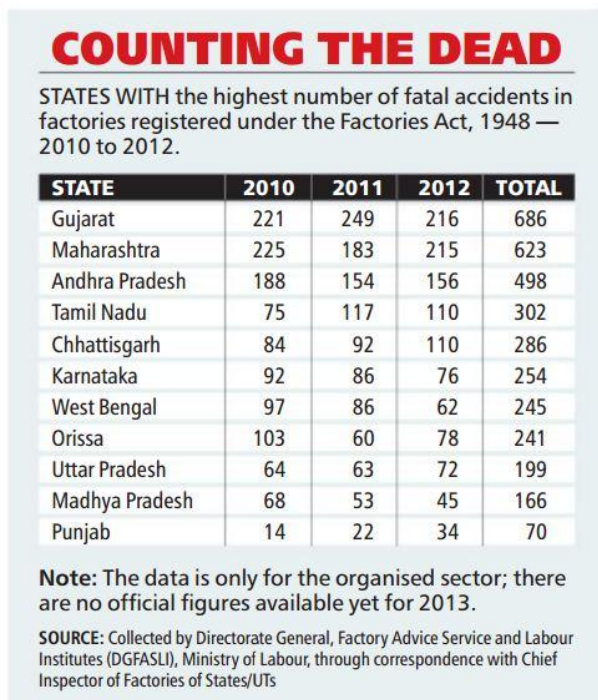

Fig.2. Comparative survey of deaths due to Industrial Accidents

Supervisor has to take care of process being executed in industry. All the parameter should inspect particular time interval. Presently technicians take the reading manually and fill the site inspection report. But here we use Real Time Clock (RTC) which read time and date and can

make a log of parameters we are monitoring. On this tray, all medicine doses will already be placed by doctor according to patient condition. This is the purpose of robotic trolley which is nothing but a line following robot. It has been showed in [2] that IoT has huge potential in terms of data collection and transmission services. It uses a system based on IoT for monitoring with higher precision. We can add intelligent control program with good connectivity and interchanging capability.

Survey carried out in developing this system mainly focuses on achieving following objectives:

1. Monitoring system status using sensors like voltage and current sensor, temperature and humidity sensor and light intensity with LDR.
2. Alert Panel for giving alert signal in case of emergency
3. IoT for remote access

With the aim of achieving the foresaid goals, we have worked on various systems used by researchers and we have thus evaluated following block diagram. Collection of data capacity [5] will collect the data using sensor and pass this signals to embedded systems. Embedded system includes ARM microcontroller, and Wi-Fi module interface. ARM is used as it can easily interfaced with various sensors and process on it with very fast speed as ARM need only 1 clock cycle to execute instruction. The changes in system sensed using the sensors as inputs. ARM is programmed using the Keil uvision 4.0 software and embedded C programming language.

WHY ARM7

1. Bus Width: 32-bit (Generally), also available in 64-bit.
2. Communication protocol: UART, USART, LIN, I2C, SPI, CAN, USB, Ethernet, I2S, DSP, SAI etc.
3. Speed: 1 clock / instruction cycle
4. Memory: FLASH, SDRAM, EEPROM
5. Power Consumption: Low
6. Cost: Low
7. Other Features: High Speed Operation

PURPOSE OF USING IOT TECHNOLOGY IN OUR WORK

Here we are using this technology for remote location of industrial parameter such as voltage, current, temperature, humidity and light intensity. In IoT

National Conference on Current Trends in Engineering, Science and Technology (NACCTEST- 2018)
Organized by GF's Godavari College of Engineering, Jalgaon
International Journal of Innovations in Engineering and Science, Special Conference Issue, 2018
www.ijies.net

projects, all the physical objects (things) are connected together using internet infrastructure. "Internet of Things" IoT has increasingly become a topic of conversation with respect to the emerging technologies. Broadband Internet is easily available and the cost of connecting it is decreasing, more devices are being created with Wi-Fi capabilities and sensors built into them, technology costs are going down, and Smartphone penetration is sky-rocketing. All of these things are creating a "perfect boom" for the IoT. This is the concept of using IoT here which will basically connect any device with an on and off switch to the Internet (and/or to each other).

OUR PRAPOSED SYSTEM

Proposed system works on the basis of below shown block diagram.

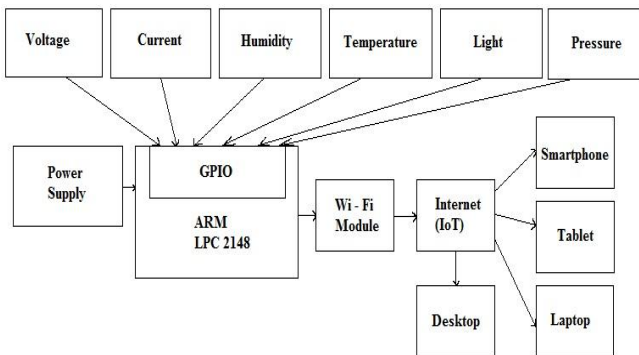

Fig.3. System Block Diagram

Algorithmic steps involved in working of this system:

1. The proposed system will continuously monitor the four sensors.
2. If any parameter viz. voltage, temperature, current, humidity or light intensity mismatches with the standard mentioned value, alert signal will sound.
3. Same time, alert message will be shown on the display inside the supervisor's unit.
4. ARM controller will alert the incharge supervisor of unit
5. By the time, supervisor take the action, system will be turn off.
6. Supervisor will come and check the abnormal conditions and take appropriate action.
7. If fault is left unattended or untreated then again an alert signal will sound and display alert inside the supervisor's unit

8. If the supervisor is at remote location and needs to check the system environment, he can check it using IoT.

CONCLUSION

Here, proposing the idea to monitor the critical industrial parameter like temperature, humidity, voltage, current, solenoid value using sensor in Real time. The existing model has to monitor the temperature and humidity value using microcontroller. The result of proposing idea is more secure to keep the monitoring data in real time $\mu\text{C}/\text{OS-II}$. In future, ability to add some more tasks to monitor, such as employee authentication checking, data logging of cctv camera and etc. The values of the monitoring data in real time are displayed on the LED and Buzzer for intimation of warning.

REFERENCES

- [1] Li Da Zu "Internet of Things in Industries: A Survey" *IEEE Transaction on Industrial Informatics*, vol. 10, no.4, November 2014.
- [2] Charith Perera, Chi Harold Liu, Srimal Jayawardena, Min Chen "A Survey on Internet of Things From Industrial Market Perspective" *IEEE Translations and content mining are permitted for academic research only.*, vol. 2, December 2014.
- [3] SN Ilakkiya, M Ilamathi, J Jayadharani, RL Jeniba and C Gokilavani "A survey on recent trends and applications in embedded system" *IJAR* 2016; 2(8): 672-674.
- [4] Vicent Rutagangibwa, Babu Krishnamurthy "A Survey on The Implementation of Real Time System for Industrial Automation" *IJRST*, vol.1, Issue 7, December 2014.
- [5] Siyuan Chen, Shaojie Tang, Minsu Humang, Yu Wang "Capacity of Data Collection in Arbitrary Wireless Sensor Networks" *IEEE INFOCOM* 2010.
- [6] Shashikant Sing, Dipankar Pandit "Emerging Trends of Embedded System for Industrial Applications" *International Journal of Advances in Engineering*, 2015.
- [7] Ali Ziya Alkar, Mehmet Atif Karaca, "An Internet-Based Interactive Embedded Data-Acquisition System for Real-Time Application", *IEEE TRANSACTIONS ON INSTRUMENTATION AND MEASUREMENT*, VOL. 58, NO. 3, MARCH 2009.
- [8] Sathish Kumar Yegireddi, A.V.S.Pradeep, Budireddi Siva Prasad "Embedded based Industrial

National Conference on Current Trends in Engineering, Science and Technology (NACCTEST- 2018)
Organized by GF's Godavari College of Engineering, Jalgaon
International Journal of Innovations in Engineering and Science, Special Conference Issue, 2018
www.ijies.net

Monitoring System Implementation through ARM and GSM", IJETR, ISSN: 2321-0869 (O) 2454-4698 (P), Volume-6, Issue-2, October 2016.

[9] Kallapa, B. B. Tigadi "Industrial Safety Parameters Monitoring in IOT Environment", IJAREEIE, vol.5, Issue 6, June 2016.

National Conference on Current Trends in Engineering, Science and Technology (NACCTEST- 2018)
 Organized by GF's Godavari College of Engineering, Jalgaon
International Journal of Innovations in Engineering and Science, Special Conference Issue, 2018
 www.ijies.net

A Survey on Robotics in Medical Field

Roshani Sonar¹, Hemraj V. Dhande², R. V. Patil³, H.T. Ingale⁴

¹ PG Scholar, ^{2,3} Assistant Professor, ³ Asso. Professor

^{1,2,3,4} Dept. Of E&TC Engg, GF's Godavari College of Engineering, Jalgaon, Maharashtra, India. Pin-425001
 2hemraj99@gmail.com

Abstract – Robots have taken a great consideration in the medical field. The term medical robotics has often been construed to refer strictly to surgical procedures. However, due to its accuracy, repeatability, and indefatigability, robotic technology is increasingly affecting the entire healthcare sector through advances in diagnosis, preoperative planning, surgery, postoperative evaluation, acute rehabilitation, and chronic assistive devices. Information and communication technology (ICT) and mechatronics play a basic role in medical robotics and computer-aided therapy. The basic concepts of computer-integrated surgery, surgical CAD/CAM, and surgical assistants, it discusses some of the major design issues particular to medical robots.

Keywords – Robotics, ICT, Computer-integrated Surgery, Surgical CAD/CAM

INTRODUCTION

During the last 45 years, robotics research has been aimed at finding solutions to the technical necessities of applied robotics. This evolution has been dominated by human necessities. Medical robotics is a promising field that really took off in the 1990s. Medical robots assist in operations on heart-attack victims and make possible the millimeter-fine adjustment of prostheses. There are, however, many challenges in the widespread implementation of robotics in the medical field, mainly due to issues such as safety, precision, cost and reluctance to accept this technology. The field of medical robotics is expanding rapidly and results are impressive as a large number of commercial devices are being used in hospitals. Robotics systems for surgery are computer-integrated surgery (CIS) systems first, and “medical robots” second. Robot and Robotics technologies represented a practical application of physics, computer science, engineering and mathematics.

It provides a very powerful and flexible approach to demonstrate a variety of engineering concept. “An electrical or mechanical or electromechanical, programmable or non-programmable multifunctional manipulator designed to move material, parts, tools, or specialized devices through various programmed motions for the performance of a variety of tasks.” Isaac Asimov popularized the term robotics. Asimov is a visionary who envisioned in the 1930's the positron brain for controlling robots. He invented the three laws of robotics: (1) A robot may not harm a human through action or inaction, allow a human to come to harm. (2) A robot must obey the orders given by human beings, except when such orders conflict with the First Law. (3) A robot must protect its own existence as long as it does not conflict with the First or Second Laws. The evolution of robotics research in the last half century as a response to the evolution of human social needs, from the industrial robotics that released the human operator from dangerous or risky tasks to the recent explosion of field and service robotics to assist the human. During the last 45 years, robotics research has been aimed at finding solutions to the technical necessities of applied robotics. Robots were initially used in the automation sector to handle repetitive and simple tasks reliably, with the objective of cost reduction per product. Along with the increased speed of embedded microcontrollers, the service robotic sector has started to grow.

RELATED WORK

Technology invented by author is the use of Medical Robotics in Computer-Integrated Surgery. The problem is being to use which design issues in medical robotics, computer-integrated surgery, surgical CAD/CAM, and surgical assistants.[14]

The solution obtain is to focus on the role of medical robots within the context of their role in CIS systems. The systems into two broad families: surgical

National Conference on Current Trends in Engineering, Science and Technology (NACCTEST- 2018)
Organized by GF's Godavari College of Engineering, Jalgaon
International Journal of Innovations in Engineering and Science, Special Conference Issue, 2018
www.ijies.net

CAD/CAM and surgical assistants. As with industrial robots, the first consideration in design of medical robots is identifying the advantages provided by the robot that would justify its incorporation into a clinical system. These themes are also briefly introduced for each system family.

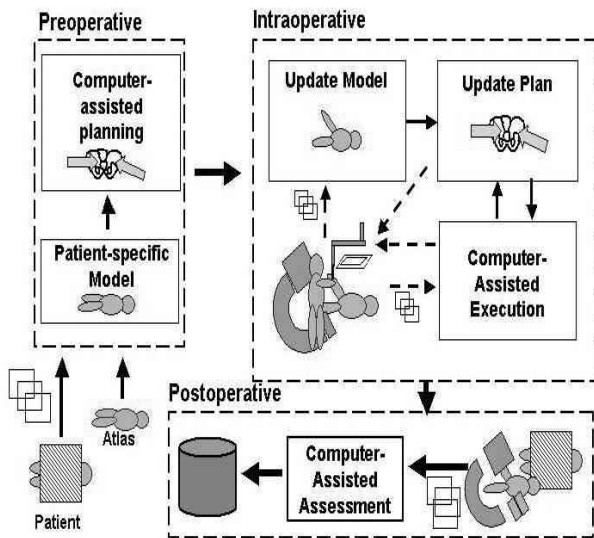

Fig 1. Information flow of CIS systems

In addition to the technical issues inherent in constructing systems that can provide these advantages, one of biggest challenges is finding ways to reduce the setup overhead associated with robotic interventions. A second challenge is to provide a modular family of low-cost robots and therapy delivery devices that can be quickly configured into fully integrated and optimized interventional systems for use with appropriate interventional imaging devices for a broad spectrum of clinical conditions with convenience comparable to current outpatient diagnostic procedures. The goal of surgical robotics is not to replace the surgeon with a robot, but to provide the surgeon with a new set of very versatile tools that extend his or her ability to treat patients.

The Experimental Result is such as (1) Imaging, modeling, and analysis: Advances are needed in techniques for building patient-specific anatomical models from preoperative images and real-time sensor data, for incorporating biomechanical information into these models, and for using this information to help control the robot. Broadly, surgical robots need to become more precise, dexterous, and sensitive, while also becoming much more compact and inexpensive. Robots are surgical tools, not surgeons, and better

surgeon-machine interfaces are needed. No one system will ever meet all needs, and the engineering overhead and certification cost of medical devices is very high. Progress in these areas will most fruitfully be made within the context of systems targeted at well-defined applications or families of application.

The next Technology invented is Real time robotic tactile sensor system for the determination of the physical properties of biomaterials[14].The emerging requirement to build smart robotic manipulation for the next generation of virtual systems, incorporating hand-like-tactile feedback, continues to challenge developers in biomedical instrumentation.

The solution discuss is to satisfy this need to present a novel sensor system, consisting of a combination of a piezoelectric transducer (PZT) and a pressure sensor element. The system is designed with a feedback circuit, made with a disc-shaped PZT sensor element and a phase shift circuit acting as the oscillating circuit. It is suggested that this sensor may prove useful in applications involving robotics in the biomedical field. The new sensor system developed here uses a piezoelectric transducer made of ceramic such as lead zirconate titanate (PZT), a crystal transducer made of polyvinilidene fluoride, or PVDF, can be used as a sensor element.

Principles and structure of tactile sensor-

Fundamental conditions to sense the hardness and/or softness of objects- (1) The sense of touch for detecting hardness below the surface depends on the thickness of overlying soft tissue (it does not depend on the thickness of hard tissue). (2) As the thickness of soft tissue is reduced, the 'felt' hardness increases. (3) The 'felt' hardness for soft tissue depends on the contact pressure applied by the hand 'touching'. This is not the case for hard tissue. (4) The human hand is capable of distinguishing differences in hardness/softness, from soft materials such as rubber to hard materials such as metal, with just one finger. In practical terms, the ability to sense hardness and/or softness of objects is an important enhancement for a robot hand particularly for next generation virtual systems. The experimental results indicate that the tactile sensor, combined with its embedded pressure sensor, can be readily applied to a robot's hand and that the robot will be capable of controlling its gripping power by using the measurement feedback from this sensor.

National Conference on Current Trends in Engineering, Science and Technology (NACCTEST- 2018)
Organized by GF's Godavari College of Engineering, Jalgaon
International Journal of Innovations in Engineering and Science, Special Conference Issue, 2018
www.ijies.net

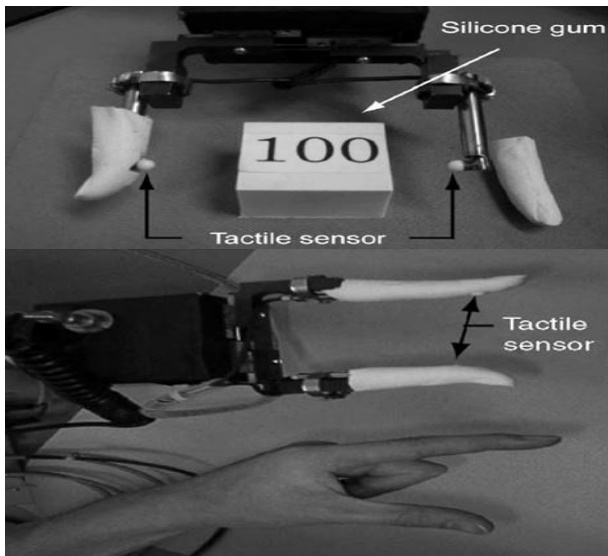

Fig 2 . Tactile sensor

The tactile sensor system presented here, which consists of an embedded PZT transducer, is capable of clearly sensing differences in degrees of hardness and/or softness of different test objects.

In April 2006, The next technology invented is Robotic surgery setup simulation with the integration of inverse-kinematics computation and medical imaging.

The problem regarding to this technology is how to develop a preoperative planning system with the function of volume rendering of medical images and automatic positioning by applying an inverse-kinematics computation of surgical robot, the answer states that in particular, telerobotic and computer-assisted systems are currently making exceptional progress in the field of endoscopic surgery. Two competing systems, the da Vinci system [1] (Intuitive Surgical Inc., CA) and the ZEUS system [2] (originally Computer Motion Inc., CA), have targeted cardiac surgery for their introduction in the surgical field.



Fig 3. US surgery.

Experimental result is (1) Automatic guidance of robotics setup- The initial pose of the surgical robot and the incision site of the robot arm in laparoscopic cholecystectomy have been thoroughly discussed and successfully planned in this developed system.

(2) Optimization of robotics setup- The locations should be judged and decided by surgeons considering the complex clinical conditions.

(3) Integration of DICOM images for clinical use and its evaluation-In clinical use, it is very important to reduce time when routinely acquired DICOM images are imported into the planning system. A simulation system of surgical robot setup for ZEUS surgery has been developed with the function of inverse kinematics computation. This system provides the interface in which surgeons can drag and edit the arms of the virtual Surgical robot in a manner that has consistent kinematics with the real robot.

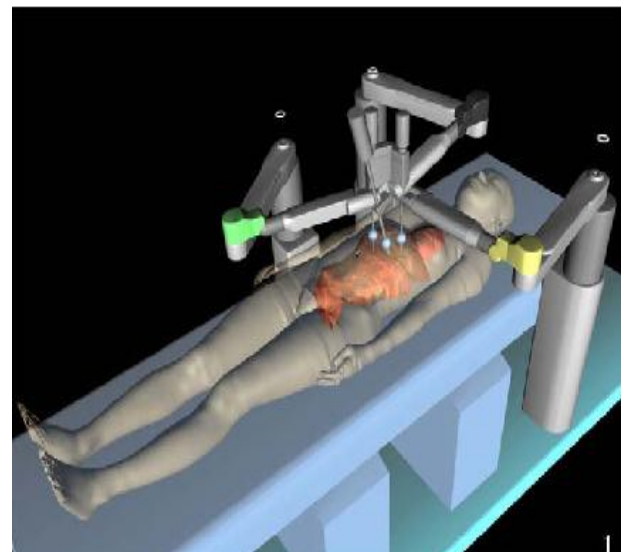

Fig 4. Robotics setup

In September 2006, the Special Issue on Medical Robotics are to modified robot satisfied the rehabilitation robotics, and assistive robotics have been generally considered separate fields, and few researchers cross the boundaries between the various communities in spite of the fact that they often use strikingly similar technologies.

The Solution discuss to takes a broad view of the term “medical robotics”, including not only robotic technologies for surgical planning and execution, but also rehabilitation robotics in which human-robot interaction is used to retrain and restore neuromotor

National Conference on Current Trends in Engineering, Science and Technology (NACCTEST- 2018)
 Organized by GF's Godavari College of Engineering, Jalgaon
International Journal of Innovations in Engineering and Science, Special Conference Issue, 2018
 www.ijies.net

functions, and assistive robotics which aims to assist the elderly and disabled in activities of daily living. This issue on Medical Robotics covers not only applications in robotics surgery, but also in diagnosis, rehabilitation, and assistive devices. Research involving systems using alternative interface approaches is also presented, including electromyographic control using surface electrodes and a system using an indirect interface or "motor substitution." The use of robotics and virtual reality technologies to interact with the human visuomotor system for rehabilitative purposes is then reviewed, including approaches for both upper and lower limbs.

We conclude that commercialization of robotic devices for medical applications is uniquely challenging due to the regulatory approvals that must be obtained.

In MARCH 2007, the next research is on the evolution in robotics from classical motion control for industrial robots to modern intelligent control techniques and social learning paradigms, among other aspects. Research in humanoid robotics is currently shifting from locomotion issues to interaction between humans and robots. Medical robots may be classified in many ways: by manipulator design (e.g., kinematics, actuation); by level of autonomy (e.g., preprogrammed versus teleoperation versus constrained cooperative control); by targeted anatomy or technique (e.g., cardiac, intravascular, percutaneous, laparoscopic, microsurgical); by intended operating environment [e.g., in-scanner, conventional operating room], etc. Maybe the key is that new challenges in manipulation in factories require less research now because factory needs lie in the field of traditional engineering. The new trends in robotics research have been denominated service robotics because of their general goal of getting robots closer to human social needs.[1]

Experimental Result is Engelberger thus gained many detractors, who have rapidly argued back that these kinds of robots are a necessary step in the evolution towards real robots capable of helping disabled persons, performing dangerous work and moving in hazardous places. As the complexity of tasks has increased, flexibility has been demanded in industrial robots, and robotics research has veered towards adaptive and intelligent systems.

In 2008, the Performance evaluation of a medical robotic 3D-ultrasound imaging system.[2]

Problem arise is 3D-US freehand tracking systems are not optimally adapted for the quantification of lower limb arterial stenoses because their performance depends on the scanning length, on Ferro-magnetic interferences or because they require a constant line of sight with the US probe.

Solution over this is Pulsed-wave Doppler ultrasound (US) and color Doppler flow imaging are the most popular non-invasive imaging techniques currently in use to investigate the severity of specific lesions along the lower limb vascular tree. Electromagnetic (EM) tracking measures the magnetic field between a transmitter attached to the US probe and a receiver. Limitations of optical systems are mainly the requirement of a constant line of sight and those of EM sensors are errors induced by metallic object interference and a variable performance depending on the scanning distance. Robotic systems represent a promising approach for stenosis quantification as they simultaneously control and standardize the 3D-US acquisition process for long scanning distances and complex geometries. The robot includes three principal components: the computer workstation, the robotic arm and the US scanning system.

Experimental Result is to SP calibration and precision-The SP calibration resulted to assure an accurate SP calibration and constant precision, the robot arm had to be periodically re-homed. This is due to gradual drift in and out of calibration after long periods for which the robot was not operated.

We Conclude that the prototype medical robot proved to be a suitable tracking device that offers a constant performance and control to acquire 3D positions with a high precision and good position and inter-distance accuracies.

In January-March 2009, The paper on Refining Phylogenetic Trees Given Additional Data: An Algorithm Based on Parsimony Problem: The problem of finding a resolution (refinement) of T that minimizes the parsimony score of the given characters.[3]

Solution: A new algorithm for this problem and show that it is fixed-parameter tractable under more general conditions. One of the most basic methods for Phylogenetic tree reconstruction is maximum parsimony (MP). The local OPR-score problem can be solved as a special instance of the GHS problem.

National Conference on Current Trends in Engineering, Science and Technology (NACCTEST- 2018)
 Organized by GF's Godavari College of Engineering, Jalgaon
International Journal of Innovations in Engineering and Science, Special Conference Issue, 2018
 www.ijies.net

In Sep 2010, The paper on Future Scope of Nanorobotics in Medical Field represents that Problem arise is Robots have taken a great consideration in the medical field. The nano robots have created a revolutionary in the medical.[4]

Solution over this is the first steps towards the construction of NEMS (Nanoelectromechanical systems) by assembling nanometer-scale objects using a Scanning Probe Microscope as a robot. This also describes different motions and mechanisms during the working of the Nanorobots. Our research takes an interdisciplinary approach that combines knowledge of macro robotics and computer science with the chemistry and physics of phenomena at the nanoscale. Nanorobotics is an emerging field that deals with the controlled manipulation of objects with nanometer-scale dimensions. Therefore, Nanorobotics is concerned with interactions with atomic- and molecular-sized objects- and is sometimes called Molecular Robotics. The most elementary of nanomedical devices will be used in the diagnosis of illnesses. The first is that the size of the nanomachine determines the minimum size of the blood vessel that it can traverse. We want to avoid damaging the walls of whatever blood vessel the device is in, we also do not want to block it much, which would either cause a clot to form, or just slow or stop the blood flow. What this means is that the smaller the nanomachine the better.

Experimental Result is like human beings who have a reasonable prospect of living many "normal" lifetimes will learn patience from experience, and will be extremely unlikely to risk those "many lifetimes" for any but the most compelling of reasons. Nanorobotics is the technology of creating machines or robots at or close to the microscopic scale of a nanometer.

We Conclude that Nanomedicine will eliminate virtually all common diseases of the 20th century, virtually all medical pain and suffering, allow extension of human capabilities, especially our mental abilities.

Technology: Robotic surgery setup simulation with the integration of inverse-kinematics computation and medical imaging.

Problem: How to develop a preoperative planning system with the function of volume rendering of medical images and automatic positioning by applying an inverse-kinematics computation of surgical robot?

Solution: In particular, telerobotic and computer-assisted systems are currently making exceptional progress in the field of endoscopic surgery. Two competing systems, the

da Vinci system [1] (Intuitive Surgical Inc., CA) and the ZEUS system [2] (originally Computer Motion Inc., CA), have targeted cardiac surgery for their introduction in the surgical field.

Experimental Result: (1) Automatic guidance of robotics setup- The initial pose of the surgical robot and the incision site of the robot arm in laparoscopic cholecystectomy have been thoroughly discussed and successfully planned in this developed system.

(2) Optimization of robotics setup- The locations should be judged and decided by surgeons considering the complex clinical conditions.

(3) Integration of DICOM images for clinical use and its evaluation-In clinical use, it is very important to reduce time when routinely acquired DICOM images are imported into the planning system.

Conclusion: A simulation system of surgical robot setup for ZEUS surgery has been developed with the function of inversekinematics computation. This system provides the interface in which surgeons can drag and edit the arms of the virtual Surgical robot in a manner that has consistent kinematics with the real robot.

In MAY 2011, The paper on Medical Robotics and Computer-Aided Therapy described the actual need and advantage of navigation, localization, and robotics in surgery and therapy has been in doubt and the availability of better hardware and more sophisticated algorithms has largely increased.[5]

Solution: Information and communication technology (ICT) and mechatronics play a basic role in medical robotics and computer-aided therapy. Computer assisted surgery (CAS) refers to technologies including medical robotics, image guided surgery, computer-integrated advanced orthopedics, stereotactic guidance, and computer-assisted medical interventions. Besides enhancing the accuracy and repeatability, CAS systems improve the surgeon's three-dimensional (3-D) perception of the surgical scenario and support the surgeon's skill in performing highly demanding procedures. The CAS systems can also assist the surgeon in the planning of an operation. In general, applications include neurosurgery; ear, nose, and throat (ENT) surgery; and orthopedics. The computer-aided positioning in hadrontherapy (CAPH) system combines the most modern image-guidance techniques with a highaccuracy positioning device in an automated procedure for real-time setup control.

National Conference on Current Trends in Engineering, Science and Technology (NACCTEST- 2018)
Organized by GF's Godavari College of Engineering, Jalgaon
International Journal of Innovations in Engineering and Science, Special Conference Issue, 2018
www.ijies.net

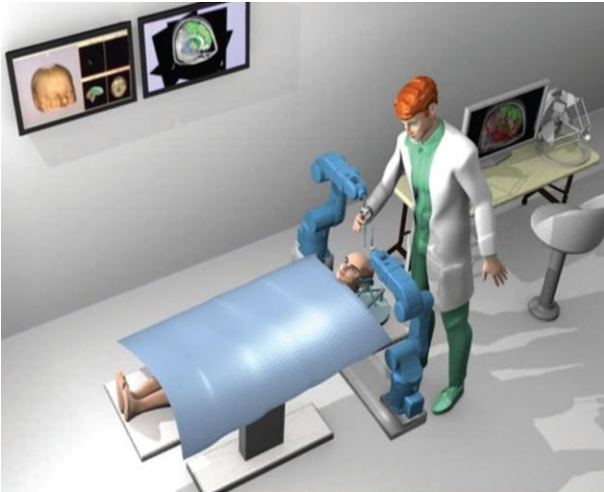

Fig 4. - The ACTIVE concept.

Experimental Result: Robotics, in particular, is exploited in both therapeutic and assistive fields, showing its great potential as an effective personal aid. Given the saturation and marginal cost reduction going on in the automotive market, health care represents one of the potential investments in the fields of service and professional robotics that will boost the research in mechatronics, augmented reality, and intelligence augmentation in the next years.

Conclusion: It is very widely explored at Politecnico di Milano in several departments. Potential benefits, especially for the elderly, are straightforward in the field of robot-based assistive systems, which will allow for a better quality of life (daily life activities and mobility) even for severely disabled patients.

In August 2012 Intention –Based EMG Control for powered Exoskeletons. Problem: The natural ability of human central nervous system of adapting to external disturbances could compensate for a lower accuracy of the torque provided by the robot and accuracy of the torque provided by the robot and maintains the movement accuracy unaltered, while the effort is reduced.[6]

Solution: In order to explore this possibility, the reaction of ten healthy subjects to the assistance provided through a proportional EMG control applied by an elbow powered exoskeleton. This system gives only a rough estimate of the user muscular torque but does not require any specific calibration. Used the NEUROExos powered exoskeleton to apply an assistive controller on single-joint tasks.

CONCLUSION

Although still in its infancy, robotic surgery has already proven itself to be very important, particularly in areas which are not accessible to classical laparoscopic type of procedures. It seems like robotic systems will replace conventional and legacy laparoscopic instruments in less technically demanding procedures. Furthermore, it has the potential to expand surgical treatment modalities beyond the limits of human ability. Whether the benefits of robotics systems overcome the cost to implement it or not, seems it remains to be worked out. Further research must evaluate cost effectiveness or a true benefit over conventional therapy for robotic surgery to take full root. Within the next few years robotic surgery seems to replace most of the conventional surgery, because of the possibility of high precision with robotic surgery is beyond the reach of human hand.

However, many of current advantages in robotic assisted surgery ensure its continued development and expansion. One exciting possibility in improvement is expanding the use of preoperative and intra operative video image fusion to better guide the surgeon in dissection and identifying pathology.

REFERENCES

- [1] Elena Garcia, Maria Antonia Jimenez, Pablo Gonzalez De Santos, And Manuel Armada, The evolution of robotics Research 1070-9932/07/\$25.00© March 2007 IEEE
- [2] Janvier MA, Durand LG, Cardinal MH, Renaud I, Chayer B, Bigras P, de Guise J, Soulez G, Cloutier G. Performance evaluation of a medical robotic 3D-ultrasound imaging system. *Med Image Anal.* 2008 Jun;12(3):275-90. Epub 2007 Nov 1.
- [3] Taoyang wu, Wincent moulton, Mike Steel, Refining Phylogenetic Trees Given Additional Data: An Algorithm Based on Parsimony, **Published in:** IEEE/ACM Transactions on Computational Biology and Bioinformatics, Volume: 6, Issue: 1, Jan.-March 2009.
- [4] Keshav kumar EE Pawan Garg EC, Prince kumar Teli E, Case Study on Future Scope of Nanorobotics in Medical Field, Oct 27th, 2010
- [5] Russell H. Taylor, Arianna Menciassi, Gabor Fichtinger, Paolo Fiorini, Paolo Dario, *Medical Robotics and Computer-Integrated Surgery*, Springer Handbook of Robotics pp 1657-1684, May 2011.
- [6] Tommaso Lenzi, Stefano Marco Maria De Rossi, Nicola Vitiello, Intention –Based EMG Control for powered Exoskeletons, IEEE Transactions on Biomedical Engineering Volume: 59, Issue: 8, Aug. 2012.
- [7] Jessica Burgner, D. Caleb Rucker, Howie Choset, Continuum Robots for Medical Applications: A Survey, IEEE Transactions on Robotics, Volume: 31, Issue: 6, Dec. 2015.
- [8] Hiroyuki NITTO, Daisuke TANIYAMA and Hitomi INAGAKI Social Acceptance and Impact of Robots and Artificial Intelligence, NRI Papers No.211, February 1, 2017.

National Conference on Current Trends in Engineering, Science and Technology (NACCTEST- 2018)
 Organized by GF's Godavari College of Engineering, Jalgaon
International Journal of Innovations in Engineering and Science, Special Conference Issue, 2018
 www.ijies.net

Study Of CAN Bus In Autonomous Of All Terrain Vehicle

Jagruti Wagh¹, R. V. Patil², I. S. Jadhav³, Shafique Ansari⁴, A. D. Vishwakarma⁵

¹ PG Scholar (VLSI & ESD), ^{3,4} Assistant Professor, ^{2,5} Asso. Professor
^{1,2,3,4,5} Dept. Of E&TC Engg, GF's Godavari CoE, Jalgaon, Maharashtra, India. Pin-425001
²rajendravpatil1966@gmail.com

Abstract – The mechanical control system of the all-terrain vehicle (ATV) is converted to an electronic control system and is interfaced to a wireless radio system. In order to improve the control system design and reduce the wiring, a Controller Area Network (CAN) control system has been implemented which is very flexible and reliable. A CAN control system contains electronic control units (ECU) which communicate over CAN protocol. CAN protocol is a serial communication protocol which is internationally standardized by ISO and it creates a two line differential bus for communication. It is a widely used real time communication protocol designed mainly for in vehicle networking but also gained popularity in many embedded applications.

Networked Electronic Control Units (ECUs) are increasingly being deployed in automobiles to realize various functions and Controller Area Network (CAN) is deployed for the communications among ECUs. Our primary objective is to build both hardware and software that interface and communicate directly with CAN network and extract CAN messages for reliable car communications. The hardware is a circuit board that is capable of capturing CAN signals released from an automobile. The software will be both the firm-ware programmed for the two microcontrollers found on the circuit board, as well as the Graphical User Interface on the PC that enables users to control

the functionalities of automobile via a few simple clicks of the buttons.

Keywords – All Terrain Vehicle, CAN, Networked Electronics Control Unit

INTRODUCTION

(ECUs) are increasingly being deployed in automobiles to controls one or more electrical subsystems to realize The recent technology trends in the automobile industry are bringing more safety and comfort in a vehicle by incorporating automation techniques like collision avoidance, air bag deployment and entertainment devices. In the process of making an automated vehicle, there was a rapid increase in the use of electronic control units (ECU) in the vehicle. Therefore, there was a need for a special communication system for achieving the communication between the ECUs in a vehicle. Initially, multiplexed communication was implemented which decreased the interconnections (cables) between the ECUs. The main problem with the multiplexed communication system was it could not communicate data in real time. In 1980's, BOSCH Corporation designed a multi master serial communication protocol called Controller Area Network (CAN) protocol for robust and real time for in-vehicle networking.

In recent years, control systems of cars have moved from the analog to the digital domain. In

National Conference on Current Trends in Engineering, Science and Technology (NACCTEST- 2018)
Organized by GF's Godavari College of Engineering, Jalgaon
International Journal of Innovations in Engineering and Science, Special Conference Issue, 2018
www.ijies.net

particular, x-by-wire systems are appearing and drive research efforts of the whole automotive industry for the recent decade. Electronic Control Units the various functions.

LITERATURE REVIEW

The first vehicle with the CAN protocol was implemented in 1986 and reduced 2km of wiring and 50kgs of weight in the vehicle. Since then, CAN protocol have become the most widely used communication protocol for in-vehicle networks. When a driver drives a car, there are many signals that are passed between the various ECUs embedded inside the car. Output signals from an ECU contain information about the current state of the car as the driver interacts continuously with the car. A modern automobile can consists of up to 70 ECUs [1, 2], sensing and taking tabs of the various parameters of the automobile. This rapid and complex exchange of signals ensures the proper functioning of the car.

After this the problem of real time was solved. The car has number of sensors to control the overall activities. It mainly focuses on the real time analysis of sensor systems, data fusion algorithms and field buses [3]. In a paper titled "Localization of a Mobile Robot using Images of a Moving Target", design of an autonomous robot which tracks a particular object using a CCD camera is discussed. In this design, control of the motor movement for the wheels and camera are acquired over CAN bus [4]. Then after that this system was implemented in a home service robot used for vacuum cleaning and home security is designed. The robot consists 20 of sensors and a USB camera. The sensor data is communicated over CAN bus and for the rest of the data TCP/IP protocol is implemented [5]. In 2005 the main locomotion task is to move a vehicle safely between particular positions in an outdoor environment. The terrain comprises tracks or suitable surfaces on

which the vehicle can travel. [6]. In 2008 the problem of inability to bound the response time messages in real time fashion is solved.[7]. This can be solved by considering two approaches first one is to improve software of CAN application layer and second one is to compensate for time delay.[8] Various disappointments in field experiments have driven us to redesign the position estimation and mapping approach in order to respond to the challenges of generating high fidelity perception on a moving platform.

From the literature review, each CAN node designed carries a different firmware which limits the use of it only to that particular application. Keeping in mind the reusability of the device, a design of an RS232-CAN communication bridge has been implemented. The RS232-CAN communication bridge can be used in any application where a CAN bus needs to be implemented and the devices which give digital data can be programmed to output data on a serial port. The module implementation has been tested as a vehicle network bus for the ATV.

CAN BASICS

2.1 Overview

Controller Area Network (CAN) is an asynchronous serial communication protocol which follows ISO 11898 standards and is widely accepted in automobiles due to its real time performance, reliability and compatibility with wide range of devices. CAN is a two wire differential bus with data rates up to 1Mbps and offers a very high level of security. Its robust, low cost and versatile technology made CAN applicable in other areas of applications where inter processor communication or elimination of excessive wiring is needed. Some of the areas it is widely used are industrial

National Conference on Current Trends in Engineering, Science and Technology (NACCTEST- 2018)
Organized by GF's Godavari College of Engineering, Jalgaon
International Journal of Innovations in Engineering and Science, Special Conference Issue, 2018
www.ijies.net

machinery, avionics, medical equipments and home automation etc.

2.1.1 Characteristics of CAN protocol

The main characteristics of CAN protocol are

- Multi master hierarchy
- Priority based bus access
- Baud rate up to 1Mbits/sec
- Error detection and fault confinement

A CAN bus is a half duplex, two wire differential bus. The two lines, CAN_L and CAN_H, form the communication bus for the nodes to transmit data or information. The logic levels used on the bus are dominant and recessive levels, where dominant level is referred when TTL = 0V and recessive level is referred when TTL = 5V. The dominant level always overrides recessive level and this concept is used to implement the bus arbitration.

In the CAN protocol, nodes communicate data or information through messages termed as frames. A frame is transmitted on to the bus only when the bus is in idle state. There are four different types of frames which are used for communication over CAN bus.

- Data Frame – Used to send data
- Remote Frame – Used to request data
- Error Frame – Used to report an error condition
- Overload Frame – Used to request a delay between two data or remote frames.

The frames transmitted from one node will be received by all the other nodes on the network using message broadcasting. The message filtering which is provided by the CAN controller hardware, decides whether the received frame is relevant to that node or not. If any error occurs due to reception or transmission, an error frame will be transmitted on the bus to let the

network know of the error. Since the error frame starts with a 6 dominant bits, it will have highest priority when the bus is idle. As soon as the error is detected, the CAN protocol implements the fault confinement techniques to overcome the error. The fault confinement feature in the CAN protocol differentiates between a temporary error and a permanent failure of a node. If the error is due to permanent failure of the node, it automatically detaches the defective node from the bus without causing any problems to the network.

2.2 Structure of a node in CAN network

The CAN controller implements only three layer of the ISO/OSI Reference model in a node. It creates a bridge from Data link layer to Application layer (as shown in FIGURE 3.1) in order to limit the resources and to improve the performance. The other layers i.e. Layer 3 to Layer 6 are implemented in higher layer protocols like CAN open. The physical layer and data link layer are integrated on the CAN controller chips and the libraries for the connection between the data link layer and the application layer are provided by the CAN chip manufacturers.

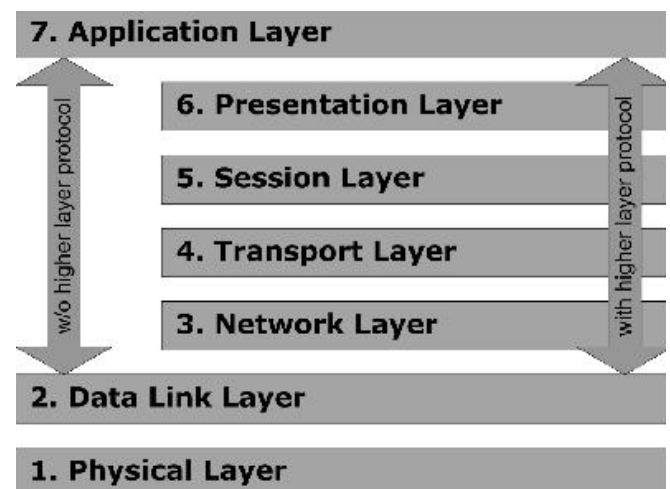

FIGURE 3.1: ISO/OSI Reference model for CAN protocol.

2.3 Types of Frames and their Architectures

As mentioned earlier CAN provides four different types of message frames for communication, the architecture of each frame is discussed as follows.

2.3.1 Data and Remote Frame

The architecture of the data and the remote frame are exactly the same. A data frame has higher priority than a remote frame. Each data and remote frame starts with a Start Of Frame (SOF) field and end with an End Of Frame (EOF) field. The FIGURE 2.2 gives architecture of data and remote frames.

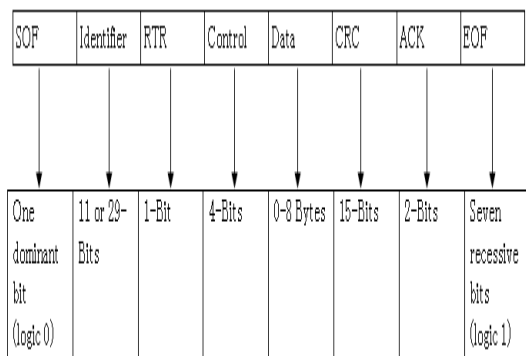

FIGURE 2.2: Architecture of Data and Remote frame.

The following are the fields in data and remote frame:

- SOF field (1 bit) – Indicates the beginning of the frame. A single dominant bit represents a start of a frame. It is also used for data transfer synchronization.
- Arbitration Field – This contains two sub fields, Message Identifier and RTR field.
- Message Identifier (11/29 bits) – This field contains a message ID for each frame which is either 11 (standard ID) or 29 (Extended ID) bits. No two message frames in the CAN network should have the same message ID. A message ID which has a low decimal value is considered as a high priority message.

- Remote Transmission Request (RTR) (1 bit) – The RTR field distinguishes a data frame from a remote frame.

- Control Field (6 bits) – This contains two sub fields, IDE and DLC field

- Identifier Extension (IDE) Bit (1 bit) – This bit indicates the format of the message ID in the frame, either a standard 11-bit format or extended 29-bit format.

- Data Length Code (DLC) field (4 bits) – This field is used to set the amount of data being transferred from one node to other node. In a remote frame, these bits represent the amount of data it is requesting. The following are the values of the DLC bits for the corresponding amount of data.

TABLE 2.1: Setting of DLC field for required amount of data.

DLC (3 bits)	Amount of data
Dddd	0 bytes
Dddr	1 bytes
Ddrd	2 bytes
Ddrr	3 bytes
Drdd	4 bytes
Drdr	5 bytes
Drrd	6 bytes
Drrr	7 bytes
Rddd	8 bytes

Where “r” represents recessive level.
 “d” represents dominant level.

- Data Field – This field contains the actual data and it is not applicable for remote frame.

- CRC field (16 bits) – The CRC field consists of the CRC Sequence and a CRC Delimiter bit.

National Conference on Current Trends in Engineering, Science and Technology (NACCTEST- 2018)
Organized by GF's Godavari College of Engineering, Jalgaon
International Journal of Innovations in Engineering and Science, Special Conference Issue, 2018
www.ijies.net

□ CRC Sequence field (15 bits) – This 15 bit field contains the frame check sequence without the stuffing bits.

□ CRC Delimiter bit (1 bit) – This bit is used to provide processing time for the CRC Sequence field.

□ ACK field (2 bits) – The ACK field consists of a 1 bit Acknowledgement Slot field and Acknowledgement Delimiter bit (which is always recessive).

□ EOF field (7 bits) – Indicates the end of the frame. A seven bit continuous recessive bit represents the end of frame.

A node uses data frame to transmit data to any other node on the network. The RTR field determines whether the message frame should act as data frame or a remote frame. When the RTR bit is set to dominant level, then the message frame will act as a data frame. A maximum of 8 bytes of data can be transferred using a single data frame. Each data frame will be assigned a unique message ID using which the node decides whether the data is relevant or not.

A remote frame is used to request a data frame from any node on the network. When the RTR bit is set to recessive level, then the message frame will act as a remote frame. While requesting data from a node, the length of the data field in control field (DLC bits) of the remote frame should be same as the requesting data frame otherwise a bus collision occurs. As soon as the remote frame is accepted by a node, a data frame will be transmitted on to the bus with the requested data. When two or more nodes on the network request the same message at the same time a bus collision occurs.

2.4 Message Broadcasting

CAN protocol is based on message broadcasting mechanism, in which the frames transmitted from one node is received by every other node on the network. The receiving nodes will only react

to the data that is relevant to them. Messages in CAN are not acknowledged due to unnecessary increase of traffic. But the receiving node checks for the frame consistency and acknowledges the consistency. If the acknowledge is not received from any or all the nodes of the network, the transmitting node posts an error message to the bus. If any of the nodes are unable to decode the transmitted message due to internal malfunction or any other problem, the entire bus will be notified of the error and the node re-transmits the frame. If there is an internal malfunction in a node, that particular node reports an error for each frame it receives. Due to this most bandwidth of the network will be allocated to error frames as they have higher priority (starts with 6 consecutive dominant bits). To overcome this problem the CAN protocol supports a bus off state in a node, in which the node will be detached from the bus if it reports an error for more than a pre defined value. The bus off state of a node is implemented to avoid the breakdown of the network due to a single node. While broadcasting data frames on the bus, each node on the bus receives every data frame transmitted on to the bus. As CAN protocol does not support IDs for the nodes and the receiver does not know the information of the transmitter of the frame, each data frame goes through an acceptance filtering process at the receiving node, which is dependent on the message ID (standard or extended) of the frame. The process of data requesting in CAN protocol is carried out by the remote frame. The RTR bit in a frame decides whether the frame is a remote frame or data frame. When the RTR bit is set to recessive level the frame will act as a remote frame.

When a node is requesting a data frame from another node, the message identifier section (ID bits) and data length section (DLC bits) in the remote frame should be of same value of that in the data frame that is requested otherwise an error will be reported on the bus.

National Conference on Current Trends in Engineering, Science and Technology (NACCTEST- 2018)
Organized by GF's Godavari College of Engineering, Jalgaon
International Journal of Innovations in Engineering and Science, Special Conference Issue, 2018
www.ijies.net

2.5 Data Transfer Synchronization

Each node in the CAN network will have different oscillators running at different frequencies, so to make all the nodes work synchronously while transferring data, the CAN protocol uses the falling edge of the SOF bit (transition from recessive to dominant bus level).

The bit coding used in CAN bus is Non-Return-to-Zero principle in which the bit level remains constant during the entire bit time, which creates a node synchronization problem during the transmission of larger bit blocks of same polarity. To overcome this problem CAN protocol uses bit stuffing mechanism.

2.6 Benefits of using CAN

Controller Area Network is a serial communication protocol which is mainly used for reducing wired interconnections in a vehicle. Some of the benefits in implementing CAN protocol in automobiles are

- Reduced wired interconnections
- Low cost implementation
- Speed, reliability and error resistance
- Worldwide acceptance

CONCLUSION

The approach allows the system to determine whether the planned path (or trajectory) is safely executable by the vehicle and whether or not the surface where the vehicle could move can be travelled on. The consideration of planning as a key function in the system permits work close to the actual behavior of the vehicle and hence to predict and attain a better and safer vehicle response.

However, the identification of ground and vehicle parameters could introduce some errors and render unfeasible trajectories or those, which make the motion of the vehicle dangerous. Another issue is the difference that might exist between the estimated position and the actual position of the vehicle with regard to the terrain model. The use of DGPS together with a high-end inertial navigational unit as part of the positioning system minimizes dead-reckoning errors. The main concern is the degree of uncertainty that exists of the terrain conditions. That is, the model of the ground could differ very much from the actual field conditions, rendering the model unusable. The introduction mentioned that exact identification of certain terrain features like friction and deformation is difficult. This can be addressed by incrementally incorporating during operations some qualitative information on the nature of the regions crossed by the vehicle.

REFERENCES

- [1] Heffernan, D., & Leen, G. (2008, September). *ICT based research at Limerick contributes to automotive 'drive-by-wire' technology.*
- [2] Vasilash, G. S. (2005, May). *Hardware-in-the-loop: assuring performance & quality by combining the real & the virtual. Testing. Automotive Design & Production. Gardner Publications, Inc*

National Conference on Current Trends in Engineering, Science and Technology (NACCTEST- 2018)
Organized by GF's Godavari College of Engineering, Jalgaon
International Journal of Innovations in Engineering and Science, Special Conference Issue, 2018
www.ijies.net

[3] J.A. Gil, A. Pont, G. Benet, F.J. Blanes and M. Martinez, "A CAN Architecture For An Intelligent Mobile Robot," in *Proceedings of the Third IFAC Symposium in Intelligent Components and Instruments for Control Applications (SICICA'97)*, 1997, pp. 65-70.

[4] B. H. Kim, D. K. Roh, Jang M. Lee, M. H. Lee, K. Son, M. C. Lee, J. W. Choi and S.H. Han, "Localization of a Mobile Robot using Images of a Moving Target," in *International Conference on Robotics and Automation, Korea, 2001*, pp. 253-258.

[5] B. You, M. Hwangbo, S. Lee, Sang-Rok Oh, Y. Kwon and San Lim, "Development of a Home Service Robot 'ISAAC'," in *International Conference on Intelligent Robots and Systems, Las Vegas Nevada, 2003*, pp. 2630-2635.

[6] Moëz CHERIF¹, Javier Ibañez-Guzmán², Christian Laugier¹ and Terence Goh³ "Motion planning for an All-Terrain Autonomous Vehicle."

[7] Woonhyuk Baek ,Seyong Jang ,Hoin Song, Soontae Kim Bongsob Song , A CAN-based Distributed Control System for Autonomous All-Terrain-Vehicle(ATV)978-1-1234-7890-2/08/\$20.00 © 2008 IFAC

[8] R. Luck and A. Ray. An observer-based compensator for distributed delays. *Automatic*, volume 26, no. 5, pages 346–352, 2006.

National Conference on Current Trends in Engineering, Science and Technology (NACCTEST- 2018)
Organized by GF's Godavari College of Engineering, Jalgaon
International Journal of Innovations in Engineering and Science, Special Conference Issue, 2018
www.ijies.net

Nano Structured Solar Cell: A Review

Kanchan Mangrulkar¹, H. T. Ingale², S. K. Chaudhari³, V. D. Chaudhari⁴, M. N. Patil⁵

¹ PG Scholar (VLSI & ESD), ^{2,3,4,5} Assistant Professor

^{1,2,4,5} Dept. Of E&TC Engg, GF's Godavari CoE, Jalgaon, Maharashtra, India. Pin-425001.

³ Assistant Professor, E&TC Engg dept., SSGB College of Engineering, Bhusawal, Maharashtra India.

⁴ vinuda_chaudhari@yahoo.co.in

Abstract:- Here, different types of nano-structured solar cells are studied. The solar cell parameters vary with the change of material in the fabrication of solar cell films. The comparative study of various parameters like open-circuit voltage (V_{oc}), short-circuit current density (J_{sc}), fill factor (FF) & power conversion efficiency (η) is presented for different types of nano-structured solar cells. Depending on all the parameters discussed above nm-scale texture based Si solar cell have achieved highest efficiency of 14.9%, J_{sc} 30.49 mA/cm² & FF 73% among all the nanostructured solar cells investigated.

INTRODUCTION

The use of nanotechnology into the photovoltaic films shows special promise to both enhance efficiency and lower total cost. Now days, many nano-structured materials are being investigated for their applications in photovoltaics. Nano-structured layers in thin films offer several important advantages. First, due to multiple reflections, the optical path require for absorption is much larger than the actual film thickness. Second, recombination losses are greatly reduced because light generated electrons & holes need to travel over a shorter path. This results in the absorber layer thickness as thin as 150nm in the thin film solar cells...

LITERATURE SURVEY

Nanostructured solar cells offers several advantages for solar cells including, 1) The ability to exceed a single junction solar cell efficiency by implementing new concepts, 2) It provides larger optical path for light absorption, and 3) Recombination losses are reduced.

The RF magnetron sputtering method allows to deposit hydrogenated nanocrystalline silicon (nc-Si:H) at high rates & low temperature (50⁰C) with high crystalline volume fraction (80-90%) [1]. Using the MIG method, nc-Si:H films were formed, which avoids high temperature processing. It is a low temperature & low cost method for fabrication of nc-Si:H [2]. The metal induced growth (MIG) process is used to develop Si nanostructures & wires in both vertical & lateral directions. In this process, a nanocrystalline Si thin film with a 100nm scale continuous & columnar structures was formed. It forms a novel device to generate photocurrent & give antireflection [3].

To obtain high Voc & high fill factor (FF), the required CdS crystallinity was achieved using novel technology. Also, a 14.8% efficiency of the low environmental -load CdS or CdTe solar cell was achieved [4]. The nc-Si:H films are more stable during light soaking than amorphous Si [5]. The light-soaking degradation of a-Si:H solar cells was overcome using nanostructure tailored Si. Degradation ratio is reduced from 19% to 5%. Also, a light-soaked efficiency of 7.3% was achieved which is more than amorphous solar cell (6.8%) on nanostructured substrate [6].

The use of nanostructures in photovoltaics offers the potential for high efficiency & low fabrication costs, moving to structures or materials which can be fabricated using chemically or biologically formed

National Conference on Current Trends in Engineering, Science and Technology (NACCTEST- 2018)
 Organized by GF's Godavari College of Engineering, Jalgaon
International Journal of Innovations in Engineering and Science, Special Conference Issue, 2018
 www.ijies.net

materials [7]. The two new techniques for enhancing the performance of nanocrystalline silicon solar cells are proposed. The first technique involves the use of superlattice structures of amorphous and nanocrystalline silicon layers & the second design involve the use of high growth temperatures to enhance the grain size. It is shown that by increasing the grain size, good device properties can be attained [8]. In 2008, ZnO, SnO₂, Indium-tin oxide (ITO) nanostructures have been produced on glass substrates coated with a transparent conducting oxide (TCO) electrode for application in dye sensitized solar cells (DSC). Quasi one-dimensional (1D) nanostructures of different TCOs have been synthesized using the vapour transport-and-condensation technique [9].

Nanostructured materials have offered more efficient solar cells using 1-D nanostructures like nanotubes, nanowires & nanorods. The solar cell efficiencies are also improved thereby increasing photon absorption, electron transport, & electron collection. It gives $\eta=1.38\%$, $V_{oc}=0.5V$, $J_{sc}=13.8mA/cm^2$, & $FF=19\%$ [10]. The Si nanowire based solar cells on Si wafers & on multicrystalline Si thin films on glass show strong broadband optical absorption. Under AM1.5 illumination $V_{oc}=0.23-0.28V$, $J_{sc}=2mA/cm^2$, $FF=0.2$ & conversion efficiency = 0.1% were obtained [11]. Si nanowires or Si nanopillars (Si-NP) offers excellent optical & electrical characteristics. The Si-NP textured solar cells have reduced the production cost & high efficiency. It provides $J_{sc}=31.6mA/cm^2$ & power conversion efficiency (PCE) = 18.1% [12]. A 3D nanostructure solar cells are based on CdS nanowires or nanopillars embedded in a CdTe thin film. This structure offers increase in the absorption for a given device thickness. The solar cells under Am1.5G illumination achieved $V_{oc}=0.62V$, $J_{sc}=21mA/cm^2$, $FF=43\%$ & $\eta=6\%$ [13].

A dye-sensitized solar cell (DSSC) is developed by diffusing dye molecules into a mesoporous layer of ZnO or TiO₂ nanorods to form a photoactive surface for photocurrent generation [14]. The nanorod growth occurred in three phases: 1) solution stabilizes and nucleation begins; 2) nanorods linearly grow with time; and 3) growth decline due to depletion of the precursors for crystalline growth or limitation imposed by the randomly orientated surrounding nanorods [15]. Sufficient time period is required for ZnO growth & dye loading to achieve good photo-conversion efficiency. However, extending these two time parameters beyond the optimal reduced the efficiency due to nanorod defects & dye agglomerations [16]. Organic solar cells that use polymers are low-cost with solar conversion efficiency of upto 2.5% [17]. While conventional solar cells gives solar PCE of 10% & most advance but expensive models reach upto 30% efficiency [18]. A nanostructured solar cell based on ZnO nanostructures/poly(P3HT):TiO₂ nanorod hybrid provide direct pathways for efficient charge collection. The use of TiO₂ nanorods causes seven times increase in short circuit current with respect to TiO₂ nanorods. This hybrid structure offers $J_{sc}=2.67mA/cm^2$, $V_{oc}=490mV$, $FF=0.45$, $\eta=0.59\%$ [19]. The semiconductor nanorods can be used to fabricate readily processed & efficient hybrid solar cells together with polymer. By controlling nanorod length, the distance on which electrons are transported through device can be change. For a photovoltaic device fabricated using CdSe nanorods 7nm by 60nm & polymer Poly-3, a $PCF=6.9\%$, $V_{oc}=0.7V$, $FF=0.4$ were obtained under AM 1.5G illumination [20]. The polymer solar cells play important role in developing low cost, large area & mechanically flexible photovoltaic devices [21]. Shao-Sian Li, Yun-Yue Lin, Wei-Fang Su, and Chun-Wei Chen presented two different types of polymer/metal

National Conference on Current Trends in Engineering, Science and Technology (NACCTEST- 2018)
Organized by GF's Godavari College of Engineering, Jalgaon
International Journal of Innovations in Engineering and Science, Special Conference Issue, 2018
www.ijies.net

oxide nanocrystal hybrid solar cells. One is the poly(3-hexylthiophene) (P3HT)/TiO₂ nanorods hybrid bulk heterojunction (BHJ) solar cell and the other is a nanostructured ZnO/P3HT hybrid solar cell. In BHJ hybrid solar cell, an interface area between polymer & nanocrystals is large, but provide poor conducting pathways. In contrast, nanostructured hybrid solar cell provides direct pathways electron transport, but the interface area between polymer & nanocrystals is limited. Fig. 1 shows two different constructions of polymer solar cells.

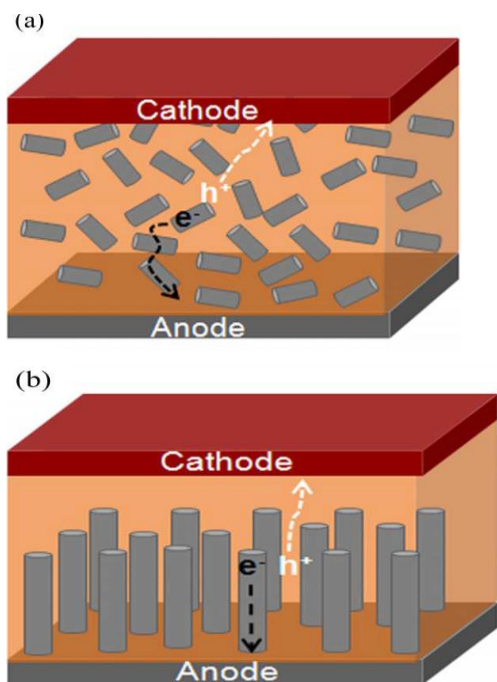

Fig. 1. Demonstration of two different constructions of polymer solar cells.

(a) BHJ solar cell. (b) Nanostructured solar cell. Carrier transport paths were indicated by dashed arrows. Hole transport through polymer phase and electron hop through TiO₂ network pathways in BHJs or directly pass along ZnO nanorods in nanostructured solar cells.

The device fabricated with TiO₂ nanorods modified by the N₃ dye molecule give $J_{sc}=4.33\text{mA/cm}^2$, $V_{oc}=0.78\text{V}$, $FF=0.65$, $\eta=20\%$ performance which is greater than that of performance of devices fabricated using P3HT:TiO₂ nanorods (OA) & P3HT:TiO₂ nanorods (PYR) hybrid material[22].

Also, the performance of device fabricated with ZnO/P3HT & ZnO/(P3HT:TiO₂) hybrid solar cells is mentioned as shown in table below:

TABLE I
DEVICE PERFORMANCE OF ZnO/P3HT AND ZnO/(P3HT/TiO₂) HYBRID SOLAR CELLS BEFORE AND AFTER INTERFACE MODIFICATION

	J_{sc} (mA/cm ²)	V_{oc} (V)	FF (%)	η (%)
ZnO/P3HT	0.30	0.34	40	0.04
ZnO:mer/P3HT	0.87	0.45	41	0.16
ZnO/ (P3HT:TiO ₂)	1.96	0.38	40	0.30
ZnO:mer/ (P3HT:TiO ₂)	2.45	0.46	46	0.52

A dye-sensitized solar cell (DSSC) [23] is developed by diffusing dye molecules into a mesoporous layer of ZnO or TiO₂ nanorods to form a photoactive surface for photocurrent generation. The nanorod growth occurred in three phases: 1) solution stabilizes and nucleation begins; 2) nanorods linearly grow with time; and 3) growth decline due to depletion of the precursors for crystalline growth or limitation imposed by the randomly orientated surrounding nanorods[24]. Sufficient time period is required for ZnO growth & dye loading to achieve good photo-conversion efficiency. However, extending these two parameters beyond the

National Conference on Current Trends in Engineering, Science and Technology (NACCTEST- 2018)
Organized by GF's Godavari College of Engineering, Jalgaon
International Journal of Innovations in Engineering and Science, Special Conference Issue, 2018
www.ijies.net

optimal reduced the efficiency due to nanorod defects & dye agglomerations [25].

The nanocrystalline TiO₂ solar cells sensitized with InAs quantum dots which are relatively efficient and stable are developed. The highest power conversion efficiency of 1.7% under simulated solar illumination AM1.5 5 mW/cm² was achieved which is relatively high for a nanocrystalline metal oxide solar cell sensitized with presynthesized quantum dots, but this efficiency could only be achieved at low light intensity. The drop in solar power conversion efficiency from 1.7% at 5 mW/cm² to 0.3% at 100 mW/cm² is primarily due to the fact that the photocurrent density only increases by a factor of 3.5 as the incident light intensity increases by a factor of 20. Although under 100 mW/cm² illumination, the open-circuit voltage (*V*_{oc}) increased to 0.35 V from 0.29 V under 5 mW/cm², fill factor decreased from 0.58 to 0.48[26]. One-dimensional ZnO nanostructures are favorable for electron collection because the nanostructures provide more direct conduction paths for electrons transport. Besides the electronic conductivity, the morphology of ZnO-nanostructure film plays a very important role in improving dye loading and light harvesting [27]. A cosensitized solar cell with sequentially assembled CdS quantum dots (QDs) and black dye on a flower-like ZnO rod nanostructure was developed by Jing Chen, De Wei Zhao, Wei Lei, and Xiao Wei Sun in 2010. CdS QDs layer acts as a sensitizer as well as it helps to prevent formation of Zn²⁺/dye complex. It also provides intermediate energy levels for excited electron transfer from black dye to ZnO film. A power conversion efficiency as high as 3.26% was achieved for CdSQD and black dye cosensitized ZnO photoanode under AM1.5G illumination of one Sun. The *J*_{sc} and *V*_{oc} of ZnO/CdS, ZnO/black dye, and ZnO/CdS/black dye samples are 6.03, 2.99, and 12.73 mA/cm², and 0.542, 0.414, and

0.607 V, respectively. The FF and PCE of ZnO/CdS/black dye (43% and 3.26%, respectively) are higher than those of ZnO/CdS (34.4% and 1.12%, respectively) and ZnO/black dye (31.3% and 0.40%, respectively)[28].

A critical aspect of organic and inorganic thin film solar cells is the current conduction across the illuminated side of the device in the transparent conductor

(TC). The conventional anode used for organic solar cells was indium tin oxide (ITO). However, high quality ITO is expensive, contains indium that might be too limited in supply for use in solar energy applications. Michael W. Rowell, Mark A. Topinka and Michael D. McGehee fabricated flexible transparent conducting electrodes by printing films of single-walled carbon nanotube (SWNT) networks on plastic and have demonstrated their use as transparent electrodes for bulk-heterojunction solar cells. These devices achieved efficiency of 2.5% under AM1.5 G illumination which is close to efficiency of devices made with ITO/glass [29].

The high transparency metal electrodes are fabricated by nanoimprint lithography (NIL) and have some advantages over highly transparent electrodes including ITO. A high electrical conductivity can be achieved without seriously compromising the transparency. Also, the light absorption and the PCE of OSCs can be increased by means of light trapping phenomena that are induced by the grating structure & large area OSCs with transparent metal electrodes could be fabricated at low – cost[31]. Transparent electrodes based on metallic nanostructure are a strong candidate as a replacement of conventional ITO electrode. They have high optical transparency and good electrical conductivity. About 35% enhancement of PCE was achieved for the OSC using transparent Ag nanowire electrode as compared with the device using conventional ITO electrode [32]. A

National Conference on Current Trends in Engineering, Science and Technology (NACCTEST- 2018)
Organized by GF's Godavari College of Engineering, Jalgaon
International Journal of Innovations in Engineering and Science, Special Conference Issue, 2018
www.ijies.net

a-Si:H nanowires (NWs) and nanocones (NCs) are fabricated using an easily scalable and IC-compatible process.

Using the standard shallow trench isolation process in the CMOS technology nm-scale textured structure on the Si-phonic devices is fabricated. The nm-scale trench structure on the top surface can help to collect more minority carrier, enhance the light trapping effect, reduce the reflectivity of the cells, & finally result in the larger optic-electric transformation efficiency. As compared to the plane surface device, the reflectivity of the nanoscale textured device can be reduced upto 22% from ~30% to 8%. Here, the lower reflectance is due to the much light trapping. Also, the lower reflectance on the device surface & larger n-p junction area can improve both J_{sc} & V_{oc} & in turn result in higher final solar cell efficiency. The parameters for nm-scale texture (plane) solar cell are $V_{oc}=0.66(0.61)V$, $J_{sc}=30.89(28.7)mA$, $FF=0.73(0.7)$ & final efficiency $\eta=14.9(12)\%$ under the illumination of AM1.5 exposure[33].

Under AM1.5G illumination, the solar cell with standard process has a conversion efficiency of 3.1%, $FF=58\%$, $J_{sc}= 2.86mA/cm^2$ & $V_{oc}=1.87V$. Two dimensional polystyrene nanospheres were deposited & self organized as a mask to form a biomimetic surface roughing texture to further improve the conversion efficiency of the GaN/ $In_{0.11}Ga_{0.89}N$ solar cell. Using biomimetic surface antireflection texture increase of 15% in J_{sc} is found, thus improving the conversion efficiency upto 3.87%. The $V_{oc}=1.87V$, $J_{sc}=3.29mA/cm^2$, $FF=62.38\%$, $\eta=3.87\%$ is achieved [35].

Plasmonic photovoltaic is a very promising technology for improving solar cell efficiency & reducing its thickness [37]. A plasmonic nanostructure design with a double layered triangular grating (DTLG)

is is designed. Such a DTLG structure offers enhancement in J_{sc} upto 76.8% at 5 degrees, under AM1.5 illumination. The DTLG structure provides advantages of both the surface Plasmon coupling & wavelength antireflecting. This structure is an important way toward the high efficiency plasmonic photovoltaics [43].

The flat gallium arsenide based solar cell modifies the flow of light & enhance the absorption without modifying the active material structure or degrading its electrical properties. As the coupling element is lossless, it has the advantage that no energy is lost within the dielectric nanospheres. This stored energy is absorbed by the active material due to which there is improvement in solar cell photocurrent. This gives enhancement of 2% compared with a flat solar cell with double antireflection coating. The increase in J_{sc} from $J_{sc}=27.90mA/cm^2$ to $J_{sc}=28.13mA/cm^2$ is found for a hexagonally closed packed array of nanospheres [44].

The nc-Si:H has become a promising candidate to replace hydrogenated amorphous SiGe (a-SiGe:H) alloy in multijunction thin film solar cells because of its superior long -wavelength response & stability against light induced degradation. A a-Si:H/nc-Si:H/nc-Si:H triple junction solar cells fabricated by high frequency (HF) deposition process have attained high efficiency. The initial aperture area of 11.8% on an $807.8cm^2$ encapsulated area & stable aperture area efficiency of 11.2% on a $400cm^2$ encapsulated area has confirmed by National Renewable Energy Laboratory(NREL) for this triple junction solar cell[47]. In order to achieve a high efficiency it is necessary to first optimize the performance of the component a-Si:H & nc-Si:H cells at the high deposition rate for a triple junction solar cell. A triple junction solar cell developed using a HF-excitation process for the deposition of high quality a-Si:H & nc-Si:H films at a

National Conference on Current Trends in Engineering, Science and Technology (NACCTEST- 2018)
Organized by GF's Godavari College of Engineering, Jalgaon
International Journal of Innovations in Engineering and Science, Special Conference Issue, 2018
www.ijies.net

high rate. This solar cell have attained stable aperture-area efficiency of 11.99-12.41% on $\sim 1.0\text{cm}^2$ cells & initial aperture-area efficiency of 12.33% on encapsulated large area that is 400cm^2 cells[48].

CONCLUSION

The nano-structured solar cells offer high efficiency & low cost solar cells. In this study, different types of solar cells fabricated using different processes are studied & the comparative study between various parameters such as short circuit current density(J_{sc}), open circuit voltage(V_{oc}), fill factor(FF) & power conversion efficiency(η) is presented. Considering all the parameters, the nanostructures silicon solar cell offers the high efficiency about 14.9%. It has also achieved higher $J_{sc}=30.89\text{mA}/\text{cm}^2$, better $V_{oc}=0.66\text{V}$, & FF=73% which is due to larger collected minority carriers, better surface quality & lower surface reflectivity.

REFERENCES

1. C. Goncalves, S. Charvet, A. Zeinert, M. Clin, and K. Zellama, "Nanocrystalline silicon thin films prepared by radiofrequency magnetron sputtering," *Thin Solid Films*, vol. 403–404, pp. 91–96, Feb.2002.
2. Ji, C. ; Gulians, E.A. ; Anderson, W.A., "Silicon nanostructures by metal induced growth (MIG) for solar cell emitters", *Photovoltaic Specialists Conference, 2002. Conference Record of the Twenty-Ninth IEEE ,Digital Object Identifier: 10.1109/PVSC.2002.1190851 ,Publication Year: 2002 , Page(s): 1314 – 1317.*
3. Chunhai Ji and Wayne A. Anderson, Senior Member, IEEE," Metal-Induced Grown Si Nanostructures for Large-Area-Device Applications", *IEEE TRANSACTION ON ELECTRON DEVICES, VOL. 50, NO. 9, SEPTEMBER 2003 .*
4. Toyama, T. ; Oda, H. ; Matsune, K. ; Okamoto, H., "Evaluation of CdS nanostructures for application to low environmental-load CdS/CdTe solar cells ",*Photovoltaic Energy Conversion, 2003. Proceedings of 3rd World Conference on Volume: 1 ,Publication Year: 2003 , Page(s): 511 - 514 Vol.1*
5. C.Goncalves, S.Charvet, A.Zeinert, M.Clin, K.Zellama*, " Nanocrystalline silicon thin films prepared by radiofrequency magnetron sputtering", *Thin Solid Films 403 –404 (2002) 91–96.*
6. Ito, M. ; Myojin, N. ; Kondo, M. ; Matsuda, A. ; Shiratani, M. ;Watanabe, Y., "Light-soaking stability of nano-structure tailored silicon thin film solar cells" *Photovoltaic Energy Conversion, 2003. Proceedings of 3rd World Conference on Volume: 2,Publication Year: 2003 , Page(s): 1592 - 1595 Vol.2*
7. Honsberg, C.B. ; Barnett, Allen M. ; Kirkpatrick, D., "Nanostructured Solar Cells for High Efficiency Photovoltaics", *Photovoltaic Energy Conversion, Conference Record of the 2006 IEEE 4th World Conference on Volume: 2 Doi: 10.1109/WCPEC.2006.279769 ,Publication Year: 2006 , Page(s): 2565 - 2568*
8. Madhavan, A. ; Dalal, V.L. ; Noack, M.A., "Superlattice structures for nanocrystalline silicon solar cells", *Electro/Information Technology, 2008. EIT 2008. IEEE International Conference Digital Object Identifier: 10.1109/EIT.2008.4554333 ,Publication Year: 2008 , Page(s): 383 – 388*

National Conference on Current Trends in Engineering, Science and Technology (NACCTEST- 2018)
 Organized by GF's Godavari College of Engineering, Jalgaon
International Journal of Innovations in Engineering and Science, Special Conference Issue, 2018
 www.ijies.net

9. Sberveglieri, G. ; Comini, E. ; Faglia, G. ; Ferroni, M. ; Jimenez, G. ; Vomiero, A., "Preparation of transparent conducting oxide nanostructures for dye-sensitized solar cells", *Photovoltaic Specialists Conference, 2008. PVSC '08. 33rd IEEE* Doi: 10.1109/PVSC.2008.4922816 , Publication Year: 2008 , Page(s): 1 – 3
10. Kehan Yu & Junhong Chen, "Enhancing Solar Cell Efficiencies through 1-D Nanostructures", *Nanoscale Res Lett* (2009) 4:1–10, DOI 10.1007/s11671-008-9200-y
11. Th Stelzner¹, M Pietsch¹, G Andr¹a¹, F Falk¹, E Ose¹ and Christiansen^{1,2}, "Silicon nanowire-based solar cells", *Nanotechnology* 19 (2008) 295203 (4pp) doi:10.1088/0957-4484/19/29/295203
12. S. M. Wong, H. Y. Yu, J. S. Li, G. Zhang, Patrick G. Q. Lo, and D. L. Kwong , "Design High-Efficiency Si Nanopillar-Array-Textured Thin-Film Solar Cell", *IEEE ELECTRON DEVICE LETTERS*, VOL. 31, NO. 4, pp.335-337, APRIL 2010.
13. A 3D nanostructure for improved solar-cell efficiency, *SPIE*, DOI: 10.1117/2.1201002.002606, year:2011.
14. B. O'Regan and M. Grätzel, "A low-cost, high-efficiency solar cell based on dye-sensitized colloidal TiO₂ films," *Nature*, vol. 353, no. 6346, pp. 737–740, Oct. 24, 1991.
15. J. B. Baxter, A. M. Walker, K. van Ommering, and E. S. Aydil, "Synthesis and characterization of ZnO nanowires and their integration into dyesensitized solar cells," *Nanotechnology*, vol. 17, no. 11, pp. S304–S312, May 2006.
16. Szu Cheng Lai, Ming Fei Yang, Surani Bin Dolmanan, Lin Ke, and Xiao Wei Sun, Senior Member, IEEE, "Efficiency Optimization on Dye-Sensitized Solar Cells With Low-Frequency Noise Analysis", *IEEE TRANSACTIONS ON ELECTRON DEVICES*, VOL. 57, NO. 9, SEPTEMBER 2010
17. S. E. Shaheen et al., *Appl. Phys. Lett.* **78**, 841 (2001).
18. M. A. Green, K. Emery, D. L. King, S. Igari, W. Warta, *Prog. Photovoltaics* , 287 (2001).
19. Y. Y. Lin, C. W. Chen, T. H. Chu, W. F. Su, C. C. Lin, C. H. Ku, J. J. Wu, and C. H. Chen, "Nanostructured metal oxide/conjugated polymer hybrid solar cells by low temperature solution processes," *J. Mater. Chem.*, vol. 17, pp. 4571–4576, 2007.
20. W. U. Huynh, J. J. Dittmer, and A. P. Alivisatos, "Hybrid nanorod-polymer solar cells," *Science*, vol. 295, pp. 2425–2427, 2010.
21. W. Ma, C. Yang, X. Gong, K. Lee, and A. J. Heeger, "Thermally stable, efficient polymer solar cells with nanoscale control of the interpenetrating network morphology," *Adv. Funct. Mater.*, vol. 15, pp. 1617–1622, 2005.
22. Shao-Sian Li, Yun-Yue Lin, Wei-Fang Su, and Chun-Wei Chen, "Polymer/Metal Oxide Nanocrystals Hybrid Solar Cells", *IEEE JOURNAL OF SELECTED TOPICS IN QUANTUM ELECTRONICS*, VOL. 16, NO. 6, pp.1635-1640, NOVEMBER/DECEMBER 2010.
23. B. O'Regan and M. Grätzel, "A low-cost, high-efficiency solar cell based on dye-sensitized colloidal TiO₂ films," *Nature*, vol. 353, no. 6346, pp. 737–740, Oct. 24, 1991.
24. J. B. Baxter, A. M. Walker, K. van Ommering, and E. S. Aydil, "Synthesis and

National Conference on Current Trends in Engineering, Science and Technology (NACCTEST- 2018)
 Organized by GF's Godavari College of Engineering, Jalgaon
International Journal of Innovations in Engineering and Science, Special Conference Issue, 2018
 www.ijies.net

- characterization of ZnO nanowires and their integration into dyesensitized solar cells," *Nanotechnology*, vol. 17, no. 11, pp. S304–S312, May 2006.
25. Szu Cheng Lai, Ming Fei Yang, Surani Bin Dolmanan, Lin Ke, and Xiao Wei Sun, Senior Member, IEEE, "Efficiency Optimization on Dye-Sensitized Solar Cells With Low-Frequency Noise Analysis", *IEEE TRANSACTIONS ON ELECTRON DEVICES*, VOL. 57, NO. 9, 2010.
 26. P. R. Yu, K. Zhu, A. G. Norman, S. Ferrere, A. J. Frank, and A. J. Nozik, "Nanocrystalline TiO₂ solar cells sensitized with InAs quantum dots," *J. Phys. Chem. B*, vol. 110, pp. 25451–25454, Dec. 2006.
 27. C.Y. Jiang, X.W. Sun, G.Q. Lo, D.L. Kwong and J. W. Wang, *Appl. Phys. Lett.*, 90, 263501, 2007.
 28. Jing Chen, De Wei Zhao, Wei Lei, and Xiao Wei Sun Senior Member, IEEE, "Cosensitized Solar Cells Based on a Flower-Like ZnO Nanorod Structure", *IEEE JOURNAL OF SELECTED TOPICS IN QUANTUM ELECTRONICS*, VOL. 16, NO. 6, pp. 1607-1610, NOVEMBER/DECEMBER 2010.
 29. M. W. Rowell, M. A. Topinka, M. D. McGehee, H.-J. Prall, G. Dennler, N. S. Sariciftci, L. Hu, and G. Gruner, "Organic solar cells with carbon nanotube network electrodes," *Appl. Phys. Lett.*, vol. 88, pp. 233506-1–233506-3, 2006.
 30. J.-Y. Lee, S. T. Connor, Y. Cui, and P. Peumans, "Solution-processed metal nanowire mesh transparent electrodes," *Nano Lett.*, vol. 8, pp. 689–692, 2008.
 31. M.-G. Kang, M.-S. Kim, J. Kim, and L. J. Guo, "Organic solar cells using nanoimprinted transparent metal electrodes," *Adv. Mater.*, vol. 20, pp. 4408–4413, 2008.
 32. Myung-Gyu Kang, Hui Joon Park, Se Hyun Ahn, Ting Xu, and L. Jay Guo, "Toward Low-Cost, High-Efficiency, and Scalable Organic Solar Cells with Transparent Metal Electrode and Improved Domain Morphology", *IEEE JOURNAL OF SELECTED TOPICS IN QUANTUM ELECTRONICS*, VOL. 16, NO. 6, NOVEMBER/DECEMBER 2010.
 33. Ming Han Liao, "High-Efficient Si Nanotextured Light-Emitting Diodes and Solar Cells With Obvious Photonic Crystal Effect", *IEEE TRANSACTIONS ON NANOTECHNOLOGY*, VOL. 10, NO. 4, pp. 774-777, JULY 2011.
 34. L. Zeng, Y. Yi, C. Hong, J. Liu, N. Feng, X. Duan, L. C. Limerling, and B. A. Alamariu, "High efficient Si nano-textured light emitting diodes and solar cell," *Appl. Phys. Lett.*, vol. 89, pp. 111111–111114, 2006.
 35. H. W. Wang, H. C. Chen, Y. A. Chang, C. C. Lin, H. W. Han, M. A. Tsai, H. C. Kuo, Senior Member, IEEE, P. Yu, Member, IEEE, and S. H. Lin, "Conversion Efficiency Enhancement of GaN/In Ga N Solar Cells With NanoPatterned Sapphire and Biomimetic Surface Antireflection Process", *IEEE PHOTONICS TECHNOLOGY LETTERS*, VOL. 23, NO. 18, pp. 1304-1306, SEPTEMBER 15, 2011.
 36. M. A. Tsai, P. C. Tseng, H. C. Chen, H. C. Kuo, and P. Yu, "Enhanced conversion efficiency of

National Conference on Current Trends in Engineering, Science and Technology (NACCTEST- 2018)
 Organized by GF's Godavari College of Engineering, Jalgaon
International Journal of Innovations in Engineering and Science, Special Conference Issue, 2018
 www.ijies.net

- a crystalline silicon solar cell with frustum nanorod arrays," *Opt. Express*, vol. 19, pp. A28–A34, 2011.
37. H. A. Atwater and A. Polman, "Plasmonics for improved photovoltaic devices" ,*Nat. Mater.*, vol. 9, no. 3, pp. 205–213, Mar. 2010.
38. C. Hagglund, M. Zach, and B. Kasemo, "Enhanced charge carrier generation in dye sensitized solar cells by nanoparticle plasmons" ,*Appl. Phys. Lett.*, vol. 92, no. 1, p. 013 113, Jan. 2008.
39. S. Tsai, M. Ballarotto, D. B. Romero, W. N. Herman, H. Kan, and R. J. Phaneuf, "Effect of gold nanopillar arrays on the absorption spectrum of a bulk heterojunction organic solar cell" ,*Opt. Exp.*, vol. 18, no. Supplement 4, pp. A528–A535, Nov. 2010.
40. M. Kang, T. Xu, H. J. Park, X. Luo, and L. J. Guo, "Efficiency enhancement of organic solar cells using transparent plasmonic Ag nanowire electrodes" ,*Adv. Mater.*, vol. 22, no. 39, pp. 4378–4383, Oct. 2010.
41. Z. Fan, H. Razavi, J. Do, A. Moriwaki, O. Ergen, Y. Chueh, P. Leu, J. Ho, T. Takahashi, L. Reichertz, S. Neale, K. Yu, M. Wu, J. Ager, and A. Javey, "Three-dimensional nanopillar-array photovoltaics on low-cost and flexible substrates" ,*Nat. Mater.*, vol. 8, no. 8, pp. 648–653, Aug. 2009.
42. N. Fahim, Z. Ouyang, Y. Zhang, B. Jia, Z. Shi, and M. Gu, "Efficiency enhancement of screen-printed multicrystalline silicon solar cells by integrating gold nanoparticles via a dip coating process" ,*Opt. Mater. Exp.*, vol. 2, no. 2, pp. 190–204, Feb. 2012.
43. Yaohui Zhan, Jiupeng Zhao, Changhai Zhou, Xianjie Wang, Yanpeng Li, and Yao Li
 , "Surface-Plasma-Coupled Photovoltaic Cell With Double-Layered Triangular Grating " ,*IEEE Photonics Journal* , DOI: 10.1109/JPHOT.2012.2202221 , page no.1943-0655, year-2012 .
44. Jonathan Grandidier, Member, IEEE, Dennis M. Callahan, Jeremy N. Munday, Member, IEEE, and Harry A. Atwater , "Gallium Arsenide Solar Cell Absorption Enhancement Using Whispering Gallery Modes of Dielectric Nanospheres" , *IEEE JOURNAL OF PHOTOVOLTAICS*, VOL. 2, NO. 2, APRIL 2012.
45. J. Zhu, C.-M. Hsu, Z. Yu, S. Fan, and Y. Cui, "Nanodome solar cells with efficient light management and self-cleaning," *Nano Lett.*, vol. 10, pp. 1979–1984, 2010.
46. K. Nakayama, K. Tanabe, and H. A. Atwater, "Plasmonic nanoparticle enhanced light absorption in GaAs solar cells," *Appl. Phys. Lett.*, vol. 93, pp. 121904-1–121904-3, 2008.
47. Arindam Banerjee, Frank Shengzhong Liu, Dave Beglau, Tining Su, Ginger Pietka, Jeff Yang, and Subhendu Guha, "12.0% Efficiency on Large-Area, Encapsulated, Multijunction nc-Si:H-Based Solar Cells" ,*IEEE JOURNAL OF PHOTOVOLTAICS*, VOL. 2, NO. 2, PAGE No.104-108, APRIL 2012.
48. Banerjee A, Su T, Beglau D, Pietka G, Liu F, DeMaggio G, Almutawalli S, Yan B, Yue G, Yang J, Guha S. High efficiency, multi-junction nc-Si:h based solar cells at high deposition rate. 37th IEEE PVSC, Seattle, June 2011.

National Conference on Current Trends in Engineering, Science and Technology (NACCTEST- 2018)
 Organized by GF's Godavari College of Engineering, Jalgaon
International Journal of Innovations in Engineering and Science, Special Conference Issue, 2018
 www.ijies.net

Comprehensive Survey on Thermal Challenges In Electronics Circuits

Jyoti Sapkale¹, Vijay D. Chaudhari², Hemraj V. Dhande³, Mahesh N. Patil⁴

¹ PG Scholar, ^{2,4} Assistant Professor, ³ Asso. Professor
^{1,2,3,4} Dept. Of E&TC Engg, GF's Godavari College of Engineering, Jalgaon, Maharashtra, India. Pin-425001
²vinuda_chaudhari@yahoo.co.in

Abstract – Electronic devices and their applications have been among the fastest advancing fields, with the characteristic dimensions of devices shrinking past the micro scale and into the nanoscale within the matter of just two decades. Today, many modern electronic devices operate with critical dimensions in the tens of nanometers. Moreover, minimum feature sizes of 14 nm and below are being targeted for next-generation technology nodes. At the same time, new approaches at the die and package integration levels such as many-core architectures and three-dimensional (3D) chip stacking are emerging as potential means of increasing computing performance without relying on reduced feature scaling alone. In addition, the rise of mobile devices and touch screen applications has driven new research and development efforts into devices and materials compatible with transparent and/or flexible substrate design requirements. However, these exciting technological advances and emerging applications are also creating thermal challenges that may serve to ultimately limit their effectiveness, scope of implementation, or overall feasibility. During a power amplifier design phase, an important item for a designer to consider is the management of performance over temperature. One of the main parameters that affect performance is the quiescent current. The challenge for designer is to maintain constant quiescent current over a large temperature range. The problem becomes more challenging in a multistage IC (integrated circuit). To overcome this difficulty, Free scale has embedded a quiescent current thermal tracking circuit in its recently introduced family of RF power integrated circuits.

INTRODUCTION

Over the past half-century, the drive for faster, cheaper computing and its long-associated requirements of increasing device density and progressive device miniaturization have served to push scientists and engineers to continually develop new and ever-improving materials, tools, processes, and design methodologies. As a result, electronic devices and their applications have been among the fastest advancing fields, with the characteristic dimensions of devices shrinking past the micro scale and into the nanoscale within the matter of just two decades. Today, many modern electronic devices operate with critical dimensions in the tens of nanometers. Moreover, minimum feature sizes of 14 nm and below are being targeted for next-generation technology nodes.

At the same time, new approaches at the die and package integration levels such as many-core architectures and three-dimensional (3D) chip stacking are emerging as potential means of increasing computing performance without relying on reduced feature scaling alone. In addition, the rise of mobile devices and touch screen applications has driven new research and development efforts into devices and materials compatible with transparent and/or flexible substrate design requirements. However, these exciting technological advances and emerging applications are also creating thermal challenges that may serve to ultimately limit their effectiveness, scope of implementation, or overall feasibility. During a power amplifier design phase, an important item for a designer to consider is the management of performance over temperature. One of the main parameters that affect performance is the quiescent current. The challenge for designer is to maintain constant quiescent current over a large

National Conference on Current Trends in Engineering, Science and Technology (NACCTEST- 2018)
 Organized by GF's Godavari College of Engineering, Jalgaon
International Journal of Innovations in Engineering and Science, Special Conference Issue, 2018
 www.ijies.net

temperature range. The problem becomes more challenging in a multistage IC (integrated circuit). To overcome this difficulty, Free scale has embedded a quiescent current thermal tracking circuit in its recently introduced family of RF power integrated circuits.

LITERATURE SURVEY

In the method of packaging [1] Organic packaging substrates are still dominant in the worldwide market not only for high performance and cost performance applications but also stacked memory applications. Since increasing signal transmitting speed and decreasing operating voltage, packaging substrate requires higher density of circuits with thinner materials to assure signal integrity. It is quite difficult challenges not only for packaging substrate manufacturers but also materials suppliers to assure required electrical performance such as signal integrity and power integrity together with mechanical strength and thermal management. In addition, current organic packaging substrate technology approaching to fabrication technology limit in terms of manufacturing process, base materials, test and engineering staff. In addition to achieve sub-10 microns wiring production, capital investment requires more than 500 million US\$. The two technological directions of substrates for advanced electronic packages will be mapped out: miniaturization and functional integration, and explained in terms of 'More Moore' and 'More than Moore', respectively.

In the method of Power electronic packaging [2] is one of the fastest changing areas of technology in the power electronic industry due to the rapid advances in power integrated circuit (IC) fabrication and the demands of a growing market in almost all areas of power electronic application such as portable electronics, consumer electronics, home electronics, computing electronics, automotive, railway and high/strong power industry. However, due to the intrinsic high power dissipation, the performance requirement for power products is extremely high, especially in handling harsh thermal and electrical environments. The design rules and material and structure layout of power packaging are quite different from regular IC packaging. This talk will present a state-of-art and in-depth overview of recent advances, challenges and opportunities in power electronic packaging design and modeling. A review of recent advances in power electronic packaging is

presented based on the development of power device integration.

RF power to increasing demand for electronic transistor [3] with the cut-off frequency 100 GHz devices capable of function at high power and have been demonstrated this year. frequency levels, high temperatures, and harsh In order to take the full advantage of their environment is one of the most significant issue superior inherent properties several challenges of modern information society, especially in the in material processing are to be overcome. One field of RF systems for telecommunication and of the most important issue is the quality of wireless communication. Moreover, energy metal-semiconductor contacts. This is problems and environmental concerns due to especially true for both, for Schottky barriers global warming have generated the need for to be used in Schottky rectifiers and for holmic novel semiconductor devices for active contacts being a part of any semiconductor electrical power management in areas such as device.

In this method of 3D ICs integrated micro channel liquid-cooling technology is envisioned as a viable solution to alleviate an increasing thermal stress imposed by 3-D stacked ICs. Thermal modeling for micro channel cooling is challenging due to its complicated thermal-wake effect, a localized temperature wake phenomenon downstream of a heated source in the flow. This paper presents a fast and accurate thermal-wake aware thermal model for integrated micro channel 3-D ICs. A combination of the micro channel thermal-wake function and the channel merging technique achieves more than 3300× speedup with less than 5% error in comparison with a commercial numerical finite volume simulation tool. With the proposed model, we characterize thermal behaviors of micro channel-cooled 3-D ICs and compare them with the case of conventional air-cooled 3-D ICs. We also demonstrate thermal-aware placements using our thermal model. It shows that the proposed model can be used to reduce peak temperatures, which is considered important for 3-D IC designs. [4]

In the RTP application the CMOS Technology [5] as device dimensions have reduced to nanometer length scales, rapid thermal processing (RTP) has emerged as the key approach for providing the low thermal budget

National Conference on Current Trends in Engineering, Science and Technology (NACCTEST- 2018)
 Organized by GF's Godavari College of Engineering, Jalgaon
International Journal of Innovations in Engineering and Science, Special Conference Issue, 2018
 www.ijies.net

and ultra-pure process conditions that are essential in advanced fabrication schemes. As further progress in electronic technology becomes increasingly dependent on success in rapid development cycles that include both materials innovations and changes in CMOS device architecture, RTP will play a major role in the story. RTP will contribute in gate-stack engineering, oxidation processes, ultra-shallow junctions, silicate formation, low-k dielectric annealing and in fundamental improvement of thin film properties. As device dimensions are controlled at the atomic scale, the concepts of thermal budget reduction will continue to drive the technology, with reductions in both process times and process temperatures combined with control of a very high purity process gas ambient

In CMOS technology [6] Accompanying of MEMS sensor using in consumer production widely, system in package (Sip) technology becomes popular to integrate CMOS device (such as ASIC or DSP) with MEMS sensor together. It is excellent to connect sensor to signal amplifier directly to deduce RC delay and board level noise. However, with CMOS technology evolution to 0.13um or 90nm, the thermal stability temperature of low k IMD material (such as black diamond or a-F:C) is around 400°C. That means for this CMOS/MEMS Sip technology, the first challenge is to develop low temperature process, which has to be compatible with the thermal budget of the CMOS devices. In this paper, the temperature target is set as 350 °C for this concern. Secondly, the next challenge is the manufacturing method for this CMOS/MEMS Sip technology.

TVS based 3D integration [7] three dimensional (3D) semiconductor circuit integration has been an active area of research recently. Part of the driving force behind this interest has been applications. In this paper, we identify applications that drive 3D integration and point out the challenges they bring. In particular, we focus on through silicon via-based (TSV-based) 3D integration.

TSV-based 3D integration opens up a new genre, and new opportunities for semiconductor integrated circuits. After a brief overview of TSV-based 3D technology overview, we identify driver applications that are dominant in this transition. We then point out challenges in the manufacturing area, i.e., thermal, reliability, EDA, cost, and test.

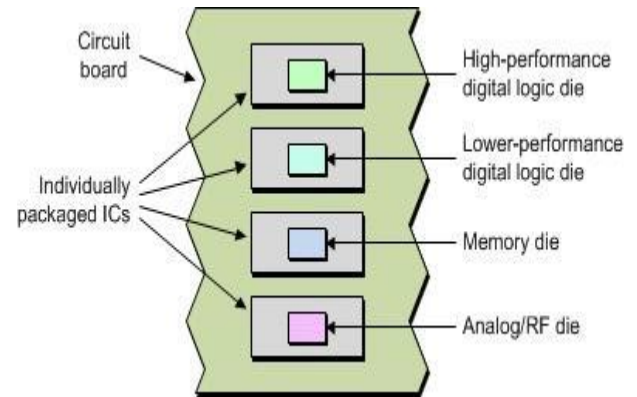

Figure 1: TSV 3-D IC Performance

In heat sink method [8] Traditional design methods to achieve improvement in heat sink performance are not suitable for meeting new thermal challenges. Revolutionary rather than evolutionary concepts are required for removing heat from the electronic components. We have recently developed an emerging novel approach, the integration design of the forced convection air cooling system. The aerodynamic design for the miniature axial-flow fan is conducted and a CPU fan is designed to be integrated with the radial fins in order to form a complete fan-heat sink assembly. The 3-D data of the fan generated by FORTRAN program are imported into Pro/E to create its 3-D model. The performance curve of the fan prototype fabricated by the computer numerically controlled machine is tested in a standard wind tunnel. To reduce the economic cost and prompt the design efficiency, the computational fluid dynamics is adopted to estimate the initial fan's performance. A series of radial heat sinks is designed in accordance with the outflow angle of airflow discharged from the fan.

Power dissipation is expected to increase exponentially to 150-250 W per chip over the next decade. [9] To manage this large heat output, it is necessary to minimize the thermal resistance between the chip and a heat dissipation unit that the device is attached to. It is therefore important to further improve the thermal performance of thermal interface materials (TIMs), which can be achieved through 1) improvement of the bulk thermal conductivity of TIMs; and/or 2) reduction of interfacial thermal resistances between the

National Conference on Current Trends in Engineering, Science and Technology (NACCTEST- 2018)
 Organized by GF's Godavari College of Engineering, Jalgaon
International Journal of Innovations in Engineering and Science, Special Conference Issue, 2018
www.ijies.net

TIM and the device and/or TIM and the heat dissipation unit. The latter improvement may be obtained by enhanced physical properties of TIMs (e.g., viscosity or wetting ability) and/or surface modification of the heat dissipation unit or the inactive side of the device. Researchers have tried to take advantage of the high 1D thermal conductivities of graphite fibers, and more recently of carbon nanotubes (CNT), to reduce the thermal resistance between the chip and the heat dissipation unit. The efforts can be classified into three categories: 1) Forming pre-aligned graphite fiber or CNT films that have high bulk thermal conductivities in the heat transport direction, and applying such films as TIMs; 2) incorporating randomly oriented graphite fibers or CNT into silicone or epoxy matrices in the presence or absence of a second filler to improve.

In this method [10] Transition metal (TM) doped II-VI chalcogenide laser materials offer a unique blend of physical, spectroscopic, and technological parameters that make them the gain media of choice for cost effective broadly tunable lasing in the Mid-IR. The II-VI semiconductor hosts provide a low phonon cut-off, broad IR transparency, and high thermal conductivity. When doped with transition metal ions, these materials feature ultra-broadband gain, low saturation intensities, and large pump absorption coefficients. This combined with the low-cost mass production technology of crystal fabrication by post growth thermal diffusion, as well as broad availability of convenient pump sources, make these materials ideal candidates for broadly tunable mid-IR lasing in CW, gain-switched, free running, and mode-locked regimes of operation. This review summarizes experimental results on optically pumped lasers based on Cr and Fe doped II-VI wide band semiconductors providing access to the 1.9-6 μm spectral range with a high (exceeding 60%) efficiency, multi-Watt-level (18 W in gain switch and 30 W in pure CW) output powers, tenability in excess of 1000 nm, short-pulse (<50 fs) multi-watt oscillation, multi-Joule long-pulse output energy, and narrow spectral line width (<100 kHz).

In this method wind power technology [11] As a key component in the wind turbine system, the power electronic converter and its power semiconductors suffer from complicated power loadings related to environment, and are proven to have high failure rates. Therefore, correct lifetime estimation of wind power

converter is crucial for the reliability improvement and also for cost reduction of wind power technology. Unfortunately, the existing lifetime estimation methods for the power electronic converter are not yet suitable in the wind power application, because the comprehensive mission profiles are not well specified and included. Consequently, a relative more advanced approach is proposed in this paper, which is based on the loading and strength analysis of devices and takes into account different time constants of the thermal behaviors in power converter. An automated physical [12] design and architecture performance estimation flow for 3D architectural evaluation which includes 3D floor planning, routing, interconnect pipelining and automated thermal via insertion, and associated die size, performance, and thermal modeling capabilities. We have proposed the accelerator-over-processor computing platform as shown below. Although 3-D integration shows promise, significant challenges. . The most important issue in 3-D IC is heat dissipation. The thermal problem has already had an impact on the reliability and performance of high-performance 2-D ICs. The problem is aggravated in 3-D ICs, principally for two reasons: the devices are more packed, which results in higher power density and insulating dielectric layers between the device layers have much lower thermal conductivities than silicon This paper summarizes [13] an exploration of design strategies for a microprocessor-based adaptive thermal control system for heat-dissipating computer CPU modules. The thermal control system contains a cold plate with an air-cooled base mode and a thermo-electric heat pump element that can boost cooling performance when needed. The microprocessor programming includes models of the heat transfer in the cold plate and the thermal performance of the thermo-electric heat pump and the fan coolers. The microprocessor is programmed to compare the thermal control system model predictions to the existing operating conditions. The results of this comparison are used to facilitate control of the cooling system and to provide fault detection during its operation. This paper reports the progress of an ongoing study that will explore different ways that the computational capability of the processor can be used to minimize power consumption while maintaining adequate processor temperature control over broadly varying operating conditions. The investigation also explores the merits of different strategies for incorporating fault detection features into the

National Conference on Current Trends in Engineering, Science and Technology (NACCTEST- 2018)
 Organized by GF's Godavari College of Engineering, Jalgaon
International Journal of Innovations in Engineering and Science, Special Conference Issue, 2018
 www.ijies.net

microprocessor programming to enhance the reliability and robustness of the system. In this new method amplifiers [14] The Innoslab amplifier comprises a diode-laser partially end-pumped thin slab crystal and a folded single-pass optical amplification path. While this configuration differs in many respects from other slab amplifiers, it shares characteristics with partially end-pumped rod amplifiers. It combines outstanding thermal management, efficiency, and beam quality in the 100 W to 1 kW power range. In this paper, we review amplifiers for a wide range of operation regimes and laser materials.

In addition to reductions in feature size, another important trend lies in the increasing number of interconnect layers with the number of metal layers identified in the International Technology Roadmap for Semiconductors (ITRS) microprocessor interconnect technology requirements progressively increasing from seven in 2001 to thirteen for 2014. This introduces a higher density of interfaces and boundaries within the die structure, each of which can act as a thermal impedance to heat flow and Similarly, at the device level the move from traditional planar vertical nanowire wrap-gated devices and below figure represents a shift toward more complex device geometries and interface configurations.[15]

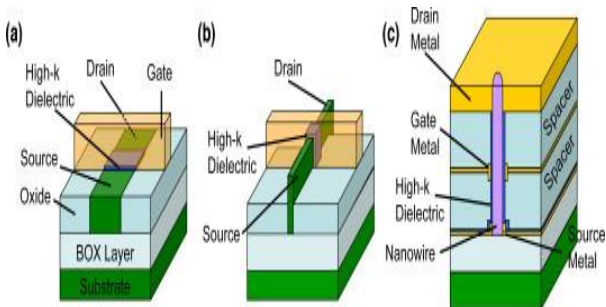

Figure 2: Complex device geometries and interface configurations.

Figure 2 shows the Complex device geometries and interface configurations. and figure , a) A traditional MOSFET design built on SOI wafer with 2D, top-gated planar channel. The associated buried oxide (BOX) layer is also noted. (b) Recently utilized 3D FinFET/multigate design. (c) Cross-section illustration of a vertical nanowire device with wrap-around gate. In this image,

the term 'high- k dielectric' refers to a material with high dielectric constant (k) rather than high thermal conductivity (κ).

In this method the heat flux density is described [16] the heat sink design of a Switching Mode Power Supply influences the EMC of the supply. The capacitive coupling between electronic power device and the heat sink are responsible for common-mode currents in the system. These currents create EMC problems. This paper proposes a new filter design to avoid heat sink radiation. In this method of heat sink [17] as a key component in the wind turbine system, the power electronic converter and its power semiconductors suffer from complicated power loadings related to environment, and are proven to have high failure rates. Therefore, correct lifetime estimation of wind power converter is crucial for the reliability improvement and also for cost reduction of wind power technology. Unfortunately, the existing lifetime estimation methods for power electronic converter is not yet suitable in the wind power application, because the comprehensive mission profiles are not well specified and included. Consequently, a relative more advanced approach is proposed in this paper, which is based on the

Loading and strength analysis of devices and takes into account different time constants of the thermal behaviors in power converter. With the established methods for loading and lifetime estimation for power devices, more detailed information of the lifetime-related performance of wind power converter can be obtained. Some experimental results are also included to validate the thermal behavior of power device under different mission profiles.

In thermal management of electronics devices are mentioned in these methods. As the computational capabilities of integrated systems grow, they become increasingly power-hungry. This dissipated power is converted to heat that must be removed from the system, and a failure to do so can result in excessive temperatures. The trends for thermal problems are severe enough along the Moore's law curve, but become even worse with the advent of 3D ICs, where the power density per unit footprint increases. Therefore, in future systems, it is a virtual certainty that thermal bottlenecks will gain center stage, and the problem of thermal management must be tackled aggressively at

National Conference on Current Trends in Engineering, Science and Technology (NACCTEST- 2018)
 Organized by GF's Godavari College of Engineering, Jalgaon
International Journal of Innovations in Engineering and Science, Special Conference Issue, 2018
www.ijies.net

all levels of design. At the chip level, the focus of thermally-aware design is chip thermal management. Thermal variations during the operation of a circuit can result in changes or unpredictability in its performance and reliability. It is essential to solve the problem of thermally-aware design at all levels, developing techniques that range from presilicon analysis and optimization to post silicon mitigation, taking into account all of the effects associated with elevated temperatures. This talk will provide an overview of challenges and opportunities in this domain. [18]

In the longstanding endeavor to access the [19] quantum nature of macroscopic mechanical motion, the experimental challenge is not only that of state preparation, but also one of measurement. The flourishing field of cavity opt mechanics, in which an electromagnetic resonance couples parametrically to a mechanical oscillator, addresses both of these challenges-providing a nearly ideal architecture for both manipulation and detection of mechanical motion at the quantum level. In which the motion of a high-Q, micromechanical membrane couples to a superconducting microwave resonator. When this 'cavity' is excited with coherent microwave photons near its resonance, the displacement of the membrane becomes encoded as modulation of this tone. The microwaves, in turn, also impart forces back on the oscillator, which enforce the Heisenberg limits on measurement and can also be exploited either to cool or amplify the motion. The unprecedented opt mechanical coupling strength allows the driven system to enter the strong-coupling regime, where the normal modes are now hybrids of the original radio-frequency mechanical and the microwave electrical resonances. This normal-mode splitting is verified by direct spectroscopy of the 'dressed states' of the hybridized cavity resonance, showing excellent agreement with theoretical predictions.

In the electric device the regulation method are specify [20] Recognition of technical specification for electric drives thermal sizing is quite challenging in both transportation applications and distributed generating systems. In particular, components of electric drives for hybrid farm equipment, like tractors as well large combines, are often overstressed because of either high

ambient temperature or overload working condition. The electric drive components are mainly chosen with reference to average power and energy considerations; however, overload operating conditions can occur for time durations not established in advance, as well quite unpredictable thermal conditions are associated to environment related to diesel engines in hybrid configurations.

Mobile systems require high-performance and low-power SoC or 3D-IC chips to perform complex operations, ensure a small form-factor and ensure a long battery life time. A low supply voltage (VDD) is frequently utilized to suppress dynamic power consumption, standby current, and thermal effects in SoC and 3D-IC. Furthermore, lowering the VDD reduces the voltage stress of the devices and slows the aging of chips. However, a low VDD for embedded memories can cause functional failure and low yield. This paper reviews various challenges in the design of low-voltage circuits for embedded memory (SRAM and ROM). It also discusses emerging embedded memory solutions. [21]

In the inductor design method [22] the design of high power inductors for applications with broad current spectrum excitation is a challenging task. The resonant inductor of a resonant DC link inverter (RDCLI) is one such example. The inductor current consists of a resonant current component, a DC component which supplies the active power to the load and a modulation component which depends on the modulation strategy. In addition, the frequency and amplitude of the dominant current components change with operating point. Conventional inductor designs for single frequency excitation do not perform well in broad spectrum applications. In order to improve these designs, the impact of broad current spectrums on winding design, core selection, power density and thermal handling capability must be investigated. In this paper, alternate inductor topologies which better address the above issues are proposed and investigated.

In the RF power amplifier [23] the trends in RF power amplifier (RFPA) modules for handsets are optimization of active device technology, circuit topology and packaging to enhance cost, size, performance, and ease of implementation. For the package in RFPA module manufacturing, device-to-board attach solder reflow

National Conference on Current Trends in Engineering, Science and Technology (NACCTEST- 2018)
Organized by GF's Godavari College of Engineering, Jalgaon
International Journal of Innovations in Engineering and Science, Special Conference Issue, 2018
www.ijies.net

condition and moisture sensitivity level (MSL) are the most challenging areas for further improvement in thermal management due to "lead-free" application which causes catastrophic failure by high temperature application. In consequence, we have been faced with industrial requirements to improve both MSL and reflow temperature without any catastrophic phenomena such as solder extrusion and solder flow in RFPA modules. This paper discusses various considerations to define critical factors that will affect thermal and moisture induced stress in RFPA modules in long term reliability assurance at the package design stage.

In this method the high temperature of electronics [24] the under hood automotive environment is harsh and current trends in the automotive electronics industry will be pushing the temperature envelope for electronic components. The desire to place engine control units on the engine and transmission control units either on or in the transmission will push the ambient temperature above 125°C. However, extreme cost pressures, increasing reliability demands (10 year/241 350 km) and the cost of field failures (recalls, liability, and customer loyalty) will make the shift to higher temperatures occur incrementally. The coolest spots on engine and in the transmission will be used. These large bodies do provide considerable heat sinking to reduce temperature rise due to power dissipation in the control unit. The majority of near term applications will be at 150°C or less and these will be worst case temperatures, not nominal. The transition to X-by-wire technology, replacing mechanical and hydraulic systems with electromechanical systems will require more power electronics.

In this technique packaging substrate of next decade [25] Organic packaging substrates are still dominant in the worldwide market not only for high performance and cost performance applications but also stacked memory applications. Since increasing signal transmitting speed and decreasing operating voltage, packaging substrate requires higher density of circuits with thinner materials to assure signal integrity. It is quite difficult challenges not only for packaging substrate manufacturers but also materials suppliers to assure required electrical performance such as signal integrity and power integrity together with mechanical strength and thermal management. In addition, current organic

packaging substrate technology approaching to fabrication technology limit in terms of manufacturing process, base materials, test and engineering staff. In addition to achieve sub-10 microns wiring production, capital investment requires more than 500 million US\$.

In the power electronics the heat exchange [26] Electric-drive systems, which include electric machines and power electronics, are a key enabling technology to meet increasing automotive fuel economy standards, improve energy security, address environmental concerns, and support economic development. Enabling cost-effective electric-drive systems requires reductions in inverter power semiconductor area, which increases challenges associated with heat removal. In this paper, we demonstrate an integrated approach to the design of thermal management systems for power semiconductors that matches the passive thermal resistance of the packaging with the active convective cooling performance of the heat exchanger. The heat exchanger concept builds on existing semiconductor thermal management improvements described in literature and patents, which include improved bonded interface materials, direct cooling of the semiconductor packages, and double-sided cooling. The key difference in the described concept is the achievement of high heat transfer performance with less aggressive cooling techniques by optimizing the passive and active heat transfer paths .

In this paper the design and the implementation of low power digital devices has become of extreme importance; therefore, the problem of reducing the power dissipated by CMOS circuits has been addressed on several fronts. Current research has focused on architectural and technological transformations, re-implementation of logic synthesis procedures, and modification of technology mapping algorithms to produce low power circuits; although the results obtained so far are very encouraging, there is one aspect of the overall synthesis process which has not been faced with enough care: the design of cell libraries to be used for the realization of the synthesized design. data concerning the impact that cell library characteristics may have on the power consumption of CMOS devices. [27]

National Conference on Current Trends in Engineering, Science and Technology (NACCTEST- 2018)
 Organized by GF's Godavari College of Engineering, Jalgaon
International Journal of Innovations in Engineering and Science, Special Conference Issue, 2018
 www.ijies.net

In this technique noise circuit for accurately testing mixed signal ICs [28] a substrate coupling noise measurement technique is presented in this paper. The proposed on-chip test circuit can accurately and efficiently measure substrate coupling noise in any type of semiconductor substrate. The measured substrate coupling voltage is converted to a digital code by a simple on-chip analog-to-digital converter. The I/O pads, bounding wires, package frame, external cables, and test fixture/circuit do not affect the accuracy of the measurement. On-chip calibration is also included to further extend the test accuracy. The circuit provides an effective substrate coupling noise test technique for evaluating a variety of existing substrate coupling noise models. Less than 0.4% error as compared to SPICE is achieved.

In the digital storage network of Electromagnetic delay systems are very attractive for digit pattern storage in electronic computing equipment. No transducers are required, so that the efficiency can be made high, and only familiar components are used. It is well known, however, that neither the continuously-wound nor the lumped-constant type of conventional delay line can be made to give sufficient resolution to store more than perhaps 15 digits without great difficulty. A method of design for lattice-type delay networks is described, depending on the Fourier transform of the required pulse response, which enables a network to be designed with an output of the optimum form. A valve is used for inversion so that a minimum number of components is required and both input and output are single-ended, thus overcoming the usual disadvantages of the lattice arrangement. [29]

In this technique the [30] Plasma based deposition is being adapted in order to be useful in a wider range of applications and to create more sophisticated coatings and surface hardenings. Important in this evolution is the ability to understand the plasma environment so that researchers can develop an understanding of how the plasma parameters, characteristics, and composition determine the materials properties, performance, and structure of the material. This can best be accomplished with a well-characterized source in which the plasma behavior and composition can be related to materials properties. Recent work in materials development has focused on multilateral coatings and nana-composites.

Particular areas of interest for these types of materials include solid lubricants, claddings for nuclear sensors and fuel, functioning coating.

In the thermal management issue in laser diode packaging [31] SAMEER has recently setup an infrastructure to dasiapigtail and package laser diodespsila using optical epoxy and laser weld techniques. Few laser diodes have been packaged using dasiafiber alignment and laser weld system (FALWS) pile in butterfly and TO-CAN packages. The high power laser diode packaging involves good thermal management and post-weld shift challenges, and it is being experimentally verified with theoretical simulation. The laser diode packaging followed by reliability test as per Telcordia standard is the current technical challenges ahead.

In the power increment and VSWR characteristics improvement of termination resistor [32] Matching RF and Microwave signals to components within a circuit has become more challenging for circuit designer as operating frequency and power handling requirement increase. Termination resistors with excellent power handling capability with superior voltage standing wave ratio (VSWR) characteristics are needed for microwave circuit components in various wireless and telecommunication application. In this work, we extensively studied to improve the power handling capability and VSWR of termination resistor while maintaining the smaller size. We optimized the energy transmission within the component and significantly improved the efficiency of energy transfer between the transmission lines and the terminations. We discussed techniques of improving power handling capability and reduction of thermal fatigue to the component's structure. By using innovative techniques of heat transfer we appreciably increased power handling capability while keeping the product size as minimum. We improved the package technology and reduced the chance of solder cracking due to thermal fatigue. . We optimized impedance matching by varying length, width and pattern of transmission line as well as using defective ground structure (DGS) technique. We minimized the detrimental influence of component footprint and resistor material characteristics effect on signal reflection.

National Conference on Current Trends in Engineering, Science and Technology (NACCTEST- 2018)
Organized by GF's Godavari College of Engineering, Jalgaon
International Journal of Innovations in Engineering and Science, Special Conference Issue, 2018
www.ijies.net

CONCLUSION

In an ever increasing electronic application market, the fundamental contribution of CMOS technology, RF circuits, power semiconductor devices, microprocessor and microcontroller techniques. Higher power semiconductor diode technology is rapidly maturing technically and commercially along with diode bar improvement, enhancement in the component and system design must be developed in order to handle the increased current and heat loads at the high power. The 3D problems can be divided into 2D sub problem by design low an alternative stacking architecture to improve existing partitioning technique to reduced the area other alternative stacking IC and number of 3D-via in the design style. These system are continuous drive to improving devices and functionally and operational parameter. Future development will maintain similar past trends for growing system demands in Termed to increased power level and greater control reliability.

REFERENCES

- [1] J. Davis, et al., "Interconnect limits on gigascale integration (GSI) in the 21st century," *Proceedings of the IEEE, Microsystems, Packaging, Assembly & Circuits Technology Conference, 2008. IMPACT 2008. 3rd International.*
- [2] Synopsys, Proc. . . .Challenges of power electronic packaging and modeling. *Thermal, Mechanical and Multi-Physics Simulation and Experiments in Microelectronics and Microsystems (EuroSimE), 2011 12th International Conference on 2011*
- [3] Davis, PhD dissertation, Georgia Institute of Technology, Metal contacts to wide bandgap semiconductor structures *International Conference on for RF power applications. Microwave Radar and Wireless Communications (MIKON), 2010 18th Int IEEE*
- [4] Christie, P.; Stroobandt, D.; , "The interpretation and application of Rent's rule," *Very Large Scale Integration (VLSI) Systems, IEEE Transactions on Computer-Aided Design of Integrated Circuits and Systems, IEEE Transactions on (Volume:30, Issue: 9)*
- [5] RTP application and technology options for the sub-45 nm nodes...*Advanced Thermal Processing of Semiconductors, 2004. RTP 2004. 12th IEEE International Conference on 2004*
- [6] D. C. Sekar, PhD dissertation, Georgia Institute of Technology, Metal-to-metal bonding technology for MEMS application *Microsystems Packaging Assembly and Circuits Technology Conference (IMPACT), 2010 5th International 2010*
- [7] N. Magen, et al., Proc. System Level Interconnect Prediction. *3D Chips can be cool: Thermal study of VeSFET-based ICs Electronic Components and Technology Conference (ECTC), 2013 IEEE 63rd*
- [8] . Naffziger, B. Stackhouse, T. Grutkowski *Design and Simulation of the CPU Fan and Heat Sinks Components and Packaging Technologies, IEEE Transactions on (Volume:31, Issue: 4)2011*
- [9] [9] S. Faulstich, P. Lyding, B. Hahn, and P. Tavner, "Reliability of offshore turbines—identifying the risk by onshore experience," in *Proc. Eur Offshore Wind, Stockholm, Sweden, 2009, pp. 1*
- [10] *Development of the thin film with high thermal conductivity for power devices. Electronic devices*
- [11] S. Naffziger, B. Stackhouse, T. Grutkowski, "The implementation of a 2 core multi-threaded Itanium family processor", *Proc. Intl. Solid State Circuits Conference*
- [12] R. Ramachandran *Utilization of carbon fibers in thermal management of microelectronics Advanced Packaging Materials: Processes, Properties and Interfaces, Proceedings. International Symposium on 2005*
- [13] *Progress in Mid-IR Lasers Based on Cr and Fe-Doped II–VI Chalcogenides Selected Topics in Quantum Electronics, IEEE Journal of (Volume:21, Issue: 1)*
- [14] Thermal Loading and Lifetime Estimation for Power Device Considering Mission Profiles in Wind Power Converter *Power Electronics, IEEE Transactions on (Volume:30, Issue: 2) 2010*
- [15] *Innoslab Amplifiers Selected Topics in Quantum Electronics, IEEE Journal of (Volume:21, Issue: 1)2011*
- [16] Heat Flux or Thermal Flux is the rate of heat energy transfer through a surface. Heat flux density is the heat flux unit per area http://en.wikipedia.org/wiki/Heat_flux
- [17] Damiano, A., Gatto, G., Marongiu, I., and Piroddi, A.: A heat sink model for EMI resonance frequency determination, *Power Electronics Specialists Conference, vol. 1, pp. 273–277, 2004.*
- [18] *Low Power Electronics and Design (ISLPED) 2011 International Symposium on The whys and hows of thermal management*

National Conference on Current Trends in Engineering, Science and Technology (NACCTEST- 2018)
 Organized by GF's Godavari College of Engineering, Jalgaon
International Journal of Innovations in Engineering and Science, Special Conference Issue, 2018
www.ijies.net

- [19] H. Wang, M. Liserre, F. Blaabjerg, P. de Place Rimmen, J. B. Jacobsen, *Microwave opt mechanics in the strong coupling regime. [Lasers and Electro-Optics Europe \(CLEO EUROPE/EQEC\), 2011 Conference on and 12th European Quantum Electronics Conference](#)*
- [20] E. Wolfgang, "Examples for failures in power electronics systems," presented
- [21] at ECPE Tuts. Rel. Power Electron. Syst., Nuremberg, German 2007
- [22] M.-F. Chang and S.-J. Shen, "A process variation tolerant embedded split-gate Flash memory using pre-stable current sensing scheme," *IEEE J. Solid-State Circuits*, vol. 44, no. 3, pp.987-994, March 2009.
- [23] *Inductor design for high power applications with broad spectrum excitation [Power Electronics Specialists Conference, 1995. PESC '95 Record., 26th Annual IEEE](#) (Volume:2) 1995*
- [24] *Thermal and moisture induced stressing effects of RF power amplifier modules [Electronic Materials and Packaging, 2001. EMAP 2001. Advances in 2001](#)*
- [25] G. Leen and D. Heffernan, "Expanding automotive electronic systems", *IEEE Computer*, no. 1, pp.88 -93 2002
- [26] *Interconnection Technol., Inc., Suwa [Microsystems, Packaging, Assembly & Circuits Technology Conference, 2008. IMPACT 2008. 3rd International.](#)*
- [27] S. Davis, S. Diegel, and R. Boundy, *Transportation Energy Data Book, 32nd ed. Oak Ridge National Laboratory, 2013.*
- [28] A. P. Chandrakasan , S. Sheng and R. W. Brodersen "Low-Power CMOS Digital Design", *IEEE Journal of Solid-State Circuits*, vol. 37, no. 4, pp.473 -484 1992.
- [29] *Dept. of Electra. & Compute. Eng., Rochester Univ., NY, USA [Circuits and Systems, 2002. ISCAS 2002. IEEE International Symposium on](#) (Volume:1)*
- [30] *Electromagnetic delay networks for digital storage [Proceedings of the IEE - Part B: Radio and Electronic Engineering](#) (Volume:103 , Issue: 3) 2009*
- [31] *Nucl. Eng. Program Blacksburg, Virginia Polytech. Inst. & State Univ., Blacksburg, VA, USA [Plasma Science \(ICOPS\), 2013 IEEE International Conference](#)*
- [32] E. Desurvire, D. Bayart, B. Desthieux, and S. Bigo, *Erbium-Doped Fiber Amplifiers, Device and System Developments. [Semiconductor Electronics, 2008. ICSE 2008. IEEE International Conference on](#) 2008*
- [33] H. Wang, H. Shao, Z. Li, B. Liang, and F. Lin, "Development of simulant high power resistor," *Precision Electromagnetic Measurement Digest, CPEM 2008*, pp. 404, June. 2008.

Smart Weighing Scales in Shopping Malls: A Critical Review

Sunil Khangal¹, I.S.Jadhav², V. D. Chaudhari³, Shafique Ansari⁴, H. V. Dhande⁵, D. P. Marathe⁶

¹ PG Scholar (VLSI & ESD), ^{2,3,4,5,6} Assistant Professor

^{1,2,3,4,5,6} Dept. Of E&TC Engg, GF's Godavari College of Engineering, Jalgaon, Maharashtra, India. Pin-425001

²ishwar.jadhav@rediffmail.com

Abstract - The electronic weighing scale available is in price computing scale mode along with camera and printer. The fruit and vegetable departments of large supermarkets offer an overwhelming choice of fresh products. Consumers benefit from this broad selection, as most fruits are now available year round. Another advantage of self-service supermarkets is that consumers can check and choose the fruit and vegetables themselves. A compact, integrated camera helps self-service scales automatically recognize individual products. The analysis process starts automatically as soon as a presented for selection in large, coloured fields. The computer vision strategies used to recognize a fruit rely on four basic features which characterize the object: intensity, colour, shape and texture. This seminar proposes an efficient fusion of colour and texture features for fruit recognition. The consumer can now choose the desired type, and the scale prints the label. Due to various disturbance factors, a fully automatic system cannot be implemented, as highly fluctuating light conditions or covered areas in the image affect the analysis. If conditions are good, however, the camera system achieves a high accuracy even if the weighed products are in plastic bags. weight is placed on the scale. The scale's operating panel displays: "Recognition in progress." First, the scale checks whether the image captured by the camera changes; for example, because the user's hand was in the field of view. As soon as the image

remains still, the system starts analyzing. This takes about a second. Then four possible matches are

Keywords – electronics weighing scales, self-service super markets, colour fusion, texture.

INTRIDUCTION

The electronic weighing scale available is in price computing scale mode along with camera, printer. The analysis process starts automatically as soon as a weight is placed on the scale. The scale's operating panel displays: "Recognition in progress." First, the scale checks whether the image captured by the camera. The computer vision strategies used to recognize a fruit rely on four basic features which characterize the object: intensity, colour, shape and texture. This paper proposes an efficient fusion of colour and texture features for fruit recognition. A number of challenges had to be overcome to enable the system to perform automatic recognition of the kind of fruit or vegetable using the images from the camera, many kind of fruits are subject to significant variation in colour and texture.

The major advantage of electronic weighing scale is accuracy, precision and reliability. electronic scale finds more popularity in vegetable shops, health industries and especially to identify the measurement of the tiny things. The prominent features of the system are low cost, easy maintenance, flexible

design and multipurpose. The ZigBee is considered for wireless communication. The major advantage of this system is the change in commodity price can be updated automatically from host PC. More than one wireless electronic scale can be connected to the Host PC by the implementation of ZigBee cluster tree network. The fruit and vegetable departments of large supermarkets offer an overwhelming choice of fresh products. Consumers benefit from this broad selection, as most fruits are now available year round. Another advantage of self-service supermarkets is that consumers can check and choose the fruit and vegetables themselves. It requires manual operation to store time, date and weight of goods. Also, the change in commodity price can be updated only through manual operators. It makes the process so complicated to use and difficult to get sales report and goods consumption habit of consumers. It is also hard to have better inventory management on goods. To overcome the difficulties the large supermarket uses expensive electronic scale but it did not have the capacity to store the information and it is not affordable for ordinary users.

LITERATURE SURVEY

The methodology (1) presented is able to recognize spherical fruits in natural conditions facing difficult situations: shadows, bright areas, occlusions and overlapping fruits. The sensor used is a laser range-finder giving range/attenuation data of the sensed surface. The recognition system uses a laser range-finder model and a dual color/shape analysis algorithm to locate the fruit. The use of image processing for grading is being applied to many products, including oranges, potatoes, apples, carrots, green peppers, tomatoes and peaches. The grading may be for size and shape, color, or the presence of defects. The use of robots to pick tree fruits was first proposed by Schertz and Brown in a review of mechanical citrus harvesting systems. The basic concepts of robotic harvesting were established. One of these concepts was the line-of-sight approach to fruit picking. This consists of the following three

steps: 1) to visually locate the fruit with an optical sensor, 2) to guide the fruit detachment device along the line of sight to the fruit, and 3) to actuate the device when the fruit is contacted. A robotic system based on the Schertz approach consisting of a simple robotic arm, a B/W TV camera and a control computer was built for the harvesting of apples. The computer vision strategies used to recognize a fruit rely on four basic features which characterize the object: intensity, color shape and texture.

A simple (2) color recognition algorithm using a Neural Network model and applied to determine the ripeness of a banana. The captured image of the banana is resized and its RGB color components are extracted. The color components of the resized images are rescaled using a simple heuristic method. Further, a histogram for the rescaled image is obtained and used as a feature vector to identify the ripeness of the banana. A simple graphical user interface system is developed in MATLAB that classifies the ripeness of the banana. The normal human eyes have three types of sensors and the signal of these three sensors determine the color response of the observer. The response of this system produces the three-dimensional phenomenon of three dimensional spaces. The color recognition model has been applied widely in industrial sectors, commercial fields as well as in social responsibilities. For instance, it is used as a powerful and reliable parameter in robotics machines, aid for the blind and the color blind people, diamond color sorting, quality control for the manufacture colored

The Method is used Fresh fruits harvesting (3) is a sensitive operation. Its profitability may be influenced by labour inaptitude, costs and unavailability, low quality harvesting, and operation untimeliness. Edge detection and combination of color and shape analyses was utilized to segment images of red apples obtained under natural lighting. Thirty images were acquired from an orchard in order to find an apple in each image and to determine its location. Two algorithms (edge detection-based and

colour shape based) were developed to process the images. They were filtered, converted to



Figure 1.1 Resized image of banana

Figure 1.2 Red component image of the banana

strategies for the recognition of fruits, but some problems binary images, and noise reduced. The first operation needs development of appropriate methods to detect and locate the fruits. Using photometric information based and infrared laser range finding methods were developed. While, image processing based methods have been used to detect and located the fruits. Both intensity/colour pixel-based and shape-based analysis methods were appropriate arose from the variability of the sensed image itself when using CCD cameras, which are very sensitive to changes in sunlight intensity as well as shadows produced by the leaves.

The aim of technic (4) is to develop machine vision techniques based on image processing techniques for estimation the quality of orange and tomato fruits and to evaluate the efficiency of these techniques regarding the following quality attributes: size, colour, texture and detection of the external blemishes. The use of machine vision for the inspection of fruits and vegetables has increased during Machine vision is the study of the principles underlying human visual perception, and it attempts to provide the computer-camera system the visual capabilities easily accomplished by humans. In the human eye-brain system the human eye receives light from an object and then converts the light into electric signals. recent years. Nowadays, several manufacturers around the world produce sorting machines capable of pre-grading fruits by size, colour and weight. Machine vision and image



Figure 2: Edge detection based algorithm. a) Original image, b) Edge-detected image
 Processing techniques have been found increasingly useful in the fruit industry, especially for applications in quality inspection and defect sorting applications.

Research in this area indicates the feasibility of using machine vision systems to improve product quality while freeing people from the traditional hand-sorting of agricultural materials.

A technology use to development (5) of image analysis and computer vision system in quality evaluation of products in the field of agriculture, Computer vision is a rapid, consistent and objective inspection technique, which has expanded into many diverse industries. Its speed and accuracy satisfy ever-increasing production and quality requirements, hence aiding in the development of totally automated processes. Some fruits have one colour homogeneously distributed on the skin surface, which is called primary colour. The averaged surface colour is a good quality indicator for these fruits. However, other fruits (e.g. some varieties of peaches, apples, tomatoes) have a secondary colour that can be used as a good indicator of maturity. In this case, it is not possible to rely only on the global colour as a quality parameter. Image processing offers solution for sorting of fruits based on their shape. Colour is also an important quality factor that has been widely studied. The colour of an object is determined by wavelength of light reflected from its surface. In biological materials the light varies widely as a function of wavelength. These spectral variations provide a unique key to machine vision and image analysis.

To develop a methodology (6) for assessing fruit quality objectively using texture analysis based on Curvelet Transform. Being a multi-resolution approach, curvelets have the capability to examine fruit surface at low and high resolution to extract both global and local details about fruit surface. The fruit images were acquired using a CCD color camera and guava and lemon were analyzed by experimentation. Textural measures based on curve let transform such as energy, entropy, mean and standard deviation were used to characterize fruits' surface texture. The food industry has widely used machine vision for quality

inspection of fruits, vegetable and processed food. The final application of such systems includes grading, estimation of the quality parameter from external or internal parameters. The overall appearance of fruit object is a combination of its chromatic attributes (color) and its geometric attributes (shape, size, texture), together with the presence of defects that can diminish the external quality.

The computer vision strategies used (7) to recognize a fruit rely on four basic features which characterize the object: intensity, color, shape and texture. This paper proposes an efficient fusion of color and texture features for fruit recognition. A number of challenges had to be overcome to enable

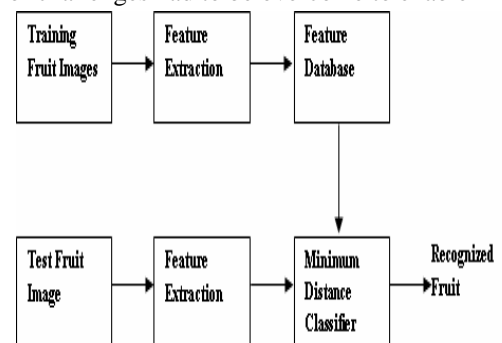

Figure 3: Fruit Recognition System

the system to perform automatic recognition of the kind of fruit or vegetable using the images from the camera, many kind of fruits are subject to significant variation in color and texture, depending on how ripe they are. For example, Bananas range from being uniformly green, to yellow, to patchy and brown.

Color features have been (8) extensively applied for apple quality evaluation mostly for defect detection. For instance, color features of each pixel in images obtained in three components of RGB spaces could be successfully used to segment defects on 'Jonagold' apples. Tomato is another food product in which color features are widely used, as color is an

indicator of the maturity of tomatoes. The early application of color features in tomato quality evaluation was preliminarily carried out by Sacker and Wolfe who used grey intensities of images to classify green and red tomatoes. Texture features are found to contain useful information for quality evaluation of fruit and vegetables.

The main idea of the project (9) is to create a complete self-functioning rapid billing and dispatch system in a super-market. The system basically consists of a cart fitted with an RF-detector linked to a billing server. When goods in departmental stores are added to the cart, the RF detector automatically detects the item type, quantity and sends the information to the billing server. The billing server simultaneously starts billing for the particular cart. In case the customer removes an item from the cart, the server immediately recognizes it and aligns the billing accordingly. The advantages of using such a system is that the time taken for billing huge amount of items is reduced greatly and it is very useful and secured in big shopping complexes.

The method is used an identification (10) and classification of different types of bulk fruit images using artificial neural networks. Schemes for visual classification usually proceed in two stages. First, features are extracted which represents the image and Second, a classifier is applied to the extracted features to reach a decision regarding the represented type of images. They have considered five different types of fruit images namely, Apple, Chickoo, Mango, Orange and Sweet lemon. The algorithms are developed to extract 18 color and 27 texture features. A Back Propagation Neural Network (BPNN) is used to classify and recognize the fruit image samples, using three different types of feature sets, color, texture, combination of both color and texture features. The study reveals that the combination of colour and texture features are out performed the individual colour and texture features in identification and classification of different bulk

fruit image samples. This paper presents an identification and classification of different types of bulk fruit images using artificial neural networks. Schemes for visual classification usually proceed in two stages. First, features are extracted which represents the image and Second, a classifier is applied to the extracted features to reach a decision regarding the represented type of images. We have considered five different types of fruit images namely, Apple, Chickoo, Mango, Orange and Sweet lemon. The algorithms are developed to extract 18 color and 27 texture features. A Back Propagation Neural Network (BPNN) is used to classify and recognize the fruit image samples, using three different types of feature sets, color, texture, combination of both color and texture features. The study reveals that the combination of color and texture features are out performed the individual color and texture features in identification and classification of different bulk fruit image samples

An Automatic Ration Materials Distribution (11) Based on GSM (Global System for Mobile) and RFID (Radio Frequency Identification) technology instead of ration cards. To get the materials in ration shops need to show the RFID tag into the RFID reader, then controller check the customer codes and details of amounts in the card. After verification, these systems show the amount details. Then customer need to enter they required materials by using keyboard, after receiving materials controller send the information to government office and customer through GSM technology. In this system provides the materials automatically without help of humans. In the RFID based Bill Generation and Payment through Mobile system is implemented. In this paper, the bill generating in super market using RFID technology and payment through mobile phone. Mobile payments will become one of the most important mobile services.

In a new model of automated grading system (12) for oil palm fruit is developed using the

RGB color model and artificial fuzzy logic. The mean color intensity based on RGB color model is determined and achieved 86.67% accuracy in overall categories. The samples of different fruits like Apple, Chikku, Banana, Orange and Pineapple are considered. Each sample of fruits are sliced into pieces and placed on the tray. The RGB color features extracted from the images from the knowledge base. Reorganization of different kinds of fruits, vegetables, seeds is a challenging and recurrent task in supermarkets. The cashier must be able to identify the species of particular type and its variety. Developing a system for classification of vegetables is a difficult task because of similarities among different classes. In a real environment, images of vegetables are often taken in super markets where the lighting condition varies with time and also noise due obstacles, shadow of vegetables as well as other objects around the vegetables like human passing nearby vegetables etc. Also, there is lot more variation in viewpoint, occlusions, scale of vegetable images. All these problems lead to a confusion across classes and make the task of vegetable classification more challenging.

Fruit sorting and grading is done up (13) to some extent on basis of knowledge, experience or some other technique but the efficiency can be improved by upgrading the sorting and grading process. In this study the intelligent system is designed using image processing techniques and fuzzy logics. Quality itself is defined as the sum of all those attributes which can lead to the production of products acceptable to the consumer when they are combined. The basis of quality assessment is often subjective with attributes such as appearance, smell, texture, and flavor, frequently examined by human inspectors. Color and shape are the fundamental character of natural images, and plays an important role in visual perception. The process of color classification involves extraction of useful information concerning the spectral properties of object surfaces and discovering the best match from a

set of known descriptions or class models to implement the recognition task shape is one of the most active topics in machine intelligence and pattern analysis since the 1950s which tries to discriminate different patterns of images

The proposed method can process, analyze, (14) classify and identify the fruits images, which are selected and sent in to the system based on color, shape and size and surf features of the fruit. The FCM algorithm is the appropriate and effective classification algorithm to be used in the Fruits Recognition System. The recognition system that has been developed is able to recognize all the test fruit images which are being selected by a user from the fruit selection menu which is based on GUI block in MATLAB on the system. The fruits recognition system could be applied as an image contents descriptor which is able to describe the low level visual features or contents of the fruit images for the CBIR system. The most popular analysis techniques that have been used for both recognition and classifications of two dimensional (2D) fruit images are color-based and shape-based analysis methods. However, different fruit images may have similar or identical color and shape values. Hence, using color, size and shape features analysis methods are still not robust and effective enough to identify and distinguish fruits images. Some existing systems which are based on fruit recognition and are referred for the proposed topic that analyze fruits using shape-based and color-based analysis method have been reviewed. The existing systems are: New Method for Fruits Recognition System, Recognition of Fruits in Fruits Salad, and Mango Grading by Using Fuzzy Image Analysis. fruit recognition has analyze, classify and identify the fruits images, which are selected and sent in to the system based on color, shape and size features of the fruit. The KNN algorithm is the appropriate and effective classification algorithm to be used in the Fruits Recognition System.

The food grain types and their quality are (15) rapidly assessed through visual inspection by human inspectors. The decision making capabilities of human inspection are subjected to external influences such as fatigue, vengeance, bias etc. with the help of image processing we can overcome that. By image processing we can also identify any broken grains mixed. The quality of the world's most important staple food crop can be determined based on the shape size and texture of the grain. In India the ever increasing population losses in handling and processing and the increased expectation of food products of high quality and safety standards there is need for the growth of accurate fast and objective quality determination of food grains. Now days we are using the chemical methods for the identification of rice grain seed varieties and quality.

A new vision system to characterize (16) the recognition of vegetables in images has been developed. It is always related to image processing, which can control the classification, qualification and segmentation of images. It is a recognition system for super market and grocery stores. From the captured images multiple recognition clues such as color, shape, size, texture and weight are extracted and analyzed to classify and recognize the vegetables. Present automatic recognition system (vegetable vision) to facilitate the checkout process of a supermarket or grocery stores. Vegetable vision is done with the image processing and image analyzing. Image processing is done by MATLAB. This system consists of an integrated measurement and imaging technology with a user friendly interface. When we bring a vegetable at checkout point, an image is taken, a variety of features such as color, shape, size, density, texture are then extracted. These features are compared to stored data. Depending on the certainty of the classification and recognition, the final decision is made by the system. Vegetable quality is frequently referred to size, shape, mass, firmness, color and bruises from which fruits can be classified and sorted. The classification technique is used to

recognize the vegetable's shape, size, color and texture at a unique glance.

The fruits recognition used color (17) images of fruits for defect segmentation. Defect segmentation is carried out into two stages. At first, the pixels are clustered based on their color and spatial features, where the clustering process is accomplished. Then the clustered blocks are merged to a specific number of regions. Using this two step procedure, it is possible to increase the computational efficiency avoiding feature extraction for every pixel in the image of fruits. Although the color is not commonly used for defect segmentation, it produces a high discriminative power for different regions of image. This approach thus provides a feasible robust solution for defect segmentation of fruits. Modern agricultural science and technology is extreme advance. The value of fruit depends on the quality of fruit. It is an important issue how to assay quality of fruit in agricultural science and technology. The classical approach of fruits quality assessment is done by the experts and it is very time consuming.

A fruit-by-fruit harvesting robot has not only (18) to locate and characterize the fruits on a tree, but also to detect the obstacles for a collision free operation. The detection techniques using spectral-based sensors rely on the differences in the reflectance spectra between fruits and the background, while the detection techniques using range-based sensors depend on the specificity of the fruit shape. Although many researchers have investigated this topic, recognizing and locating fruits on a tree are still a key challenge in developing such a robotic harvesting system due to the occlusion of the target fruits (by foliage, branches or other fruits) and the non-uniform and unstructured environment. Therefore, this study aimed at the development and validation of a system for the localization of apples and obstacles in the orchard based-on the color and depth images acquired with an RGB-D cam-era (Red, Green, Blue plus Depth). As an RGB-D camera provides both visual and 3D shape

information, it is very suitable for 3D perception, which is particularly relevant for robots operating in unstructured environments, Using both color and depth information, an algorithm to detect apples on tree was developed.

CONCLUSION

The proposed method can process, analyze and recognize fruits based on color and texture features. In order to improve the functionality and flexibility of the recognition system shape and size features can be combined together with color and texture features. The Wireless electronic scale provides an efficient way of weighing goods, update detailed transaction information and exchange of data's and also saves all the information in a host PC. It is less expensive and affordable for an ordinary user. Further, by increasing the number of images in the database the recognition rate can be increased. This algorithm can be used for smart self-service scales. this scale provides a sophisticated shopping at vegetable, commercial, retail shops and make convenience in saving the transaction information at low cost. The analysis process starts automatically as soon as a weight is placed on the scale. The computer vision strategies used to recognize a fruit rely on four basic features which characterize the object: intensity, colour, shape and texture. This paper proposes an efficient fusion of colour and texture features for fruit recognition. Colour-shape based algorithm detected the image objects in the images better; however, it was more complicated than the edge detection. The scale's operating panel displays: "Recognition in progress." First, the scale checks whether the image captured by the camera changes. The machine vision system has been developed for the shoppers' convenience and makes the self-service scales exceedingly easy to use.

REFERENCES

- [1] A.R. Jiménez, A.K. Jain, R. Ceres1 and J.L. Pons "Automatic fruit recognition: A survey and new results using Range/Attenuation images"1999
- [2] Emad Aboeela*, William Edberg, "Color Recognition Algorithm using a Neural Network Model in Determining the Ripeness of a Banana" , *University of Massachusetts Dartmouth, North Dartmouth* ,Oct-2009
- [3] Ben Ammar Hatem, Hamam Habib "Apple Fruits Recognition Under Natural Luminance Using Machine Vision" *Advance Journal of Food Science and Technology*,2010
- [4] Daniel T. Fokum, Victor S. Frost, Fellow, "Understanding Color Image Processing by Machine Vision for Biological Materials" *IEEE Communication Survey & Tutorials*, VOL. 12, NO. 2, SECOND QUARTER 2010
- [5] P.Vijayakumar, V.Vijayalakshmi , " Application of Computer Vision Technique on Sorting and Grading of Fruits and Vegetables" *Proceedings of Conference on Mobile and Pervasive Computing*, 2010
- [6] I Trung Pham Quoc1, Min Chul Kimc, "Automated Skin Defect Identification System for Fruit Grading Based on Discrete Curvelet Transform" *International Journal of u- and e- Service, Science and Technology* Vol. 3, No. 3, Sept- 2010
- [7] Khadijah Kamarul Azizi, Dr. Wided Ismail, " Fruit Recognition using Color and Texture Features", *Journal of Theoretical and Applied Information Technology* Oct -2010
- [8] Anthony Busson, Alain Lambert, Dominique Gruyer, and Denis Gingras "High Speed Billing System in Departmental Stores", *Middle-East Journal of Scientific Research* NOVEMBER 2012
- [9]Asif Ali Laghari, M. Sulleman Memon and Agha Sheraz Pathan; "Identification and Classification of Bulk Fruits Images using Artificial Neural Networks", *International Journal of Engineering and Innovative Technology (IJEIT) Volume 1, Issue 3*, March 2012
- [10] S.P. Manikandan and P. Balakrishnan, "Automatic Ration Material Distributions Based on GSM and RFID Technology", *International Journal of Research in Communication Engineering*, Vol. 2, No. 2, June 2013
- [11]Xiaoya Guo , Emily Huang, Benson Hung ,Lara Juras. "Dimensionality Reduction and Classification of

Colour”<http://www.ece.uvic.ca/~bhung/399/index.html> March-2013

[12] Luís Cachuloa,b Carlos Rabadãoa, Telmo Fernandes “ Intelligent System for Grading of Jatropha Fruit by Its Feature Value Extraction Using Fuzzy Logics” *International Conference on Health and Social Care Information Systems and Technologies*, May-2013

[13] Mr. Prafull D. Patinge, “Fruit Detection with Multiple Features using Fuzzy Logic ” *International Journal of Advanced Research in Computer and Communication Engineering Vol. 1, Issue V, nov 2013*

[14] R. Ramachandran “Percentage Purity of Rice Samples by Image Processing” *International Journal of Soft Computing and Engineering (IJSCE) ISSN: 2231-2307, Volume-2, Issue-3, 2013*

[15] Ankita Mishra1, Jyoti Solanki, “Automatic Vegetable Recognition System” *International Journal of Advanced Research in Computer and Communication Engineering Vol. 1, Issue 8, Dec 2013*

[16] Sudha Bhalekar, Adesh Chanageri G., Indra Prakash Chauha, “Infected Fruit Part Detection using K-Means Clustering Segmentation Technique” *International Journal of Computer Technology and Electronics Engineering (IJCTEE) Volume 3, Special Issue, Dec- 2013.*

Thermal Imaging in Electronics: A Review

Ketali Patil¹, A. D. Vishwakarma², Shafique Ansari³, D. P. Marathe⁴, B. N. Bansode⁵

¹ PG Scholar (VLSI & ESD),^{3,4,5} Assistant Professor,² Associate Professor

^{1,2,3,4} Dept. Of E&TC Engg, GF's Godavari College of Engineering, Jalgaon, Maharashtra, India. Pin-425001
⁵ Electronics Engineering dept., Amrutvahini College of Engineering, Sangamner, Maharashtra
²anil_karma@yahoo.com

Abstract - Thermal imaging was made possible by the discovery of infrared energy over two centuries ago. Thermal imagery is the use of specialized equipment to detect infrared energy and create images out of tiny differences in that heat. As the security industry continues to advance, many avenues now require more sophisticated methods in order to provide a higher degree of surveillance. And this includes the ability to see in areas containing very little or no light, or areas of extreme contrast that make it very difficult to distinguish between good and bad.

Keywords – thermal imaging, infrared energy, surveillance, contrast

INTRODUCTION

Thermal imaging is a technique which is used to measure the working temperature of electronic device. There are two methods of measuring thermal resistance. First, there is an increased awareness of the importance of thermal design brought about by increased power densities and secondly the development of relatively cheap computers that can be used in the process of data acquisition, processing and display.

LITERATURE SURVEY

The technology of thermal imaging of electronic devices with low surface emissivity which uses an infra-red scanning imager to map the surface

temperature of electronic devices and circuits . Technique of measurement is to mount the device to be tested on a temperature controlled heat sink and measure the radiation emitted from the surface at one or more elevated temperature. These data are used to produce an emissivity map of the surface. The sample is then cooled to an appropriate temperature and energized and then a further measurement is performed. This final measurement and the emissivity map are then used to work out the temperature over the device surface. In this technology system has software to allow the two dimensional Fourier transformation of the results, low pass spatial filtering, which is followed by the inverse process. All the measurements are displayed as isometric projections[1].

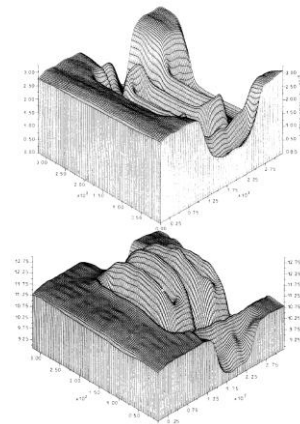

Fig. 1 Emissivity of gallium arsenide MOSFET
Fig. 2 Measured thermal distribution for the factor $F = 0$

Implementation of electronics module of a thermal imaging system in VLSI [2]. Thermal Imaging [2][3] is essentially an Infra-red Imaging based on plank's law of radiation which states that everybody radiates energy depending on its temperature [2]. The radiated energy is a nonlinear function of wavelength of radiation. Radiations in the spectral band of 3-14 μm suffers minim in attenuation in the atmosphere as compared to remaining spectrum of radiation emanating from an object.[2] This is the spectral band of interest in thermal Imaging. In this spectral band, there are two transmissive windows namely 3-5 μm and 8-14 μm . Large number of thermal imaging systems have been built around these windows. Commonly used materials for Infra-red detectors [4]-[7].

ELECTRONIC SUBSYSTEMS: The integral part of the thermal imager is the processing electronics [8] which is given below:

PREAMPLIFIERS: The signal output from the IR detector is in micro volt range. Low noise preamplifiers are used in detector proximity to amplify the signal to milli volt level [2].

ANALOG PROCESSING: Analog processing includes the further boosting up the video signal, individual channel gain adjustment to compensate for responsivity variations across the elements of the array, low pass and high pass filtering of detector preamplifier output as per system requirement and electronic multiplexing to convert sixty parallel output from detector into a single line video[2].

TIMING & CONTROL SIGNALGENERATION: This modules generates the various sync and blanking pulses for the display, address bits for the multiplexer, synchronization of horizontal timings with the scanner and video data

acquisition through multiplexers with interlace and display.[2]

OTHER ELECTRONICS MODULES: Besides this, FOV changeover and focussing electronics for scanner drive motor control electronic is also used [2]. Methodology for designing and implementing the controller for a thermal imaging system from the hardware description languages (HDLs) such as Verilog and VHDL ,control signal generation module of thermal imaging system with Xilinx FPGA.[2] Single-Shot Nanosecond Thermal Imaging of Semiconductor Devices Using Absorption Measurements[9]. A nonscanning optical method for single-shot thermal imaging of semiconductor devices is presented [9]. This method detects changes in the band-to-band absorption due to local self-heating effects and that device is illuminated from the substrate side and the image reflected from the device topside is detected[9]. The time resolution is 5 ns, determined by the laser pulse width and the space resolution is about 2m.This method is applied to study the transient current distribution in electrostatic discharge protection devices fabricated in smart power technology[9]

The method allows a fast analysis of the current-flow homogeneity in ESD protection and power devices[9].Miniaturization of Electrostatic Fluid Accelerators[10] Existing thermal-management methods for electronics and remain a major bottleneck in the evolution of computing, sensing, and information technology. The decreasing size of microelectronic components and the resulting increasing thermal output density require novel cooling solutions[10]. Electrostatic fluid accelerators (EFAs), also known as electro hydrodynamic ionic wind pumps, have the potential of becoming a critical element of electronic thermal- management solutions[10] Corona-induced air velocities from 1 to 10 m/s and electrical to kinetic energy conversion efficiencies from 0.05% to 7.5% have been reported [11]–[13]. Comprehensive reviews and tutorials on

this subject are readily available [14], [15]–[21] Electrostatic fluid accelerators (EFAs), also known as electro hydrodynamic ionic wind pumps, have the potential of becoming a critical element of electronic thermal management solutions[10].

Infrared – Imaging Analysis two experimental setups were used as we can see in the figures 3 and 4. And one was to determine the active region of the cantilever corona electrode, and another was to demonstrate the forced- Fig. 4 Picture taken in low-light condition showing the active corona discharge region of the cantilever corona electrode and its resulting ion stream convection-cooling effect of the cantilever-to-plane EFA [10].

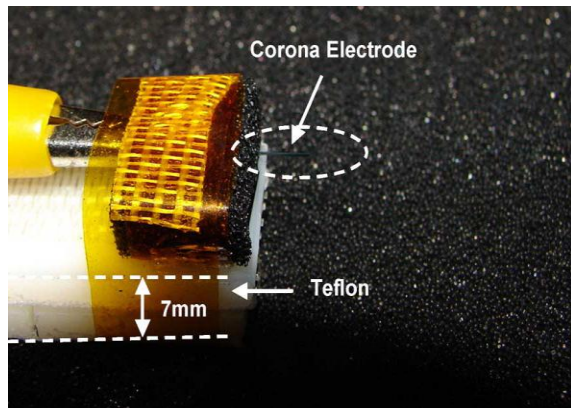

Figure 4 : the active region of the corona electrode of a single cantilever-to-plane EFA.

And the future work will be focus on other miniaturization and device integration into optimized thermal exchange structures e.g., heat sink channels. And that will be use of nanoscale emitter tips for field emission- based ionization and improved modeling of micro- EFAs will also be investigated [10]. Transient Thermal Imaging Using Thermo reflectance [21]. In this thermo reflectance imaging has proven effective in obtaining thermal images of active electronic and optoelectronic devices with submicron spatial resolution and 10- 50mK

temperature resolution. Thermo reflectance systems that use a lock-in method capture the steady state thermal signal but provide limited information about the thermal transient[21] Presenting a simple time series thermo reflectance method based on pulsed box-car averaging and a novel differencing technique to obtain transient thermal images with millisecond and microsecond time resolution and submicron spatial resolution. The full thermal transient pattern is reconstructed and captured in a charge coupled device (CCD) camera in a matter of minutes. Images are presented of the time evolution of the thermal signals on 40x40, and 100x100 micron square gold heaters [21].

Below figure shows Figure 5 shows the general timing for a pulsed boxcar average to obtain the transient thermal image. For each exposure of the CCD there is one LED pulse, effectively reducing the camera exposure to the time duration of the LED pulse width [21]. The figure depicts a boxcar average of 6 frames for each thermal cycle of the device excitation. For the next integration period of the CCD, the phase between the LED pulse and the device excitation is advanced by a small, known amount. Thus, the in-between data points are filled in by combining multiple boxcar averages. Thermo reflectance imaging is a proven effective non contact, non-destructive thermal characterization method that is based on the very small ($\sim 10^{-4}$) temperature dependence of material reflection coefficients. Temperature resolution to 10-50 mK has been demonstrated using this method [22-29]. Because thermo reflectance imaging uses visible light (e.g.470nm)[21]

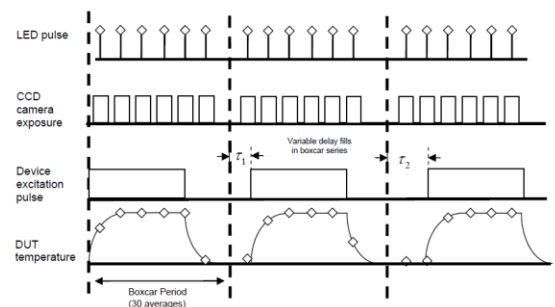

Figure 5: Timing diagram depicting 'pulsed boxcar' averaging scheme

Fast Transient and Steady State Thermal Imaging of CMOS Integrated Circuit Chips Considering Package Thermal Boundaries [30]. Shows the results of a transient and steady-state thermal imaging, using an infrared (IR) imaging system and thermo reflectance (TR) imaging for comparison [30]. Experiments, carried out on a wire-bond package and a flip-chip package of a CMOS thermal test chip, both chips share an array using the same unit cells, each containing heaters and diode sensors. And this to identify a local heating spot on a chip, spatial resolution of the thermal image is a main limiting factor. While, visible light achieves 200-300nm spatial resolution with thermo reflectance [21][30]. For the transient response, IR cameras provide crude spatial resolution given by the video frame rate. Thermo reflectance imaging can provide a full field mega pixel transient thermal image with wide dynamic range from 100ns up to 10's of milliseconds [30].

Conclusion

Thus, I have observed that the thermal imaging techniques in electronics such as acoustic micrography imaging, thermal imaging of electronic devices with low surface emissivity, transient thermal imaging using thermo reflectance, etc they are working still working on the methods in micrography and electronics devices, modules. And they have some results about the compares infrared and thermo reflectance thermal images and micrography verified that results with different modules. Some work has been done on these thermal imaging electronics technologies and we are still searching more methods to make it easy. Therefore

we can assume that there is an improvement in this technology.

References:

- [1] P.W. Webb, PhD, C Eng, MIEE "Thermal imaging of electronic devices with low Surface emissivity" IEEE PROCEEDINGS-G, Vol. 138, No. 3, JUNE 1991
- [2] AJAY KUMAR GARG, PRABHAKAR MORE and P NIJHAWAN "VLSI IMPLEMENTATION OF ELECTRONICS MODULE OF A THERMAL IMAGING SYSTEM" 1999 IEEE TENCON
- [3] J.M.Lloyd, "Thermal Imaging Systems", Plenum Press, New York, 1975.
- [4] R.D.Hudson, "Infrared Systems Engineering", John Wiley, New York, 1969.
- [5] W.S.Chan, "Advances in Focal Plane Technology", Proc SPIE, Vol. 217, 1990.
W.S.Chan, "MOSAIC Focal Plane Methodologies", Proc SPIE, Vol. 244, 1980.
- [6] J.T Wotherspoon, R.J.Dean, M.D.John, . Ashley, C.T. Elliott and A.M.White, "Development of SPIRTE Infrared Detectors", Proc SPIE Vol. 510, 102-112, 1984.
- [7] J Rose, Abbas El Gamal and A Sanjiovanni Vincentelli, "Architecture of Field Programmable Gate Array", Proceeding of the IEEE Vol 81, No 7, July 1993.
- [8] "Design Document of Thermal Electronics", Instruments Research and Development Establishment, Dehradun, report on thermal imaging system.
- [9] Dionyz Pogany, Viktor Dubec, Sergey Bychikhin, Christoph Furbock, Martin itzenberger, Sergey Naumov, Gerhard Groos, Matthias Stecher, and Erich Gornik "Single-Shot nanosecond Thermal Imaging of Semiconductor Devices Using Absorption Measurements" IEEE TRANSACTIONS ON DEVICE AND MATERIALS RELIABILITY, VOL. 3, NO. 3, SEPTEMBER 2003
- [10] Chih-Peng Hsu, Student Member, IEEE, Nels E. Jewell-Larsen, Student Member, IEEE, Igor A. Krichtafovitch, Stephen W. Montgomery, J. Ted Dibene, II, Member, IEEE, and Alexander V. Mamishev, Senior Member, IEEE "Miniaturization of Electrostatic Fluid Accelerators" JOURNAL OF MICROELECTROMECHANICAL SYSTEMS, VOL. 16, NO. 4, AUGUST 2007
- [11] H. Bondar and F. Bastien, "Effect of neutral fluid velocity on direct conversion from electrical to fluid kinetic-energy in an

- electro-fluid-dynamics (EFD) device," J. Phys. D, Appl. Phys., vol. 19, no. 9, pp. 1657–1663, Sep. 1986.
- [12] C. A. Belhadj, M. H. Shwehdi, A. S. Farag, F. M. Zedan, and U. K. A. Klein, "Experimental measurement of corona discharge using laser Doppler velocimetry," in Proc. IEEE Int. Symp. Elect. Insul., 1998, vol. 2, pp. 503–506.
- [13] N. E. Jewell-Larsen, "Optimization and miniaturization of electrostatic air pumps for thermal management," M.S. thesis, Dept. Elect. Eng., Univ. Washington, Seattle, 2004.
- [14] F. W. Peek, Dielectric Phenomena in High Voltage Engineering. New York: McGraw-Hill, 1929.
- [15] A. Castellanos, Electrohydrodynamics. New York: Springer-Verlag, 1998
- [16] J. S. Chang and A. Watson, "Electromagnetic hydrodynamics," IEEE Trans. Dielectr. Electr. Insul., vol. 1, no. 5, pp. 871–895, Oct. 1994.
- [17] F. Hauksbee, Physico-Mechanical Experiments on Various Subjects. New York: Johnson Reprint Corp., 1970.
- [18] L. B. Loeb, Fundamental Processes of Electrical Discharge in Gases. New York: Wiley, 1939.
- [19] M. Robinson, "Movement of air in the electronic wind of corona discharge," AIEE Trans., vol. 80, no. 54, pp. 143–150, May 1961.
- [20] O. M. Stuetzer, "Ion drag pressure generation," J. Appl. Phys., vol. 30, no. 7, pp. 984–994, Jul. 1959
- [21] K. Maize, J. Christofferson, A. Shakouri "Transient Thermal Imaging Using Thermoreflectance"
- [22] Christofferson, J., D. Vashae, A. Shakouri, P. Melese, "High Resolution Non-contact Thermal Characterization of Semiconductor Devices," Proceedings of the SPIE, vol. 4275, San Jose, CA, USA, p.24-25 Jan. 2001 p.119-25.
- [23]. Kaytaz, G., P. L. Komarov, and P. E. Raad, "A New Simulation Model of Electrothermal Degradation for MOSFET Devices Subjected to Hot Carrier Injection Stress," in Proc. 9th Int. IEEE Workshop THERMal INvestigations IC Systems (THERMINIC'03), Aix-en-Provence, France, Sep. 24–26, 2003, pp. 251–256.
- [24]. Christofferson, J., D. Vashae, A. Shakouri, P. Melese, X. Fan, G. Zeng, C. Labounty, J. E. Bowers, E. T. Croke III, "Thermoreflectance Imaging of Superlattice Micro Refrigerators," Seventeenth Annual IEEE Semiconductor Thermal measurement and Management symposium, San Jose, CA, USA, p. 20-22 March 2001.
- [25]. Goodson, K.E., Y. S. Ju, "Short-Time-Scale Thermal Mapping of Microdevices Using a Scanning Thermoreflectance Technique," Trans. of the ASME, p.306-313, May 1998.
- [26]. Quintard, V., S. Dilhaire, T. Phan, W. Claeys, "Temperature Measurements of Metal Lines Under Current Stress by High-Resolution Laser Probing," IEEE Transactions on Instrumentation and Measurement. Vol. 48, no. 1, pp. 69-74. Feb. 1999.
- [27]. Grauby, S., B. C. Forget, S. Hole, and D. Fournier, "High Resolution Photothermal Imaging of High Frequency Phenomena Using a Visible Charge Coupled Device Camera Associated With A Multichannel Lock-In Scheme," Rev. Sci. Instrum. 70, 3603 (1999).
- [28]. Ju, Y. S., K. E. Goodson, "Short-time-scale Thermal Mapping of Microdevices Using a Scanning Thermoreflectance Technique," Journal of heat transfer, vol. 120, no2, pp. 306-313, 1998.
- [29]. Bian, Z., J. Christofferson, A. Shakouri, P. Kozodoy, "High Power Operation of Electroabsorption Modulators," Appl. Phys. Lett., vol. 83, no. 17 pp. 3605-3607, 2003.
- [30] Kazuaki Yazawa , Dustin Kendig , James Christofferson , Amy Marconnet , and Ali Shakouri " Fast Transient and Steady State Thermal Imaging of CMOS Integrated Circuit Chips Considering Package Thermal Boundaries" 978-1-4244-9532-0/12 2012 IEEE,

A Survey of Advertising & Digital Marketing on performance of Indian Telecomm Industries

Ulka Nehete¹, Pallavi Nehete², Vijay D. Chaudhari³, Vilas U. Ubale⁴

¹ founder Entrepreneur, ² Co-founder Entrepreneur, ³ Ph.D. Scholar, ⁴ Asso. Prof.

^{1,2} NeheTech Digital Solutions LLP, Bavdhan budruk – Pune. Pin-411021. Maharashtra, India.,

⁴ Electronics Engg dept, Amrutvahini College of Engineering, Sangamner, Maharashtra

³ Electronics Engineering, North Maharashtra University, and Assistant Professor, GF's Godavari College of Engg, Jalgaon Pin-425001, Maharashtra, India.

¹ ulkanehete@gmail.com website: www.nehetech.com ³ vinuda_chaudhari@yahoo.co.in

Abstract – The marking communication activities are advertising and sales push –up that promotes the sales of Telecomm companies. The advertising sale & sales push-up study will assist telecomm to predicts other advertise spend and sales push-up expenses. Due to increasing use of Internet or Web, digital marketing can employ variety of digital channels such as mobile phones, wireless communications and digital TV. These increased digital media marketer need to ensure about improving their potential. A digital marketing can be uncertain due to its internal & external uncertainty & complexity of interaction. To improve the efficiency of advertising through digital marketing, a hybrid/integrated view is used which strengthen various decision support technique.

Now a days, children and teenagers are surrounded with the environment of digital media like instant messaging, mobiles, interactive games, online videos in their personal and social use. A large infrastructure of advertising agencies improves use of smartphones so mobile marketing companies reached to peoples easily. Fast food, snacks and soft-drink companies targeted the children. There is a need of improved evaluation metrics and lack of smart future proofing for reduction in skill gaps which is the current challenge in communication industry.

There is a try held to remotely manage smart advertising system designed using Raspberry pi

along with python programming. This system is very efficient to provide advertising information, to those people who live in public areas but; some areas that does not convenient to build- up the other types of advertise hoarding boards for their information. The system will consume a smaller amount of power and become the system smartness. The main goal is to study broadcasting information and remotely controls it. The information can be broadcast to buses and bus station, train and train station, shopping malls, city square, highways, subways, hospital, in conference hall along with educational institutes like colleges and schools for the purpose of displaying notices for students and also displaying all institutional growth and achievements information for visitors.

It has been tried here to review the impact of advertising and marketing of the product through Internet i.e. digital marketing on the consumer, retailer, and sale of product digitally. A review of comparative study of various aspects of digital marketing over advertising is mentioned.

Keywords: advertising, digital marketing, communication industry, mobile devices, intelligent decision support

INTRODUCTION

The Indian Telecomm sector is highly growing, on 2nd rank in the world. India also has largest users the

second largest telecommunications network in the world on the basis of the total sum of users for fixed and mobile telephone services². The main sectors in the telecommunication market of India are Internet, Telephony, and Television broadcast. As a result of market liberalization post 1990, large population base backed by increasing demand and huge development potential of the country, the Indian telecom sector has attracted many players making the competition very stiff in this sector^{3, 4}. The major Indian telecom companies are Idea, Bharti Airtel, Vodafone, Reliance Communications, Reliance Industries Ltd, Aircel, BSNL, MTNL, Tata, Telenor, Sistema, Videocon, and Quadrant. It is very essential for telecomm operator to be at the top of consumer mind. television channels, we will find the advertisement of any one or the other telecom company being showcased on the channel. Advertising and Sales promotion have always been a major marketing expense for all telecom organizations.

LITERATURE SURVEY

The Web-based hybrid knowledge automation system, called WebDigital, for formulating digital marketing strategies. Within this system, various digital marketing strategy models are computerized, adapted and extended. On-line Monte Carlo simulation is employed to capture the stochastic behavior of relevant factors or variables influencing digital marketing decision making. Web-based fuzzy logic is applied to model the uncertainty surrounding the input and strategic options. On-line "IF-THEN" rules are created to represent and automate associated planning knowledge and guidelines. Web databases are used to pass data amongst different functional components, and store and retrieve simulation results and user entries. The system has been tested using digital marketing cases with involved managers. Evaluation findings indicate that the Web-enabled knowledge automation system is efficient and effective in improving the digital marketing strategy formulation process and its output. [1].

Today's children and teens are growing up in a ubiquitous digital media environment, in which mobile devices, instant messaging, social networks, virtual reality, avatars, interactive games, and online video have become ingrained in their personal and social experiences. A large infrastructure of market research firms, advertising agencies, trend analysis companies, and digital strategists is continually monitoring how children and teens engage with new media. The exploding popularity of social media and the emergence of marketing strategies designed for those popular networks have made young people particularly vulnerable to interactive advertising. The rise of smartphones and elaborate mobile marketing campaigns has proved especially effective in reaching young people, as have interactive games and other immersive media. In the hands of fast-food, snack-food, and soft drink companies that target children and adolescents, the new marketing landscape raises particularly critical issues in light of the current obesity crisis. Internet usage continues to explode across the world with digital becoming an increasingly important source of competitive advantage in both B2C and B2B marketing. [2].

A great deal of attention has been focused on the tremendous opportunities digital marketing presents, with little attention on the real challenges companies are facing going digital. In this study, we present these challenges based on results of a survey among a convenience sample of marketing executives around the globe. The results reveal that filling "talent gaps", adjusting the "organizational design", and implementing "actionable metrics" are the biggest improvement opportunities for companies across sectors [3].

The research aims to specify any digital marketing skills gaps encountered by professionals working in communication industries. In-depth interviews were undertaken with 20 communication industry professionals. The challenge of integrating digital marketing approaches with established marketing practice emerges as the key skills gap. The research concludes that guidance on best practice, focusing upon evaluation metrics, future-proofing and

strategic integration needs to be developed for the communication industry. The Digital Marketing Model should be subject to further testing in industry and academia. Digital Marketing and social media need to be central to any marketing approach. The digital marketer model is mentioned in figure 1 below that summarizes answers to specific in interview questions.

– an issue already identified by industry. The main problem facing the communication industries is the lack of an integrated strategic approach to digital marketing, leading to a piecemeal approach to the use of digital marketing techniques.. There are individual challenges facing public and private sec-tor professionals due to differing uses of social media and digital marketing; while the private sector primarily adopts digital marketing as an extra communication channel for promoting and selling products and services for clients, public sector use is primarily focused upon information sharing and encouraging user engagement research. The current research adopted an exploratory approach, probing the use of digital marketing across a range of businesses within the communications sector i.e. both public and private sectors; organizations of differing sizes; communication experts across public relations, advertising and the creative industries. Future research might undertake a quantitative survey in order to probe these findings across a wider tranche of the communications industry. Future research should test the Digital Marketer Model with other industry employees, outside the communication and creative industries. Plans are being developed to test the Digital Marketer Model with teachers in the field of Higher Marketing Education in order to establish whether the model is a fair representation of a rounded digital marketing specialist. [4].

“Social Media is a group of Internet-based applications that build on the ideological and technological foundations of Web 2.0, and that allow the creation and exchange of User Generated Content”. There are few suggestions for mobile media applications given in figure 2.

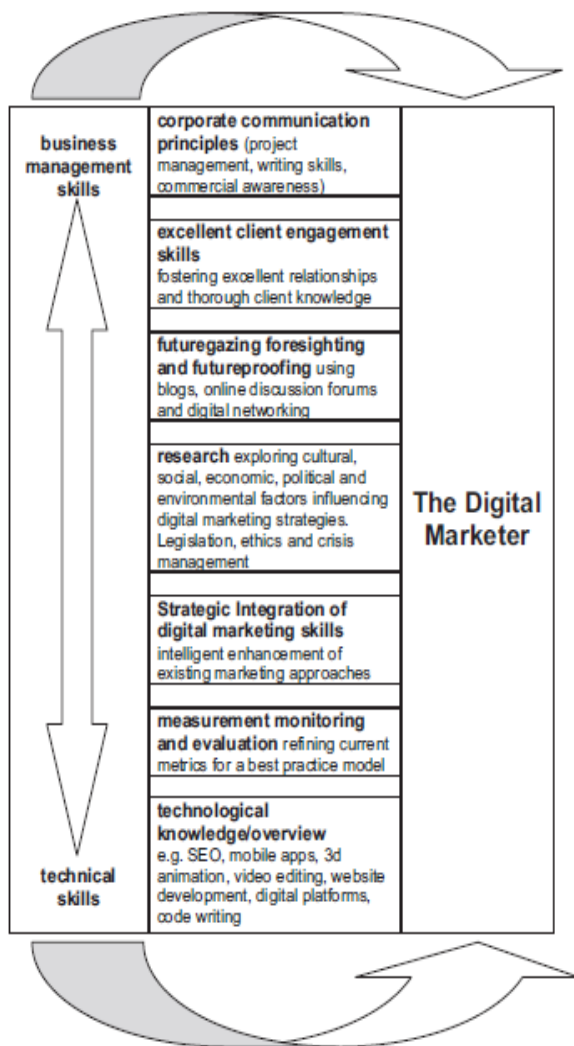

Fig. 1 Model for Digital Marketers [4]

The research probes how communication companies are using digital marketing skills as well as the challenges which need to be addressed. While the research identified some specific technical skills gaps

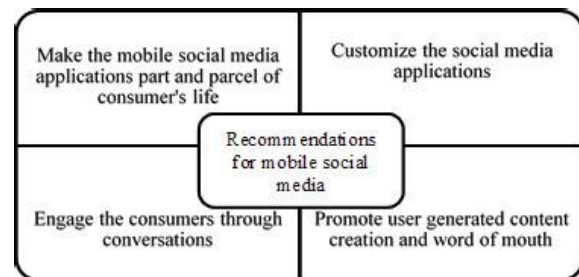

Fig. 2 Mobile media applications [5]

Keeping social media definition and mobile marketing into consideration, we define mobile social media as all Mobile marketing applications that enable the formation of user generated content [5]. Companies using mobile social media are often equipped with some information about consumers they are dealing with. Also, generally consumers agree to get knowledge from the company. It is necessary for firms entering the mobile social media world and planning to employ it in its marketing communications, have to move very cautiously keeping in mind all the rules and regulations of the game. The company has to be more cautious in case of mobile social media as compared to other conventional media because of the vulnerability of brand equity through User Generated Content.

The paper puts on the basis of idea which focuses on cost reduction and enhancing the quality of service in the field of digital advertising technologies. This work is about a remotely managed smart advertising system designed using Raspberry pi along with python programming. The digital advertising display system designed is based on various methods of using LCD screen, as well as other display devices. This system is very efficient to provide advertising information, to those people who live in public areas but; some areas that does not convenient to build- up the other types of advertise hoarding boards for their information. The Raspberry Pi model and its web interface using Wi-Fi dongle. This proposed system aims to substitute another system interface with Raspberry Pi, which will not only drastically reduces the cost involved but also will help achieving quality of services as the system will consume a smaller amount of power and become the system smartness. he work on "smart advertising technology using remote controlled raspberry pi" has been successfully designed and tested it by uploading and deleting of the still images and the moving images files that is in the MP4 format and also remotely access it by using Wi-Fi network from remote places.

The aim of this thesis is to design and implement a digital advertising system that is remotely accessible and manageable very smart manner. The technology with Python has been implemented together on Raspberry Pi and webserver to achieve the desired result. The content management system of the digital advertising of still and moving images is designed with focus on managing the content distribution on

the public transport industry. In this system each display screen can be remotely managed and controlled via web interface. The approach of controlling the display system via a web interface over the internet could be useful for implementation of other similar applications that require remote access and monitoring. It has been developed by integrating features of all hardware components and software used. The presence of every module has been reasoned out and placed carefully thus contributing to the best working of the unit. Secondly, using highly advanced ARM11 raspberry Pi B+ board and with the help of growing technology the project has been successfully implemented.

The designed system for advertising purpose with full potential of digital advertising is an innovative, interactive medium, as compared to other traditional and static media.

As a part of a future work,

1) Cloud-based digital advertising:

The cloud computing has been seeing a wide area of applications in the market of digital advertising if start the advertising on the basis of payable per hour of use or number of operations. Then it becomes a reliable and cost efficient and can be deployed rapidly on digital advertising networks of any size.

2) Security:

Security is a very important part of any system, and in the digital advertising system improving the system smartness, security facility by giving the option of user login and user password for uploading the advertising on paying basis.

3) Increasing the pervasiveness and interactivity:

The way of increasing interactivity via the mobile device: with almost six billion mobile cellular subscriptions in worldwide and many of them including access to high-speed 3G services. The most of the handsets having features at least some basic interfaces, including SMS, and short-range Radio communication technologies such as Bluetooth and NFC. Then from handset it can trigger to event on the display such as uploading and deleting an advertising file [6].

Collectively this article shed light from many different angles on how consumers experience, influence, and are influenced by the digital environments in which they are situated as part of their daily lives. Much is still to be understood, and existing knowledge tends to be disproportionately focused on WOM, which is only part of the digital

consumer experience. Consumers' behaviors other than those related to online WOM/reviews should be considered, and other types of information found (and inferences made) in online environments should be considered. For example, it would be interesting to consider the complex interplay between transmitter, receiver, linguistic/content, and context factors when it comes to antecedents and consequences of online WOM. Another high-potential direction for future research is to consider how various kinds of digital environments (including social media and mobile) impact a wide variety of consumer outcomes, including psychological and economic constructs [7].

The author described a framework for research in a particular segment of digital advertising. Internet Advertising [8] Paid Slots and Spaces (IAPS) is a neologism and work almost like a stock exchange for buying and selling advertising in various formats on designated spaces around web and make a significant contribution to Internet advertising revenues. Given the complexity of the modern digital advertising eco system, this literature review seeks to provide clarity, up-to-date knowledge and ongoing insights into Internet advertising channels, for managers making investment decisions in this context. Advertising overview for sponsored search is given in figure 3.

These paid spaces were found to encompass diverse areas of Internet advertising that include search engine marketing, social media advertising and display advertising.

CONCLUSION

There is a significant predictive advertising spends with sales performance of telecom companies. The prediction of sales revenue for varying amounts of advertisement spent and promotion spent can be revised. The model can be useful for better forecasting of advertising and digital marketing of push-up of sales and promotions expenditure.

REFERENCES

[1] Shuliang Li a, Ji, Jim Zheng Li b, Hong He c, Philippa Ward d, Barry J. Davies d, "WebDigital: A Web-based hybrid intelligent knowledge automation system for developing digital marketing strategie", *Expert Systems with Applications* 38 (2011) 10606–10613.

[2] Kathryn C. Montgomery,, Jeff Chester,b,, Sonya A. Grier,, Lori Dorfman, "The New Threat of Digital Marketing", doi:10.1016/j.pcl.2012.03.022, Elsevier Inc.

[3] Peter S.H. LeeFlang a,b, Peter C. Verhoef a, Ji, Peter Dahlström c, Tjark Freundt, "Challenges and solutions for marketing in a digital era", *European Management Journal* 32 (2014) 1–12.

[4] Jo Royle, Audrey Laing, "The digital marketing skills gap: Developing a Digital Marketer Model for the communication industries," *International Journal of Information Management* 34 (2014) 65–73.

[5] Mayank Yadava, Yatish Joshib, Zillur Rahman, "Mobile social media: The new hybrid element of digital marketing Communications," *Procedia - Social and Behavioral Sciences* 189 (2015) 335 – 343.

[6] Umakant B. Gohatre, Mr. Vijay D. Chaudhari, Dr. K. P. Rane, , "Rasp-Pi based Remote Controlled Smart Advertising of Still and Moving Images," *International Journal Of Engineering And Computer Science* ISSN: 2319-7242, Volume 4 Issue 9 Sep 2015, Page No. 14449-14457.

[7] Andrew T Stephen, "The role of digital and social media marketing in consumer behavior", *Elsevier Current Opinion in Psychology* 2016, 10:17–21.

[8] Bilal Aslam, Heikki Karjaluo, "Digital Advertising around Paid Spaces, E-Advertising Industry's Revenue Engine: A Review and Research Agenda," *Telematics and Informatics* (2017), <http://dx.doi.org/10.1016/j.tele.2017.07.011> .

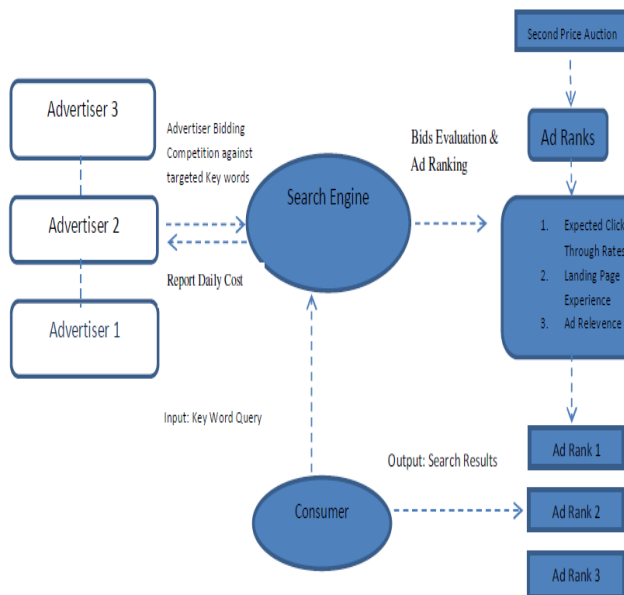

Fig. 3 Sponsored search advertising overview [8]

CSE-01 Public Cloud For Academic Stuff

Reshma Attarade, Chetna Savdekar, Jagruti Badgujar, Kartik Malviya

*Student, C.S.E. Department, G.C.O.E. Jalgaon,
Prof. Pramod B. Gosavi
gosavi.pramod@gmail.com
HOD, C.S.E. Department, G.C.O.E. Jalgaon,*

Abstract - Public clouds are made available to the students by a service provider who hosts the cloud infrastructure. Generally, public cloud providers like Amazon AWS, Microsoft and Google own and operate the infrastructure and offer access over the Internet. With this model, customers have no visibility or control over where the infrastructure is located. It is important to note that all customers on public clouds share the same substructure group with limited formation, security protections and availability variances. Some peoples have their own collections like articles, document, video, audio, etc. They have not any way to present their collection they cannot present to general public. We Providing storage for students to sharing their educational data publicly, such as Pdf's, word document, Audio Video, Images.

Keywords – Cloud computing, services, Search engine, Server, Privacy, Virtual machine monitors.

I. INTRODUCTION

A public cloud can be defined as an emerging computer prototype where data and services reside in parallel scalable data centers in cloud and we can accessed these data from any connected devices over the Internet. Public cloud is a way of providing various services on virtual machines. And virtual machines allocated on top of a large physical machine pool which resides in the cloud. We have lots of compute power and storage capabilities which residing in the distributed environment of the cloud. The basis of public cloud is to create a set of virtual servers on the available huge resource

pool and give it to the clients. Through virtual servers any web enabled devices can be used to access the resources. Based on the client's need, the client can be scaled up or down the infrastructure.

In this type an organization rents cloud providers provides cloud services on-demand basis. Using utility computing model services provided to the users.. In traditional main stream public cloud or external cloud describes cloud computing. Public clouds are run by third parties, and applications from different customers are mixed together on the cloud's servers, storage systems, and networks. A public cloud provides some cloud services.

Public cloud is Internet-based computing, which shared resources, software, and Information are provided to computers and other devices on-demand basis.

Public cloud computing model is Internet based computing model where virtual shared servers provide software, infrastructure, platform, devices and other resources Users can access these types of services available on the "Internet cloud" without knowing -how on managing the resources involved. Therefore, to manage their business processes users can concentrate more on their core business processes rather than spending time and gaining knowledge on resources needed Customers of the public cloud do not own the physical infrastructure; rather they rent the usage from a third-party provider. This is helpful them to avoid huge.

Public Cloud customers benefit from economies of scale, because infrastructure costs are spread across all users. store the our data publically.

II. LITERATURE REVIEW

Cloud computing provides us that means we can access applications such as utilities, over the Internet. We can create, arrange and modify application online. Cloud computing users can access database resources through the Internet from anywhere and anytime.

Cloud computing offers to us online data storage, infrastructure and applications. Cloud computing is a combination of software and hardware.

2.1 Basic Concept :-

There are some services and models working behind making of cloud computing. And it is a feasible & accessible to end users. There are some working models for cloud computing are as follows:

2.1.1 Deployment Models:-

Deployment model is type of how to access cloud ? i.e how the cloud is located? There are four types of access cloud. i)Public ii) Private iii) Hybrid iv) Community.

Private Cloud :- The private cloud allows us to access the system & services within the organization.

Public Cloud :- The public cloud allows us to access the services in the general public.

Hybrid Cloud :- The hybrid cloud is the combination of public & private cloud whenever using public cloud non-critical activities are performed.

Community Cloud :- The community cloud allows us to access the system & services within the group of organization.

2.1.2 Service Models:-

Service models are reference models which is based on the cloud computing models. Service models are classified into three basic service models. i) Infrastructure as a Service(IaaS) ii) Platform as a Service(PaaS) iii)Software as a Service(SaaS)

III.PUBLIC CLOUD ARCHITECTURE



Fig: Architecture Of Public Cloud

The two most important components of cloud computing architecture are known as the front end and the back end. The front end is the part seen by the client, i.e. the computer user. This includes the client's network (or computer) and the applications used to access the cloud via a user interface such as a web browser.

The three fundamental classifications are often referred to as the SPI Model, where SPI refers to Software, Platform or Infrastructure (as a Service), respectively defined thus:

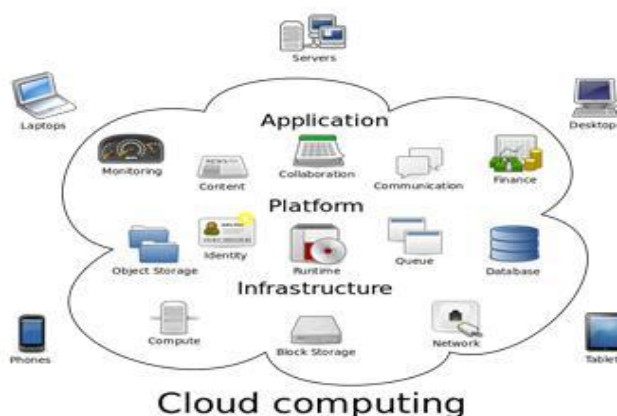

Fig: Public cloud services

Software as a Service (SaaS) : Software as a service (SaaS) is a software distribution model in which a third-party provider hosts applications and makes them available to customers over the Internet. software, you simply access it via the Internet, freeing yourself from complex software and hardware management. A SaaS has multitenant architecture, in which all users and applications share a single, common infrastructure and code base that is centrally maintained. Because SaaS vendor clients are all on the same. E.g. - Google App Engine. Examples are Microsoft Azure, Force and Google App Engine.

Infrastructure as service (IaaS): Infrastructure as a Service (IaaS) is a method of delivering computing, storage, networking and other capabilities via the Internet. IaaS enables companies to utilize web-based operating systems, applications and storage without having to purchase, manage and support the basic cloud infrastructure. The most popular examples of IaaS platforms include Amazon Web Services (AWS) and Microsoft Azure .

Platform as a Service (PaaS): Platform as a services is an application development and deployment platform delivered as a service to developers over the Web. This platform consists of infrastructure software, and typically includes a database, middleware and development tools. E.g. - Google App Engine. Examples are Microsoft Azure, Force and Google App Engine.

IV. PROPOSED SYSTEM

In this project we implements the some ideas providing some storage (space) to college students for upload and shares their data like articles, images or videos ,document, etc.

We Provide a cloud storage for students to share their educational data publicly. Generally, public cloud providers like Amazon AWS, Microsoft and Google own and operate the infrastructure and offer access over internet.

Public Cloud customers benefit from cost-cutting of scale, because infrastructure costs are spread across all users,

allowing each individual client to operate on a low-cost. public cloud infrastructures is that they are typically larger in scale than an in-house enterprise cloud, which provides clients with continuous, on-demand scalability. These clouds offer the greatest level of efficiency in shared resources; however, they are also more helpless than private clouds

Advantages:

- **Cost Saving :** The most important benefit one can get by using cloud computing is cost saving and especially this has work really well for small sized companies.
- **Reduced time for implementation :** Cloud computing provides the processing power and data storage as needed at the capacity required..
- **Dynamic scalability:** Cloud computing provides an extra processing buffer as needed at a low cost and without the capital investment
- **Reliability :** Services using multiple redundant sites can support business continuousness and disaster recovery.
- **Maintenance :** Cloud service providers do the system maintenance, and access is through application programming interfaces that do not require application installations onto PCs, thus further reducing maintenance requirements.
- **Mobile Accessible :** Mobile workers have increased productivity due to systems accessible in an infrastructure available from anywhere .
- **Less personnel training is needed :** It takes fewer people to do more work on a cloud, with a minimal learning curve on hardware and software issues . This result in less spending on infrastructure and company would spend more on their projects.
- **Minimize licensing new software :** Stretch and grow without the need to buy expensive software licenses or programs. Cloud does not require you to buy hardware and software

Disadvantage:

- **More elasticity means less control :** While public clouds are great for quickly topping up and down your resources, companies that require complete and total control over their data and applications will need to avoid the public cloud .
- **Not everything fits into the cloud :** Depending on the cloud provider, you may face limitations on available applications, operating systems, and infrastructure options.
- **Data Location :** Cloud computing technology allows cloud servers to reside anywhere, thus the enterprise may not know the physical location of the server used to store and process their data and applications..
- **Data Safety :** Application sharing and multi - tenancy of data is one of the characteristics associated with cloud computing. Data encryption is another control that can assist data confidentiality.
- **.Cloud date ownership :** In the contract agreements it may state that the CP owns the data stored in the cloud computing environment . The CSP may demand for significant service fees for data to be returned to the enterprise when the cloud computing S LAs terminates.

VIII. CONCLUSION

Demonstrate that students can store their educational collection on the cloud instead of on their own desktop pc's their own servers .Student can access file on cloud from any computer at anywhere.

Cloud Computing is outpacing the IT industry.

- Real business value can be realized by customers of all sizes .
- Cloud solutions are simple to acquire, don't require long term contracts and are easier to scale up and down as needed.

- Proper planning and migration services are needed to ensure a successful implementation.
- Public and Private Clouds can be deployed together to leverage the best of both .
- Third party monitoring services ensure customer are getting the most out of their cloud environment .
- Security Compliance and Monitoring is achievable with careful planning and analysis.

If you are considering using the cloud, be certain that you identify what information you will be putting out in the cloud, who will have access to the information, and what you will need to make sure it is protected.

Additionally, know your options in terms of what type of cloud will be best for your needs, what type of provider will be most useful to you, and what the reputation and responsibilities of the providers you are considering are before you sign up.

References

- [1] Lewis, Grace . Cloud Computing: Finding the Silver Lining, Not the Silver Bullet . <http://www.sei.cmu.edu/newsitems/cloudcomputing.cfm> (2009).
- [2] Lewis ,Grace .Basics about Cloud Computing .<http://www.sei.cmu.edu/library/abstracts/whitepapers/cloudcomputingbasics.cfm> (2010).
- [3] Jansen, Wayne & Grance, Timothy. Guidelines on Security and Privacy in Public Cloud Computing . National Institute of Standards and Technology, 2011.

Strowd, Harrison & Lewis, Grace. T -Check in System -of - Systems Technologies: Cloud Computing (CMU/SEI- 2010 - TN- 009). Software Engineering Institute, Carnegie Mellon University,2010.<http://www.sei.cmu.edu/library/abstracts/reports/10tn009>

CSE-02 Survey on a Secure Health Care Technology Based on BSD Care

Rajshri Surdas¹, Mayuri Kathade², Rupali Borole³, Kalyani Bagul⁴, Prof. Nilesh Chaodhry⁵

^{1 2 3 4} Student

⁵ Assistant Professor

cont.nilesh@gmail.com

GF's Godavari COE Jalgaon(MS), India, 425001

Abstract – Advances in data and communication technologies have diode to the coming out of net of Things (IoT). Within the latest thing health care atmosphere, the usage of IoT technologies brings convenience of physicians and patients since they're applied to varied medical areas (such as period observation, patient data management, and tending management). The body detector network (BSN) technology is one in every of the core technologies of IoT developments in attention system, where a patient area unit usually monitored employing a collection of small powered and lightweight wireless device nodes. However, development of this new technology in attention applications whereas not considering security makes patient privacy weak. Throughout this text, at first we have a tendency to tend to focus on the most important security desires in BSN based smart attention system. After, we have a tendency to tend to propose a secure IoT based tending system pattern BSN, called BSN-Care, which may with efficiency accomplish those desires.

Keywords- Data Privacy, Android, IOT, Security, BSN,

Classification, ECG

NOMENCLATURE TABLE

Sr. No.	Short Form	Description
1	IoT	Internet of Things
2	GPS	Global Positioning System
3	BSN	Body Sensor Network
4	SE	Self Encryption
5	API	Application Program Interface
6	SQL	Structural Query Language

7	RFID	Radio Frequency Identification
8	SDK	Software Development Kit
9	LPU	Local Processing Unit
10	ECG	Electrocardiograms

I INTRODUCTION

Internet of Things (IoT) has become one of the foremost powerful communication paradigms of the 21th century. inside the IoT atmosphere, all objects in our everyday of living become a vicinity of the online because of their communication and computing capabilities (including little controllers, transceivers for digital communication). IoT extends the construct of the online and makes it loads of enveloping. IoT permits not to be faulted interactions among different types of devices like medical detector, observance cameras, home appliances so on. Because of that reason IoT has become loads of productive in several areas like health care system. In health care system, IoT involves many sorts of low value sensors (wearable, implanted, and environment) that modification aged people to consider stylish medical health care services anywhere, any time. Besides, it to boot greatly improves aged peoples quality of life. The body detector network (BSN) technology is one of the leading very important technologies used in IoT-based stylish health care system. It's basically a crowd of low-power and lightweight wireless detector nodes that square measure comfortable monitor the frame

functions and around atmosphere. Since BSN nodes square measure familiar collect responsive (life-critical) information and will operate in hostile environments, consequently, they have strict security mechanisms to prevent malicious interaction with the system. The previous couple of decades have witnessed a regular increase in life in many parts of the world leading to a sharp go up inside the variability of aged people. A recent report from world organization foretold that there will be 2 billion (22% of the world population) older people by 2050. To boot, analysis indicates that regarding eighty 9 of the aged people square measure apparently to live severally. However, medical analysis surveys found that concerning eightieth of the aged people older than sixty 5 suffers from a minimum of 1 chronic sickness inflicting many aged people to possess issue in taking care of themselves. Consequently, providing associate honest quality of life for aged people has become a major social challenge at that moment. The speedy increase of knowledge and communication technology is facultative innovative health care solutions and tools that show promise in addressing the aforementioned challenges. Initial we have a tendency to tend to deal with the various security desires in BSN primarily based trendy health care system. Then, we have a leaning to tend to propose a secure IoT primarily based health care system unfair treatment BSN, referred to as BSN-Care, which could guarantee to with efficiency accomplish those desires.

II RELATED WORK

1. A Secure IoT-based Modern Healthcare System Using Body Sensor Network

Author: Prosanta Gope, Tzonelih Hwang

The body detector network (BSN) technology is one in every of the core technologies of IoT developments in tending system, wherever a patient may be monitored using a group of tiny-powered and light-weight wireless

sensor nodes. However, development of this new technology in tending applications while not considering security makes patient privacy vulnerable. Throughout this article, initially we have a tendency to highlight the major security needs in BSN based mostly stylish tending system. Afterwards, we have a tendency to propose a secure IoT based mostly healthcare system mistreatment BSN, known as BSN-Care, which can efficiently accomplish those needs [1].

2. Security Issues in Healthcare Applications Using Wireless Medical Sensor Networks: A Survey."

Author: P. Kumar, and H. Lee,

Healthcare applications are attention about as promising fields for wireless sensing element networks, wherever patients will be monitored unfair treatment wireless medical sensing element networks (WMSNs). Current WMSN health care analysis trends concentrate on patient reliable communication, patient quality, and energy-efficient routing, as some examples. However, deploying new technologies in health care applications while not considering security makes patient privacy in danger. Moreover, the physiological knowledge of a private are extremely sensitive. Therefore, security may be a preponderant demand of health care applications, especially within the case of patient privacy, if the patient has AN uncomfortable illness. This paper discusses the safety and privacy problems in health care application victimisation WMSNs. We highlight some common health care comes victimisation wireless medical sensing element networks, and discuss their security [2].

1. "Medical Monitoring Application for Wearable Computing"

Author: DEJAN RAKOVIC THOMOS MARTIN
AND
EMIL JOVANOVIĆ

In this paper we discuss system design issues, present a survey and sensors and introduce two taxonomies of medical monitoring applications for wearable computing [3].

2. "Untracable Sensor Movement in Distributed IoT Infrastructure"

Author: Prosanta Gope, Tzonelih Hwang

In this paper we tend to concentrate on the privacy of the device movement during a distributed IoT infrastructure. During this regard, initially we tend to propose a distributed IoT system design. Then, we tend to style a light-weight anonymous authentication theme, which may guarantee numerous security problems associated with privacy of the device node like obscurity, untraceability, replay attacks, DoS attacks, etc. so as to style the light-weight authentication framework for IoT, we are going to use the light-weight crypto logic primitives just like the hash perform and bitwise exclusive-OR, wherever these crypto logic primitives cause less machine overhead and fairly a lot of less execution time as compared to different crypto logic primitives like uneven encryption/decryption, modulo operation etc [4].

3. Transactional Confidentiality in Sensor Networks

Author: Samper Pai, Sergio Bermudez, and Stephen B. Wicker

The association for Standardization (ISO) defines confidentiality because the assurance that information is accessible solely to those approved to own access. Confidentiality is provided through policies and practices that make sure that info flows solely to approve people. in a very network, confidentiality requires the event of rules governing access to transactional knowledge (that is, the knowledge gathered through generation, transmission, and routing of information messages inside the network) and technical measures that enforce those rules and prevent adversary from violating them. In several cases, conserving network confidentiality could be a beginning in conserving the privacy of a detector network's users and deployers, and, where individual's are gift within the network area, their privacy and safety further [5].

1. Ubiquitous Monitoring Environment for Wearable and Implantable Sensors (UbiMon)"

Author: Jason W.P. Ng, Benny P.L. Lo, Oliver Wells, Morris Sloman, Nick Peters, Ara Darzi, Chris Toumazou, and Guang-Zhong Yang

Body device network (BSN) is associate degree helpful technology for providing present attention watching.

even with the technological developments of sensing and watching devices, problems associated with system integration, sensor efficiency, low-power device interface electronic equipment design, wireless links and signal process area unit major technical challenges. The aim of this paper is to address problems associated with victimisation wearable or implantable sensors for distributed mobile watching. A proposed system design, together with a initial expression prototype, is delineated [6].

III EXISTING SYSTEM

The last few decades have witnessed a delicate increase in life in many parts of the world leading to a quick rise among the vary of previous of us. A recent report from alignment predicted that there will be a try of billion (22% of the world population) older of us by 2050. In addition, analysis indicates that concerning eighty 9 of the aged of us square measure probably to live severally. However, medical analysis surveys found that concerning eightieth of the aged of us older than sixty 5 suffers from a minimum of 1 chronic health problem inflicting many aged of us to possess issue in taking care of themselves. Consequently, providing associate degree honest quality of life for aged of us has become a big

social challenge at that moment. The speedy proliferation of information and communication technologies is facultative innovative health care solutions and tools. In existing system security issues were a heavy disadvantage. Thanks to this lack of security, some patient's necessary data lost. It finally ends up within the weakness of the patient's privacy. To beat this disadvantage, some projected techniques square measure handled to require care of the data security.

DISADVANTAGES

1. System security issues
2. Digital Divide among Patients
3. Lack of Information Control
4. Safety and privacy

IV PROPOSED SYSTEM

The body device network (BSN) technology is one

in every of the core technologies of IoT developments in care system, wherever a patient are often monitored employing a assortment of tiny-powered and light-weight wireless device nodes. However, development of this new technology in care applications while not considering security makes patient privacy vulnerable. Here initially we tend to highlight the key security needs in BSN based mostly trendy care system. After, we tend to propose a secure IoT based mostly care system victimisation BSN, referred to as BSN-Care, which may expeditiously accomplish those needs. We tend to gift a listing of security parameters that area unit needed to be self-addressed in any IoT based mostly care system victimisation BSN. We tend to gift our BSN-Care system and after, we tend to conjointly therefore show the way to enforce security in our BSN-Care model to realize all the imperative security properties.

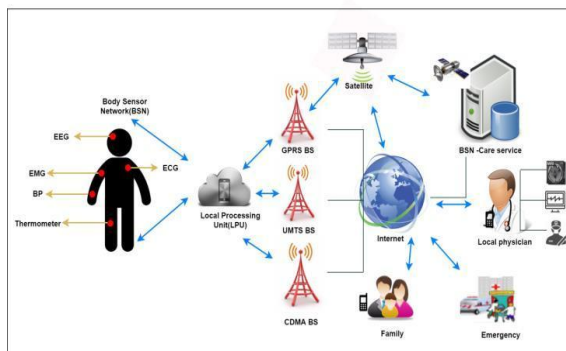

Fig 2: System Architecture

3

ADVANTAGES

1. Decreased Costs
2. Improved Outcomes of Treatment
3. Improved Disease Management
4. Reduced Error
5. Enhanced Patient Experience
6. Enhanced Management of Drugs

A ANDROID

Android could be a total set of code for mobile devices like pill computers, notebooks, sensible phones, electronic book readers, set-top boxes etc. It contains a Linux-based software, middleware and key mobile applications. It will be thought of as mobile software. However it's not secret to mobile exclusively. It's presently utilized in varied devices like mobiles, tablets, televisions etc.

B SQLITE

SQLite is RDBMS. SQLite is Associate in nursing in-process library that implements a self-contained, server less, zero configurations, transactional. It written in ANSI-C and provides easy and easy-to-use API. In distinction to several direction systems, SQLite isn't a client-server info engine. The ASCII text file for SQLite is publically domain. SQLite is ACID-complaint (Atomic, Consistent, Isolated and Durable), permitting safe access from multiple processes or threads. It's not a standalone method like various databases; you'll link it statically or dynamically as per your demand together with your application. It will access its storage files directly. A whole SQLite info is hold on in a very single cross-platform computer file. It's terribly tiny and lightweight weight, but 400KB absolutely designed. It's out there on OS (Linux, OS-X, Android) and Windows (Win32, Win RT, WinCE).

C MYSQL

MySQL is open source relational database management system (RDBMS) which is freely available and makes use of Structured Query Language. It was widely used open source client server RDBMS. It is one of the best RDBMS being used for developing web-based software applications. MySQL is developed, marketed, and supported by MySQL AB, which is Swedish company. It makes use of a standard form of the well-known SQL

4

data language. It has become popular because of its features. MySQL is released under an open-source license. So you need not require paying. It is capable of handling a large subset of functionality of the most expensive as well as powerful database packages. It is scalable and it has the ability to handle almost any amount of data. It is a secure database. It includes solid data security layers which protect sensitive data from intruders. It supports the several development interfaces

like JDBD, ODBC and scripting (PHP and Perl). It can be executed under a number of operating system.

VI PURPOSE

- Security is one of the most imperative aspects of any system.
- Various security threats to these systems. So implement key security requirements in IoT based healthcare system using BSN.

VII SCOPE

1. IoT based devices is mostly used now a days
2. Provide solution without extra hardware requirement
3. To develop an Android application that is cost efficient
4. To efficiently use of resources
5. To make system easy to handle and accurate

VIII CONCLUSION AND FUTURE SCOPE

In this Paper, initially we've got explain the protection and therefore the privacy problems in health care applications exploitation body device network (BSN). afterward, we tend to found that even supposing most of the favoured BSN primarily based analysis comes acknowledge the problem of the protection, however they fail to introduce robust security services that would be preserve patient privacy. Finally, we tend to projected a secure IoT primarily based health care system operation BSN, referred to as BSN-Care, which may expeditiously achieve various security needs of the BSN primarily based health care system.

IX CONTRIBUTION

- Family members having notification about patient Health day by day.
- And also doctor having notification about patient health like (Patient is normal or not any other changes occurred after treatment is also regularly check using smart devices).
- Patient Information Security and Patient Healthcare are smartly managed.
- IoT is most popular now a days so here satellite is available that maintain all record regarding to healthcare appliances.

X REFERENCES

1. Prosanta Gope, Tzonelih Hwang "BSN-Care: A Secure IoT-based Modern Healthcare System Using Body Sensor Network" – 2015
2. P. Kumar, and H. Lee, "Security Issues in Healthcare Applications Using Wireless Medical Sensor Networks: A Survey." Sensors (Basel, Switzerland) 12.1 (2012): pp. 55–91.
3. DEJAN RAKOVIC THOMOS MARTIN AND EMIL JOVANOVA "Medical Monitoring Application for Wearable Computing" Jul – 2003.
4. Prosanta Gope, Tzonelih Hwang "Untracable Sensor Movement in Distributed IoT Infrastructure" -2015
5. Samper Pai, Sergio Bermudez, and Stephen B. Wicker "Transactional Confidentiality in Sensor Networks" jul/Aug 2008
6. Jason W.P. Ng, Benny P.L. Lo, Oliver Wells, Morris Sloman, Nick Peters, Ara Darzi, Chris Toumazou, and Guang-Zhong Yang "Ubiquitous Monitoring Environment for Wearable and Implantable Sensors (UbiMon)" - 2010

CSE-03 Android Based Smart Attendance System

Miss.MadhuriZawar

zawarmadhuri0@gmail.com

Vishakha Dandage¹,Yogita Patil²,Ashwini Mahajan³,Shubhangi Sapkal⁴

¹Student, of computer dept Gf's GCOE, Jalgaon

Abstract:

An Education complex in India wil become so advanced in future due to the development of the internet based technical knowledge. Smart class, video conferencing are some of the examples of modern technology in educational system. These applications help the institute to move forward quickly, fulfil their vision and accomplish their goals, E-way. The kernelidea of research project have to implement Android based application for attendance management system for advancement of institution and education system. The proposal project will be implemene in applications such as online study material, notices,and online indicator of exam, online attendance record, achievement record, and parent intimation system using Android based applications. This system helps teacher to take attendance through smart phone and keep record of students for their progressive assessment. This system gives a ahead intimation to student as soon as their attendance goes down the detailed attendance threshold in the form of an SMS.

Keywords: *Android, Attendance management, E-learning, GPRS, smart phone, etc.*

I. INTRODUCTION

Nowadays, mobile devices have become approach of life for students particular in higher education. Computers are now replaced by compress smart mobile phones that can be fit into pocket and can be carried anywhere. The rapid progress in mobile technology has created a new area which is known as mobile learning. Mobile aquire information is the next generation of e-learning that leads attractive way of knowledge delivery especially used in teaching and learning process. With development of this Android application the

student preferred to use mobile devices as technology supported educational tool. This system is designed because notes dictation in the class is difficult considering semester duration, student might miss the exam and important notice show due to innocence, errorness marking of attendance is more due to more paper work and manual attendance entry, evaluation and report generation is tedious and delay job. Decades to parent are not accessible. With this system teacher can upload notes, time tables, assignment on server and broadcast it to the registered mobile numbers so that it is easily accessible to student by their own smart phone. This system enables student to learn anywhere, anytime and at their own advancement s. This system makes students to alive, responsive while learning their academic. Another application that is provided by this system is smart attendance evaluation and report generation. Smart phones are based on operating systems like blackberry, I OS and Android. To design proposed project, smart phones with Android operating system are chosen because penetration rate of Android OS is 70 percent. It is open expert and free ware.

An education system in India has become so advance in previous decade due to the development of the technology class,video conferencing are some example of modern in education system. This system helps teachers to take attendance through a smart phone and keep record of student for their increasingappraisal.

II. LITERATURE SURVEY

Next conventional systems are utilized to be able to mark working the training method. Some sort of. Guide work process Is it doesn't conventional method connected with taking work by simply contacting names or even deciding upon in writing but it is dysfunctional owing to be able to more likelihood of not working and much more

document work likewise. Any individual can certainly bring other people cards to be able to mark proxy work [6]. C. Wireless Bluetooth Centered Attendance Method In this, work will be considered employing instructor's cellular phone. App software program is mounted in instructor's cellular phone, makes it possible for it to be able to dilemma student's cellular by using Wireless Bluetooth. It Geneva Chamonix transfers student's cellular Mass media Admittance Command (MAC) handles for the instructor's cell phone in addition to reputation from the student may be confirmed. The particular difficulty in this recommended process is student's phone is essential for work. In the case of apart student in case the cellular is fond of the good friend of course, if kept it in insurance region next also the reputation would be marked [9]. Every one of the preceding systems are time consuming in addition to hazardous. Within the actual recommended project Android mobile phone based work process is developed and that is fewer time consuming, safe and sound in addition to all too easy to put into action.

PROBLEM SOLUTION

A. PROPOSED SYSTEM

The purpose of Authentication module proven inside Number 3 is to supply stability. It's the gain access to module regarding application. Just about every user goes in his/her login as well as password in order to choose application.

B. University student attendance component

This specific component is actually specially intended for teachers. As soon as the address is finished, workers could post student attendance record inside data bank created about server. The entire attendance is calculated routinely in addition to message will be shipped to the particular mom and dad whoever keep has much less than 75% attendance.

C. Data bank element

The learning materials to be contributed are actually located on server. By ways of web it'll be broadcasted to everyone your documented learners.

D. TEXT MESSAGE notification element

Within TEXT MESSAGE notification element TEXT MESSAGE are going to be shipped to



Fig: Structure Diagram For Android System

Fig: Android Mobile system Architecture

Moms and dads or maybe learners. In the event parent notification solution is actually selected, next TEXT MESSAGE are going to be shipped to inserted cell phone nos. In the event university student notification solution is actually determined volume TEXT MESSAGE are going to be shipped to band of learners which goes compared to that category. With this particular element exam reminder, university student development, a smaller amount attendance intimation in addition to almost any critical observe could be directed. This kind of element they can be handy with regard to moms and dads in addition to learners. This smart link app in automating the previous guide technique. That is a paperless do the job. It may be supervised as well as manipulated remotely. It decreases the man strength necessary. It delivers exact information constantly. Malpractice could be lessened. Almost all a long time with each other obtained information could be stored which enable it to become used whenever you want. The results that is saved in the particular database helps in using smart choices by the operations. So it will be better undertake a World Wide Web as well as Operating system Centered University Operations technique. The many administrator, specialists, faculty, scholar as well as adults could possibly get the necessary information directly. This product is critical within the colleges.

Advantages:

School Attendance Management has come a long way from the days of recording and keeping attendance manually, and sending the information

to another member of staff for analysis and distribution. This could take days to complete. Even then, analysis results didn't include needed data for planning effective intervention for truancy problems.

While using proposed process revealed in Figure 1 educator can easily consider work of scholar along with personal portable and also distribute which document with internet server. Around the server part, percent work are going to be automatically worked out and also statement will probably end up being created keeping that in mind. In the TEXT notice element, TEXT are going to be provided for moms and dads or individuals. Within E-learning element information, time period tables will also be transmitted for the scholar.

2) OnClickListener: Click event for Button to jump or next Page. If user wants to jump one page to another then they can use the OnClickListener Event.

3) Input StreamReader: It is use for read the data.

4) equals (object obj): Compares this method against the specific object.

5) Declaring class: Methods declaring class. It is used to show the different methods for declaring class.

6) access flags: Using for bits encoding access.To encode the data using various bits encoding techniques.

7) doGet, doPost:doget and doPost method use to create a server in servlet.

DESIGN

The entire system consists of:

A. Authentication module:

The purpose of Authentication module is to provide security. Here while registering any new user, system asks for Enrolment ID so that the person belonging to that particular institute will only get registered and not any outsider.

While logging into the application each user enters his/her username and password to enter into application. If username and password is matched, application gets started. In our system Enrolment ID will work as username[3].

B. Student attendance module

This module is specially designed for faculty.After the lecture is done, staff canupload student attendance record in the database created on server. The overall attendance iscalculated automatically when the faculty enters criteria which is variable. Defaulter will bedisplayed after a specific period and an option of mailing it to faculty and also to the HOD isprovided in order to keep its softcopy stored.

There will be one more option of checking the attendance of particular period and the additional feature of filtering the result by entering cut off percentage for attendance is provided too.

C. Database module

III. Design & Methodology

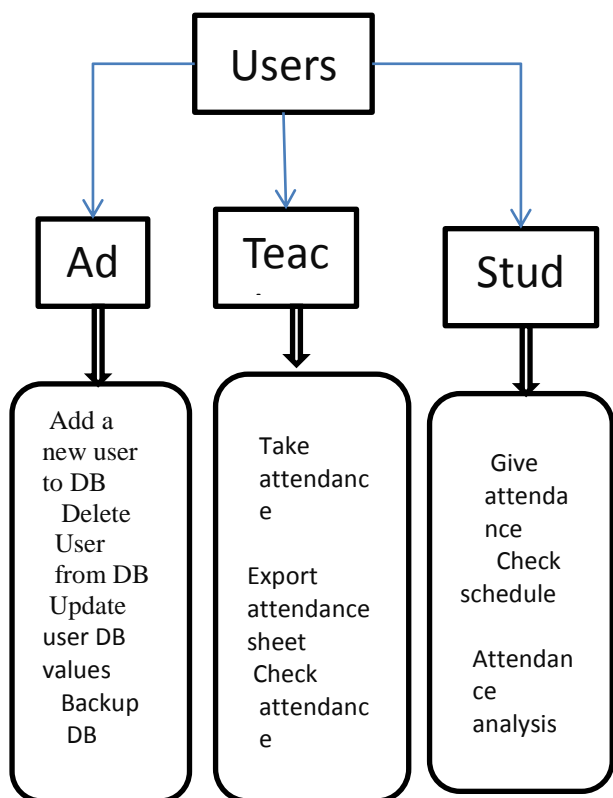

Fig: Adminstration System

1) Gson:Sending data to app to server. Gson file use to connectionbetween the android and server for download.

The admin only will be responsible for performing all the data related activities like create, delete, update and read. The non-academic notices will be uploaded by admin.

D. SMS notification module

In SMS notification module SMS will be sent to Parents or students. If parent notification option is chosen, then SMS will be sent to entered mobile nos. If student notification option is selected bulk SMS will be sent to group of students which belongs to that particular class. With this module examination reminder, student progress, less attendance intimation and any important notice can be sent.

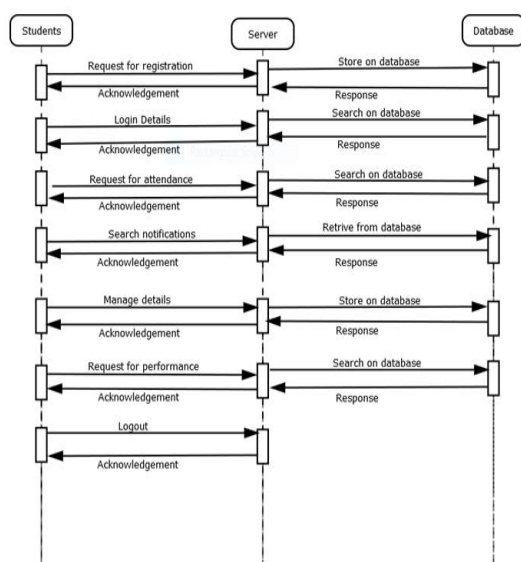

Fig: Sequence Diagram For Admin

IV. ADVANTAGES

1. Reduce paperwork and save time and money with mobile and cloud-based attendance management system. Eliminate duplicate data entry and errors in time and attendance entries.
2. Improve visibility to track and manage student attendance & absenteeism across multiple campuses.
3. Real-time status tracking of leave requests[5].

V. CONCLUSION

The Parent Portal and Attendance Monitoring System with SMS is a kind of system will inform the parent about the attendance of the student. The design and development of a system will record the attendance of the students in standalone system or the window-based system. The stand alone or window-based system is injected with the feature of Web Browser so that it will simultaneously save record in two different platforms, the Window-based and Web-based. The two platforms has separate database with identical data since the saving of records are being replicated by the use of the web browser in the stand-alone or window-based

system. The proposed system would help the parents in monitoring their child everyday or anytime and anywhere by receiving a notification that the student is absent. The parents can also access the Parent Portal anytime if they want to check the attendance and also the inputted grades of the student. Based from the finding of the study, researchers therefore conclude that the system functionalities are done in all the transaction and the system will be useful in the disseminating information, and will surely help the parents in monitoring their children anytime and anywhere without worries[4].

VI. REFERENCES

1. Merritt, Raymond H. (2008). "Technology." Microsoft® Student 2009 [DVD]. Redmond, WA: Microsoft Corporation.
2. Wilson, Lerrano B. (1999). "Grading System of Cabarroguis National School of Arts and Trade Gundaway Cabarroguis Quirino".
3. Jennifer, Cuthcon C. (2001). "Computerized Student Monitoring System". Unpublished thesis Information Technology, University of La Salle, Santiago City.

National Conference on Current Trends in Engineering, Science and Technology (NACCTEST-2018)

Organized by GF's Godavari College of Engineering, Jalgaon

International Journal of Innovations in Engineering and Science, Special Conference Issue, 2018

www.ijies.net

4. Storey, Philip A. (2008). "Hypertext Markup Language (HTML)." Microsoft® Student 2009 [DVD]. Redmond, WA: Microsoft Corporation.
5. Comer, Douglas E. (2008). "World Wide Web." Microsoft® Student 2009 [DVD]. Redmond, WA: Microsoft Corporation.

CSE-04 ACADEMIC TEACHING PLAN

Rupal More¹, Disha Jamdade², Varsha Chaudhari³, Suvarna Patil⁴, Prathmesh Joshi⁵

Student, Computer Engineering, Gf's gcoe, jalgaon1,2,3,4,5
rupalmore@gmail.com

¹ *Assistant Professor Dept. of Computer science , Godavari College of Engineering, Jalgaon, India*

² *Student, Dept. of Computer science , Godavari College of Engineering, Jalgaon, India.*

¹ *Student, Dept. of Computer science , Godavari College of Engineering, Jalgaon, India*

² *Student, Dept. of Computer science , Godavari College of Engineering, Jalgaon, India.*

³ *Student, Dept. of Computer science , Godavari College of Engineering, Jalgaon, India*

Abstract: A academic teaching plan is a teacher's detailed description of the course of instruction for a syllabus. A daily lesson plan is developed by a teacher to guide class learning. Details will vary depending on the preference of the teacher, subject being covered, and the needs of the students. There may be requirements mandated by the college system

regarding the plan. A academic teaching plan is the teacher's guide for running a particular lesson, and it includes the goal (what the students are supposed to learn). And it also include student attendance record and there marks details. Teacher also include there personnel information regarding there college record.

INTRODUCTION

In the current system all the activities are done manually. Academic teaching System deals with various activities related to students, teachers. It is very difficult and time consuming to retrieve the information of the individual student from the database. Academic teaching plan is a large database system which can be used for managing college's day to day activities. Academic teaching plan allows users to store almost all of their student's information electronically, including information of students, teachers etc. Most importantly, this information can be easily shared with authorized users, records can be easily searched, and reports can be easily generated. Academic teaching plan software is helpful for college authorities. Academic teaching plan provides following facilities- Students information All the necessary data about the student such as NAME,DOB, ADDRESS, TELEPHONENO etc. Teaching & Student info. To keep all the record of all the teaching and NAME, MOBLIE NO, ADDRESS, and SALARY, DATE OF JOINING.

LITERATURE SURVEY

Academic teaching plan incurs such application software designed for educational establishments to manage collage data. Academic teaching plan provide capabilities for entering student test and other assessment scores, building student schedules, tracking student

attendance as well as managing many other student-related data needs within the institution univer Thus, many of these systems applied in the Philippines can b scaled to different levels of activity and can be configured by their home institutions to meet local needs. M ver, before universities have created their own bespoke stude record system but with growing complexity in the business of educational establishments, organizations now choose to buy customizable within the shelf software. It can be that, modern Academic teaching plan are usually server-based, with the application residing on central computer server and are being accessed by client applications at various places within and even outside the school. During the year 1990s,

Academic teaching plan have been changing and are fast adopted through the presence of a web medium as a channel for accessing without any hassle upon viewing student details and information. Ideally, educational institutions are under constant pressure to demonstrate both willingness and capacity to incorporate the latest developments in Academic teaching plan along with communications technology supporting various teaching ways. As Liao et al., (2007) asserts that SIS process within such technological sophistication does create precise knowledge edge, that such SIS application can be appealing to students and to the academic faculty as well as the parents. Thus, believing that technology is the repository of the bulk of the information that underpins society's major enterprises and concerns and the

medium of communication through which SIS interact with one another. Furthermore, Project is transforming educational tactics understandings and school practices in relation to system information and to be able to assist better burgeoning of the Internet, the control exercised in the past by the Philippines from various departments of education and by individual teachers over pedagogical content may have diminished significantly. Through this new informative medium, resources of varying quality and provenance on

communication ground through execution, as found within the heart of learning mechanisms (Liao et al., 2007). as of today is changing what people is learning upon such as with the

virtually diverse subject matter are now available to the student

PROPOSED SYSTEM

In our proposed system we have the provision for adding the details of the students by teacher. Another advantage of the system is that it is very easy to edit the details of the student and delete a student when it found unnecessary. The results of the student are added in the database and so teachers can also view the result whenever they want. Another advantage of the system is that we can send the report of students to their parents through sms and notice to HOD and teachers through sms. The Alumina is added in the database and so it can be easily searched when it's necessary.

Our proposed system has several advantages

- User friendly interface
- Fast access to database
- Less error
- More Storage Capacity
- Search facility

All the manual difficulties in managing the student, staff details in a college have been rectified by implementing computerization.

INTERFACE DESIGN:

The interface design describes how the software communicates within itself, with systems that interoperate with it, and with humans who use it. An interface implies a flow of information (e.g., data and/or control) and a specific type of behaviour. Therefore, data and control flow diagrams provide much of the information required for interface design.

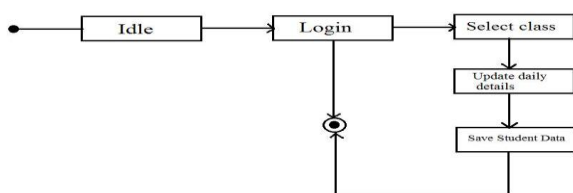

Fig4.1 Interface design of Result module.

As shown in the fig when the result of student is created then it will first check whether the student is Pass or Fail. If the Student is passing and she/he is in CLASS10 then it will collect the information from the All Student record and update it to the Alumina Table and then it will delete the record from the Class result is deleted. But if the Student is in other Class then their record is deleted from the previous semester and updated to the next semester.

FUNCTION ANALYSIS

The primary task of Academic teaching plan is to store & display the data of student, staff and much other information which are provided by the Administrator.

To accomplish these task three main functions is used:-

1. Save the data.
2. Search data.
3. Edit data.

1. Save :

This function is use to feed the information about Student, Staff etc in the data base. After entering the new information it is store the data in the data base. At the time of entering the data it also check that the data is entered is correctly or not if the data is not entered correctly then it generates error, else it store the data to data base.

2. Search:

This function is used to search any information from the data base. For searching information of Student the User had to just enter his Name, Class Roll no & then just click on this function. After this it will check the provided information with the data base and if the information is available then it will display the information about the Student or it will generate errors that please enter the data correctly. In the same manner all the information from the data base is searched.

3. Display :

This function is used for display the information of student, staff, result of student and alumina information

4. SMS:

This function is used for sending message to parents

sending message to the staff of the School.

BEHAVIOURAL ANALYSIS

Behavior Analysis is the scientific study of the principles of learning and behavior. This field of science is concerned with describing, understanding, predicting, and changing behavior. They seek answers by looking at involves basic research intended to add to the body of

knowledge about phenomena that control and influence behavior. Applied Behavior Analysis is

ARCHITECTURAL DESIGN:

Architectural design represents the structure of data and program components that are required to build a computer-based system. It considers the architectural style that the system will take, the structure and properties of the components that constitute the system, and the interrelationships that occur among all architectural components of a system. In the beginning the User will Enter the User name & Password after entering the User name and Password the system check the data with the data base after verifying if the entered data is Correct the a new window will open or else it will show error message. After verifying the data a new opened window contain many menus they are as follow:

1. Staff.
2. Time Table.
3. SMS.
4. Alumina.
5. Result.
6. Syllabus.
7. Student

After this the user will chose any one of this menu as per his choice.

1. Staff:

This menu contains two sub menus they are:

1. Teaching.

Both the menu contains same sub menus:

1. Add.
2. Search.
3. Edit.
4. Display.
5. Remove.

Add: If the User wants to add new Staff then he will select Add menu and a new form will form then the user will add all the required in the blank fields and then click on the save button. After clicking on the save button the information of the staff will be save to the data base.

Search: If the User wants to Search the information about any student then he/she will select the Search menu and a new window will open. This will contain the Name,

the biological and environmental factors, although they are primarily interested in the role of environment in behavior change. There are three main branches to the field: Conceptual Behavior Analysis, Experimental Behavior Analysis, and Applied Behavior Analysis. The Conceptual branch focus es on the philosophical, theoretical, historical, and methodological issues that underlie the field. Experimental Behavior Analysis

focused on the application of the principles of behavior to the needs of individuals to promote behavior change and improve quality of life.

PRN no. the User will enter the data in this field and then click on search button and if the information about the student is available in the data base then it'll show the information about the student.

Edit Student: If the User wants to edit the information about the student then he/she will select Edit menu and a new window will open then User will enter the name, PRN no. of the student and the information will be displayed on the screen and then User can Change/Modify the information and save to the data base.

Display: In this field all the Student information will be display.

2. Student: This menu contains four sub menus they are:

- Add Student.
- Search Student.
- Edit Student.
- Display Student

Add Student: If the User wants to add new Student then he will select Add student menu and a new form will form then the user will add all the required in the blank fields and then click on the save button. After clicking on the save button the information of the student will be save to the data base.

Search Student: If the User wants to Search the information about any student then he/she will select the Search menu and a new window will open. This will contain the Gr. No, Name & Roll Number the User will enter the data in this field and then click on search button and if the information about the student is available in the data base then it'll show the information about the Student.

Edit Student: If the User wants to Edit the information about the Student then he/she will select Edit menu and a new window will open then User will enter the name, Roll no, Class, Gr no of the students and the information will be displayed on the screen and then User can Change/Modify the information and save to the data base.

Display Student: It Contains Two sub menus:0

1. Display All: In this field all the Students Information will be display from the School.
2. Display Student: In this field Student information according to class wise will be displayed.

Remove Student:

In this Field If the user wants to remove any student from the data base then he/she will select this menu. A

new window will open and will Ask for Gr. No, Name, Roll no, Class of the student and then after clicking on the remove button the data of particular student will be removed.

3. SMS :The User can send the SMS to Parents, Teachers and Staff from this menu.

It contains the Mobile no to which the Message is to send and the Text field

2. Search.

Add:

In this the User will enter the information about students those who have cleared their X exams and then click on save button to save the information.

Search:

In this if the User wants to the information about any student those who had cleared their X then he/she will select this menu

4. Result:

This menu contains the three sub menus:

1. Add.

2. Search.

Add:

In this field the User will generate the Result of student Class wise.

Search:

In this field the User can search the Result of any student from the class.

that is embedded in HTML. It is used to manage dynamic content, databases, session tracking, even build entire e-commerce sites.

It is integrated with a number of popular databases, including MySQL, PostgreSQL, Oracle, Sybase, Informix, and Microsoft SQL Server. PHP is pleasingly zippy in its execution, especially when compiled as an Apache module on the Unix side. The MySQL server, once started, executes even very complex queries with huge result sets in record-setting time. PHP supports a large number of major protocols such as POP3, IMAP, and LDAP. PHP4 added support for Java and distributed object architectures (COM and CORBA), making n-tier development a possibility for the first time. PHP is forgiving: PHP language tries to be as forgiving as possible.

HTML

HTML is a hypertext markup language which is in reality a backbone of any website. Every website can't be structured without the knowledge of html. If we make our web page only with the help of html, than we can't add many of the useful features in a web page, for making a web page more effective we use various platforms such as CSS. So here we are using this language to make our web pages more successful as well as efficient. And to make our web pages dynamic we are using Java script

OBJECTIVE:

To make the application of Student Information management System usable for the College or Universities.

To access the student's records and get the desired information which may require.

To automate the existing system of manually maintain the records of the student records, Students Details, Attendance Details, Internal Marks etc.

To increase data accuracy, make student information management more secure, effective, convenient and accessible.

Providing the online interface for students, faculty etc.

Increasing the efficiency of college recordmanagement.

Decrease time required to access and deliver student records.

MySQL

MySQL is a relational database management system that runs as a server providing multi-user access to a number of databases. MySQL is a popular choice of database for use in web applications and is an open source invention.

MySQL Features

1. MySQL are very fast and much reliable for any type of application.
2. MySQL is very Lightweight application.
3. MySQL command line tool is very powerful and can be used to run SQL queries against database.
4. MySQL supports indexing and binary objects.
5. It is allow changes to structure of table while server is running.
6. MySQL has a wide user base.
7. It is a very fast thread-based memory allocation system.

TECHNICAL OVERVIEW:

PHP

PHP is a recursive acronym for "PHP: Hypertext Preprocessor". PHP is a server side scripting language

ADVANTAGES :

The Academic teaching plan is an electronic version of manual College Management System. It can handle all details about a college. The details include syllabus details, student personnel details, teachers details, exam result detail etc...

In case of manual system they need a lot of time etc. Here almost all work is computerized. So the accuracy is maintained. Maintaining backup is very easy. It can do with in a few minutes. Our system has three type of accessing modes, teaching staff, HOD, and Principal. Academic teaching plan is managed by teacher. It is the job of the teacher to insert update and monitor the whole process. When a staff-login to the system. He would only view and update details of the student, syllabus & student attendance. The system has eight modules. They are

- Teaching & Student info.
- SMS.
- Result.
- Class Database

CONCLUSION :

This website help us develop and maintain the database of Teaching Record. It helps us to maintain the record of student such as student database like name, address, roll no, results, marks etc. It helps us to maintain the record of the staff such as name, address date of joining, salary, assigned subject etc.

We design tools for Student information

management system, and the development, implementation, and database management system for online college. We show alternative design techniques and components. We also focus to make a good relationship between teacher and student to make as in the education system, The system provides an effective environment contribute to the follow up basis of the performance of the students during the year and helps create an environment in constant communication among students, parents, teachers and college administration / university. The waste of computer resources, workers, and time associated with the existing manual system. This project will provide the student's information management system serves as a useful approach Database dialog box for the update function, advanced search options to the authorized person and continuing link between each student and

discuss any questions and exchanged the ideas of students, it serves as a useful approach for users. It reduces the time it takes a user to add, update, delete, view and search for information.

ACKNOWLEDGMENT :

We would like to acknowledge all the people who have been of the help and assisted me throughout my project work.

First of all we would like to thank my respected guide Prof. Nilesh Vani in Department of Computer Engineering for introducing me throughout features needed. The time-to-time guidance, encouragement, and valuable suggestions received from him are unforgettable in our life. This work would not have been possible without the enthusiastic response, insight, and new ideas from him.

We gladly take this opportunity to thank Principal in GF' s Godavari College of Engineering, Jalgaon and the H.O.D of Computer department Prof. Pramod Gosavi and The project-I In-charge Miss. Rupal Patil for providing all the facilities during the progress of project.

We would like to thank my lovely parents for time-to-time support and encouragement and valuable suggestions, for the emotional as well as strong support each and every time also for continued loving care and emotional support at every stage of this project.

The acknowledgement would be incomplete without mention of the blessing of the Almighty, which helped me in keeping high moral during most difficult period

REFERENCES :

1. Pressman, "Software Engineering", McGraw Hill, 5th Ed.
2. Henry F. Korth, Abraham silberschatz, "Database system concepts", 5th Ed. Mc Graw Hill Inc.
3. https://en.wikipedia.org/wiki/Applied_behavior_analysis
4. <http://codex.cs.yale.edu/avi/db-book>
5. https://en.wikipedia.org/wiki/Database_System_Concept

CSE-05 STUDENT INFORMATION MANAGEMENT SYSTEM

N.S.Vani¹, P.R.Patil², A.D.Vadnere³, A.S.Patil⁴, R.M.Shaikh⁵, L.B.Ghate⁶

*Assistant Professor, Computer Engineering Department,
nileshvani@gmail.com*

GF' s Godavari College of Engineering, Jalgaon , India, 425001

Student of Computer Engineering Department,

GF' s Godavari College of Engineering, Jalgaon , India, 425001

Student of IT Engineering Department,

GF' s Godavari College of Engineering, Jalgaon, India, 425001

Abstract: -Student Information Management System provides a simple interface for sequence of database of student information. We made system information management system for educational institutes or colleges to maintain the details of students easily. The creation and management makes accurate, up-to-date information according to a student's academic profession is main in the university as well as colleges. Student information system deals with all kind of student details, academic related information, college details, course details, curriculum, batch details, placement details and other source related details too. The student information management system tracks all the details of a student from the starting date to the end of the semester or course which is used for all reporting purpose, tracking of attendance, progress in the course, to completed semesters, years, coming semester year curriculum details, project or any other assignment details, exam result and all these information will be available through a safe way. It will also have faculty details, batch execution details, students' details in all aspects, the various academic notifications to the staff and students updated by the college administration. It also facilitate us explore all the activities occurrence in the college, Based on huge options related to student batch, course, faculty, exams, semesters, certification and even for the entire college different reports and queries will be generated.

Keywords: -Student Information System, Database, HTML, SQL, Apache, DFD.

INTRODUCTION

The design and implementation of a complete student information system and user interface is to replace the current paper work .College Staff are able to

directly access all information of a student's academic growth through a secure, online interface embedded in the website. The system use user permission, displaying only information necessary for an individual's. Furthermore, each sub-system has verification allowing authorized users to create or update information in that system. All data is thoroughly reviewed and validated on the server before actual record change occurs. In addition to a staff user interface, the system plans for student user interface, allowing users to access information and submit requests online thus reducing process time. All data is stored securely on servers and ensures maximum possible level of security. The system features a difficult logging system to track all users access and ensure conventionality to data access rule and is expected to increase the correctness of the student record management thereby reduced the work time needed to fetch and transport student information to users[2].

Previously, the college relied closely on paper records for this idea. While paper records are a fixed way of managing student data there are several drawbacks into this. First, to transmit information to the students it should be displayed on the notice board and the student has to visit the notice board to check that information. It takes a very long time to communicate the information to the student. Paper records are difficult to manage and store[3]. The physical effort or work required to retrieve, change, and re-file the paper records are all non-value added activities. This system provides a simple interface for the maintenance of student data. It can be used by educational institutes or colleges to maintain the records of students easily. Achieving this objective is difficult using a manual system as the information is spotted, can be redundant and collecting relevant information may be very time consuming. All

these problems are solved using student information management system. The paper focuses on used information in an easy and understandable manner which provides function like online registration and profile creation of students thus reduce the paper work and automate the record build process in an educational institution or colleges.

METHODOLOGY

User authentication is one of the most important factors in the proposed system. Every student is authenticated based on his/her single user identification number. This single identification number is the number which is given by the system. The identification number along with other information is also saved in the database.

At first Student has to login on system. When the Student login the system, then Student is automatically connected to the college internet and can perform any operation on database. After performing required operation student log out from system and come back to home page.

DATA DESIGN

HOD:

- Logins
- Manage teachers
- ADD, Update, Delete, view
- Manage Students
- ADD, Update, Delete, view
- Manage notification

Teachers:

- Registration
- Login
- Manage Details
- Add, Update, delete
- Manage students
- ADD, Delete, Update, approved, reject

Students:

- Registration
- Login
- Manage Details
- Add, Update, delete
- view notification
- View Details

DESIGN

A)DFD

A Data Flow Diagram (DFD) is a graphical demonstration of the “flow” of Student Information System. A data flow diagram can also be used for the image of Data Processing. DFD shows the contact between the system and outside entities. This context-level DFD is then “exploded” to show more detail of the system being model. A DFD represents flow of data through a system. Data flow diagrams are commonly used during problem analysis. It views a system as function that transforms the given input into required output. Movement of data through the different transformations or processes in the system are shown in Data Flow Diagram.

DFD 0

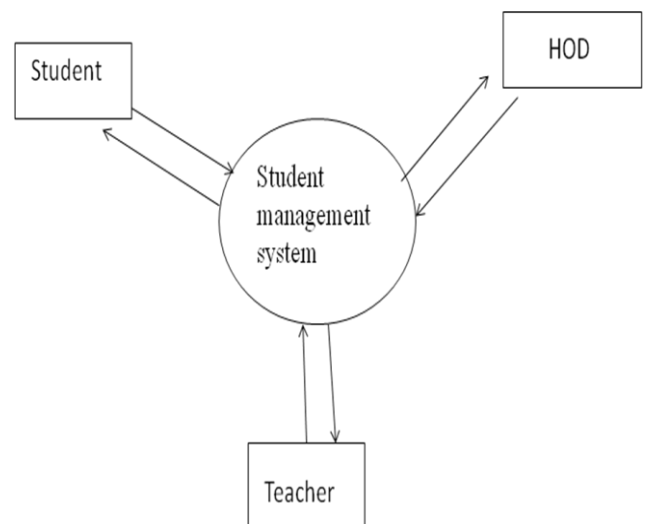
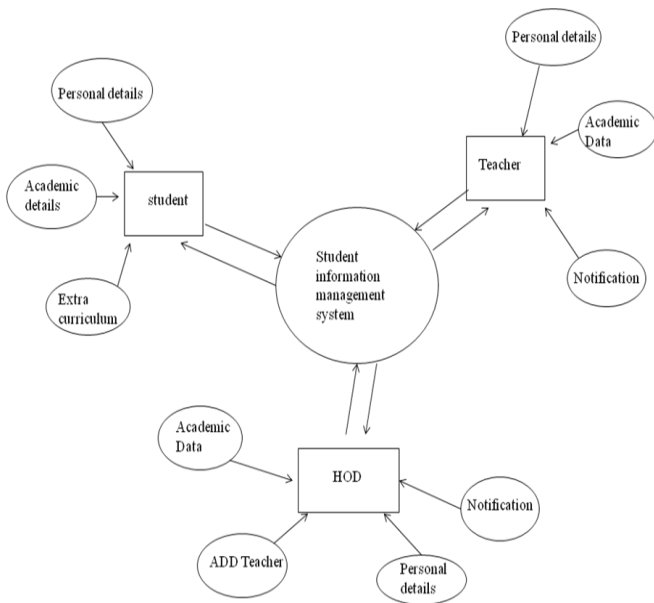

Fig.1 DFD 0

Detail DFD Flow

DFD 1



Fig,2DFD 1

a) Student

Students are register by HOD only to the system. When he got register the user name and passwords are generated by admin and can be managed by student afterwards. Student has access to personal profile, Class Tests records, Daily Class Routines and all the notifications and upcoming events which are managed by HOD. One more important facility provided for students is to view the notification of his/her individual.

Purpose of project is to maintain details of the students such as storing Information about:

- Student id
- Student password
- Student name
- Student DOB
- Student mailing address,Gender
- Registration date
- Student status
- Contact no
- Qualification
- City
- Resume

b) Faculty

Staff has access rights to manage all the data of their subjects of respective class. Staff members are able to give notifications and can upload some documents related to their particular subjects. Staff can generate the daily, monthly or yearly report of individual student as

well as class. Time table generation facility is also available for staff. Instead of manual work this application gives automatic work department.

Following right of faculty

- a) Lectures will get their respective time tables from the general time table uploaded by the HOD.
- b) Will see their allotted subjects and the respective classes' semester wise and can view the details (lesson plan, syllabus, list of experiments and assignments) of subjects.
- c) They can modify their own profile and view general details of others profiles.
- d) Can view Feedback for their subjects only.
- e) Can see result analysis for their subjects only.

c) HOD

HOD can manage the accounts of the all the students and staff. All the logs of student information can be view and manage by HOD itself. HOD can also upload notices regarding admission forms etc. HOD can view all the students and approve.

B) REQUIRMENT ANALYSIS

This involves obtaining a clear idea about the project with the view to remove all ambiguities and irregularity from the initial customer perception of the problem. After the analysis has collected the requirements regarding the system to be developed and has removed all the inconsistencies and anomalies from the specification each start to systematically organize the requirement in document.

a) Major requirement

- Student personal details information.
- Student Academic details information.
- Teacher personal details information.
- Teacher educational material information.
- HOD information details.
- Notifications.
- Having internet connection.

b) Minorrequirement

- Minimum credit point achievement
- Teacher Schedule
- Student Schedule

c) Software Requirement

- Operating system: Windows
- Front end : HTML
- Back end: java script , MySQL /Apache Server

d) Hardware Requirement

- Processor (i3)
- Hard Disk(min 10GB)
- RAM (min 1GB)
- Power

OBJECTIVE

- To make the application of StudentInformation managementSystemusable for the College or Universities.
- To access the student's records and get the desired information which may require.
- To automate the existing system of manually maintain the records of the student records,
- Students Details, Internal Marks etc.
- To increase data accuracy, make student information management more secure, effective, convenient and accessible.
- Providing the online interface for students, faculty etc.
- Increasing the efficiency of college record management.
- Decrease time required to access and deliver student records.
- Provide notes to student on one click.

TECHNICAL OVERVIEW

JAVA SCRIPT

We used the browser i.emozila. JavaScript is considered to be one of the most powerful scripting languages in usetoday world. It is often used for the web development. JavaScript is used to make web pages more interactive and dynamic[1]. JavaScript is a light weight programming language and it is set in directly into the HTML code.

JavaScript is measured to be one of the most popular scripting languages of all the time. JavaScript by the definition, it is a Scripting Language of the World Wide Web. The main usage of JavaScript is to add various Web functionalities, Web form validations, browser detections, creation of cookies and so on. JavaScript is one of the most popular scripting languages

and that is why it is supported by almost all web browsers available today like opera[6].

HTML

HTML is a hypertext markup language which is in reality a backbone of any website. Every website can't be structured without the knowledge of html. If we make our web page only with the help of html, than we can't add many of the useful features in a web page, for making a web page more effective we use various platforms such as CSS. So here we are using this language to make our web pages more successful as well as efficient. And to make our web pages dynamic we are using Java script[1].

MySQL

MySQL is a relational database management system that runs as a server providing multi-user access to a number of databases. MySQL is a popular choice of database for use in web applications and is an open source invention.

MySQL Features

1. MySQL are very fast and much reliable for any type of application.
2. MySQL is very Lightweight application.
3. MySQL command line tool is very powerful and can be used to run SQL queries against database.
4. MySQL supports indexing and binary objects.
5. It is allow changes to structure of table while server is running.
6. MySQL has a wide user base.
7. It is a very fast thread-based memory allocation system.
8. MySQL Written in C and C++ language.
9. MySQL code is tested with different compilers.
10. MySQL is available as a separate program for use in a client/server network environment.
11. The MySQL available for the most UNIX operating platform.
12. MySQL are the available for window operating system window NT, window 95 ,and window 98.
13. MySQL available for OS/2.

14. Programming libraries for C, Python, PHP, Java, Delphi etc. are available to connect to MySQL database.

APACHE TOMCAT SERVER

Apache Tomcat is an open source Web server tool developed by the Apache Software Foundation (ASF). It is one of many Apache-related open source products used by IT professionals for different tasks and objectives. Apache Tomcat allows the execution of Java Servlets and JavaServer Pages (JSP) to promote an effective Java server background. Users can also access resources for design and use extensible markup language (XML) to organize projects. Successive versions of Apache Tomcat have solved different problems by applying software patches and other solutions. Some experts differentiate Apache Tomcat as a product offering a runtime shell for Java Servlets. Users can also set up Java virtual machines (JVM) to arrange virtual hosting.

CONCLUSION

This is a paperless work. It can be monitored and controlled remotely. It reduces the man power required. It provides correct information always. Mismanagement can be reduced. All years together gathered information can be saved and can be accessed at any time. The data which is stored in the store helps in taking quick decisions by the management. So it is better to have a student Information Management system. All the user, faculty and management can get the required information without wait. This system is essential in the colleges/hostels and universities.

we design tools for Student information management system, and the development, implementation, and database management system for online college. We show alternative design techniques and components. We also focus to make a good relationship between teacher and student to make as in the education system, The system provides an effective environment contribute to the follow up basis of the performance of the students during the year and helps create an environment in constant communication among students, parents, teachers and college administration / university. The waste of computer resources, workers, and time associated with the existing manual system. This project will provide the student's information management system serves as a useful approach Database dialog box for the update function,

advanced search options to the authorized person and continuing link between each student and discuss any questions and exchanged the ideas of students, it serves as a useful approach for users. It reduces the time it takes a user to add, update, delete, view and search for information.

ACKNOWLEDGMENT

We would like to acknowledge all the people who have been of the help and assisted me throughout my project work.

First of all we would like to thank my respected guide Prof. NileshVani in Department of Computer Engineering for introducing me throughout features needed. The time-to-time guidance, encouragement, and valuable suggestions received from him are unforgettable in our life. This work would not have been possible without the enthusiastic response, insight, and new ideas from him.

We gladly take this opportunity to thank Principal in GF' s Godavari College of Engineering, Jalgaon and the H.O.D of Computer department Prof. PramodGosavi and The project-I In-charge Miss. RupalPatil for providing all the facilities during the progress of project.

We would like to thank my lovely parents for time-to-time support and encouragement and valuable suggestions, for the emotional as well as strong support each and every time also for continued loving care and emotional support at every stage of this project.

The acknowledgement would be incomplete without mention of the blessing of the Almighty, which helped me in keeping high moral during most difficult period.

REFERENCES

- [1] *International Journal of Advanced Research in Computer and Communication Engineering* Vol. 2, Issue 6, June 2013.
- [2] *Volume 5, Issue 2, February (2014), pp. 09-18 © IAEME: www.iaeme.com/ijcet.asp Journal Impact Factor (2014): 4.4012 (Calculated by GISI) www.jifactor.com*
- [3] *International Conference on Economic Management and Trade Cooperation (EMTC 2014) © 2014. The authors - Published by Atlantis Press*

[4]Sauer, C (1993) “ *Why Information Systems Fail: A Case Study Approach*” Alfred Waller Ltd, Henley-on-Thames, Oxfordshire.

[5]Avison D.E & Shah H.U. (1997) “ *The information systems development life cycle: a first course in information systems*” , McGraw-Hill.

[6]Stapleton J. (1997). “ *DSDM, Dynamic Systems Development Method*” . Addison- Wesley.

[7]International Journal on Recent and Innovation Trends in Computing and Communication ISSN: 2321-8169 Volume: 3 Issue: 2

CSE-06 ACTIVE ZIGBEE AND GPS BASED PRECISE DEVICE TRACKING SYSTEM

Mr. Prasad Rajendra Joshi (MTech)

Branch :Computer Sci & engg
Godavari college of engineering, Jalgaon
Email: prasadjoshi469@gmail.com
Mobile.no: +917350346623

Abstract—GPS is one of the technologies that are used in a huge number of applications today. One of the applications is tracking various Portable Devices and keeps regular monitoring on them. This tracking system can inform you the location of Equipment which is embedded this hardware, and that information can be observed from any other remote location. This system enables us to track target in any weather conditions. This system uses GPS and Zigbee technologies. A method for tracking Device using a terrestrial system similar to GPS is presented. With GPS and public Google Map API functionalities, global location and sensor information are sent over networks to an cell-phone embedded with a simplified Zigbee technology used to track device, in addition combination of these technologies resulting feasible and efficient tracking of various devices.

To develop a prototype project that can help to assist user in detect a missing Device. To create a pair of device used Zigbee and GPS technology that can detect each of devices which is will emit a Message and latitude & longitude coordinates when it reach the distance limit. To help user to guide to find stolen device from any location and aware from any lost occur in limitation distance.

Virtually anything on the world can be mapped, and anyone can create a map, given the knowledge of the location of attractions relative to the latitude and longitude boundaries. This can be useful not only for vehicles lost or stolen on any place, but for cars, bicycles and key-chains etc. This product may have a high potential market for many people with their many loved devices want to ensure the safety of their devices.

Keywords— Transmitter,Receiver,Tracking device ,GPS, Zigbee,GSM

I. INTRODUCTION

GPS is one of the technologies that are used in a huge number of applications today. One of the applications is tracking Mobile or Any Portable Device and keeps regular monitoring on them. This tracking system can inform you the location and route travelled by Equipment which is embedded this hardware, and that information can be observed from any other remote location. This system enables us to track target in any weather conditions. This system uses GPS and Zigbee technologies. A method for tracking Device using a terrestrial system similar to GPS is presented. This system enables simultaneous tracking of thousands of Equipment's with transmitters that are lighter, longer lasting, more accurate and cheaper than other automatic positioning tags. An open architecture for Device tracking systems using various sensors built into a compact prototype, easily embedded in any Device.

With GPS and public Google Map API functionalities, global location and sensor information are sent over networks to an Cell phone, embedded with a simplified Zigbee technology used to track device when closing by with an adaptive alert Message to the receiver for monitoring and searching. In addition, to efficiently save the battery power and cost of the tracking system, and then implemented resulting in feasibility and efficiency of battery power and data transmission.

Now a day's technology is growing higher and higher pick level, because of this the common people are ready to absorb these technology facilities in their daily life. In their day to day life peoples are demanding to protect their instruments, devices etc. by using the available resources. Hence this project is made on the platform of this demand. Problem statements:

- People's difficult to monitor their devices when they are busy or at public area.
- The disappearance of the device at the public's attention often occurs.
- Difficulties in finding the device which stolen from them.

Fig 1: Arduino UNO R3

Components Required:

- Arduino
- GSM-GPS Module
- 16x2 LCD
- Power Supply
- Connecting Wires
- Zigbee
- SIM Card

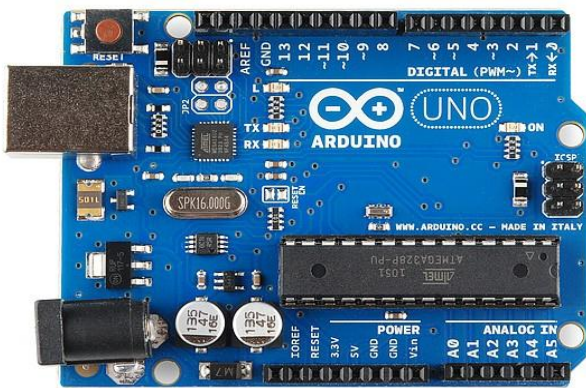

The Uno differs from all preceding boards in that it does not use the FTDI USB - to-serial driver chip. Instead, it features the Atmega16U2 (Atmega8U2 up to version R2) programmed as a USB-to-serial converter.

Revision 2 of the Uno board has a resistor pulling the 8U2 HWB line to ground, making it easier to put into DFU mode.

Revision 3 of the board has the following new features:

- 1.0 pinout: added SDA and SCL pins that are near to the AREF pin and two other new pins placed near to the RESET pin, the IOREF that allow the shields to adapt to the voltage provided from the board. In future, shields will be compatible with both the board that uses the AVR, which operates with 5V and with the Arduino Due that operates with 3.3V. The second one is a not connected pin that is reserved for future purposes.

- Stronger RESET circuit.
- ATmega 16U2 replace the 8U2.

"Uno" means one in Italian and is named to mark the upcoming release of Arduino 1.0. The Uno and version 1.0 will be the reference versions of Arduino, moving forward. The Uno is the latest in a series of USB Arduino boards, and the reference model for the Arduino platform.

B. GPS-GSM Module(SIM 808)

GPS-GSM Module (SIM808) module is a complete Quad-Band GSM/GPRS module which combines GPS technology for satellite navigation.

This compact design which integrated GPRS and GPS in a SMT package will significantly save both time and costs for customers to develop GPS enabled applications. Featuring an industry-standard interface and GPS function, it allows variable assets to be tracked seamlessly at any location and anytime with signal coverage.



Fig2: GPS-GSM (SIM808) Module

C. LCD 16x2

LCD (Liquid Crystal Display) screen is an electronic display module and find a wide range of applications. A 16x2 LCD display is very basic module and is very commonly used in various devices and circuits. These modules are preferred over seven segments and other multi segment LEDs. The reasons being: LCDs are economical; easily programmable; have no limitation of displaying special & even custom characters (unlike in seven segments), animations and so on.



Fig 3: LCD 16x2

The receiver module is activated when its within the range of transmitter module. Which is decoded and send message to the LCD screen (Pin D4 to D7) to display the confirmation message (Module is Found). If the receiver is in the range of transmitter module then Zigbee module activated and sends the confirmation signal to Arduino (Pin 2 DATA to D12).

D. Power Supply

Power supply device for the conversion of available power of one set of characteristics to meet specified requirements Typical application of power supplies includes converting raw input power to a controlled or stabilized voltage and/or current for the operation of electronic equipment.



Fig 4: Power Supply Adapter

E. Zigbee

ZigBee is a wireless networking standard that is aimed at remote control and sensor applications which is suitable for operation in harsh radio environments and in isolated locations.

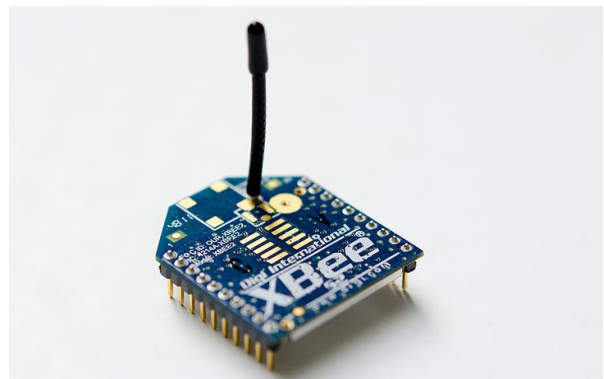

Fig 5: Zigbee Module

ZigBee is a low rate, low cost, low power wireless communication standard, which aims to be used in home automation and remote control applications. ZigBee standard has been designed to offer minimum cost and power connectivity for devices which require battery life for durations ranging from several months to several years. ZigBee devices are expected to cover 10–75 meters based on the RF environment and output consumption required for a given application. Each ZigBee network involves three main components as shown in Figure 2: coordinator (ZC), routers (ZR) and

end-devices (ZED). Only one coordinator is require for each ZigBee network, and it initiates the network formation. A router is an optional network component. It may associate with coordinator, and participates in the multi-hop routing of messages. And finally, an end-device which is optimized for low power-operation and only connects to one coordinator or router.

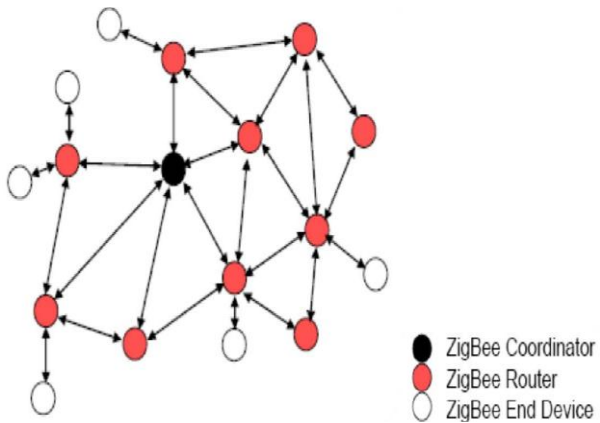

Fig 6: ZigBee mesh network
 (see online version for colours)

Zigbee is to guide and confirm the Detected location when the receiver module is in the range of Zigbee transmitter. The GSM send the coded co-ordinates to Cell phone and returns a signal to Arduino (Pin D0) for the conformation of operation completed. At the same time the Arduino activate the Zigbee transmitter module (Pin D12) till the operation completed and provides the 5 V supply

The receiver module is activated when its within the range of transmitter module. Which is decoded and send message to the LCD screen (Pin D4 to D7) to display the confirmation message (Module is Found). If the receiver is in the range of transmitter module then Zigbee module activated and sends the confirmation signal to Arduino (Pin 2 DATA to D12). We can track the stolen dead mobile or any device by following detected co-ordinates (Latitude and longitude) and confirm the location by detecting the respective Zigbee signal received from the stolen device.

- **ZigBee Wireless Network:** This is the section which physically doesn't exist. It consists of the wireless communication between the ZigBee modules attached to the Transmitter and Receiver Arduino board and microcontroller board.

II. FLOW DIAGRAM

A. Operational Flow Diagram Of Transmitter Module

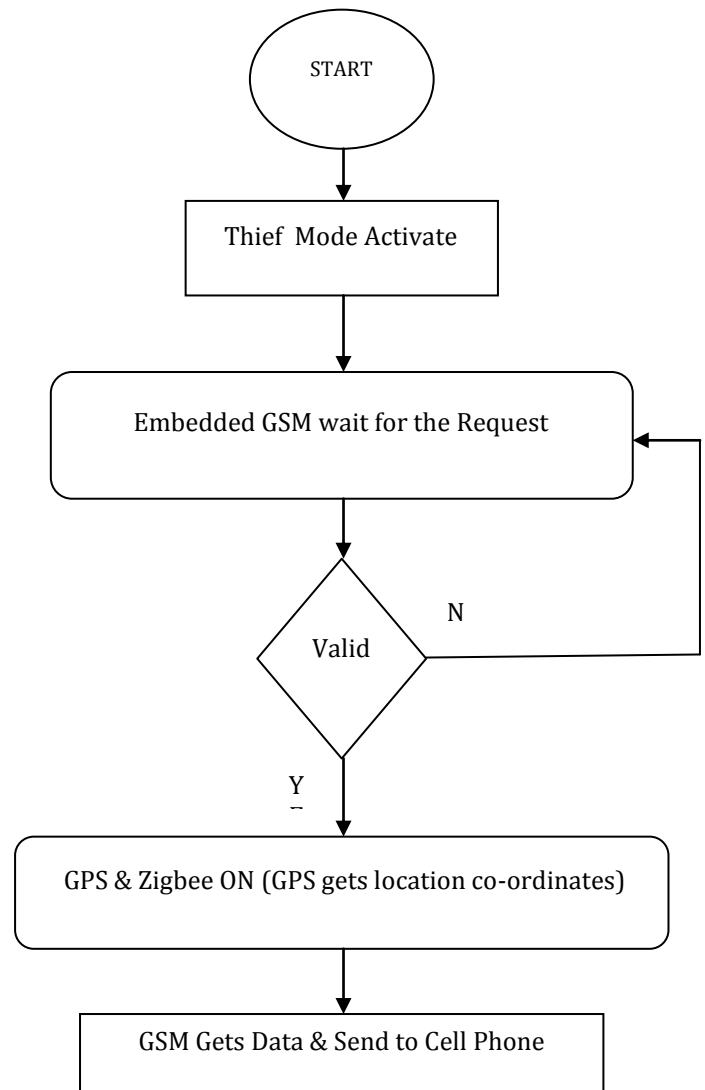
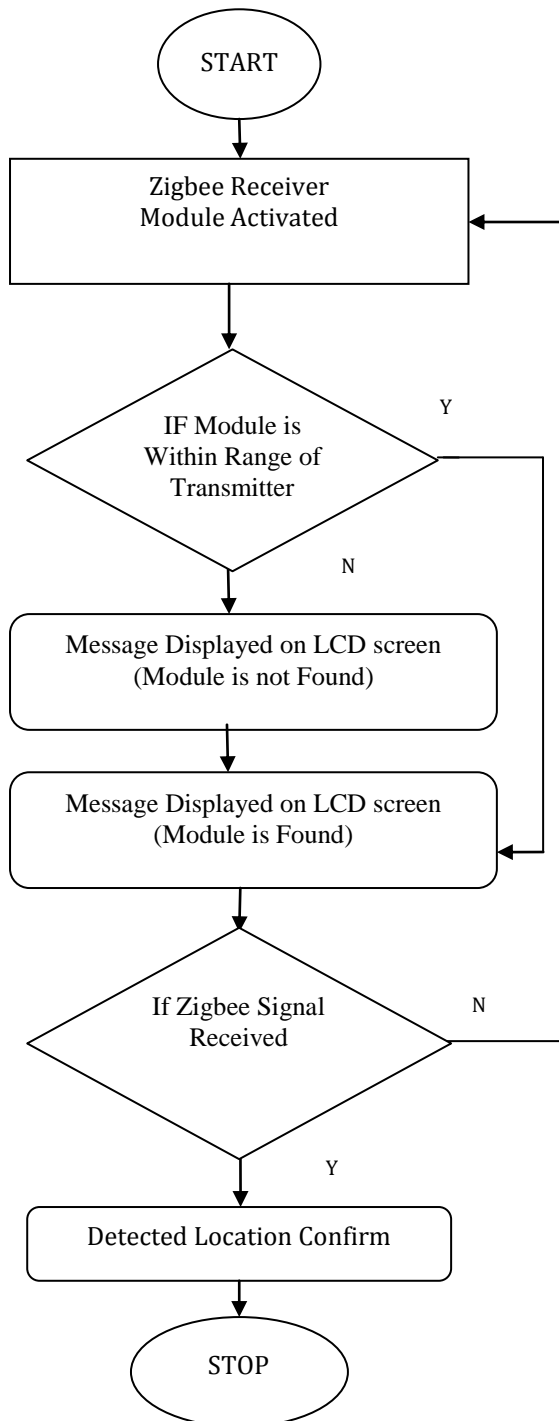

Fig.7: Operational Flow Diagram Of Transmitter Module

B. Operational Flow Diagram Of Receiver

Fig 8:Operational Flow Diagram Of Receiver



• **Description**

To know the working of this system we describe the system in two parts as per its module.

1) *Transmitter Module*

This transmitter prototype designed to get active and send the location co-ordinates to the registered mobile number on cell phone when device is stolen. As per the circuit diagram we use the Arduino as control unit, GPS for to the detect location co-ordinates, GSM (Any strong future technology is used instead of GSM is used to send the detected co-ordinates to the cell phone. It can be replaced) is used to send the detected co-ordinates, and Zigbee is to guide and confirm the Detected location when the receiver module is in the range of Zigbee transmitter.

When your Device is stolen by thief then the thief's will not know ,we track them. After that now in current devise we have no tech to detect or track our stolen mobile or any device. The transmitter prototype having the switch to replicate the situation as per above mention. When this switch is pressed or got the power the transmitter is active and detects the current location and send to the cell phone

Now in this prototype when transmitter module is active then the GPS module is get the co-ordinates and send to the control unit (Arduino Uno R3) to the pin D10. The Arduino decodes the data and send to the GSM module (Pin D1). The GSM send the coded co-ordinates to Cell phone and returns a signal to Arduino (Pin D0) for the conformation of operation completed. At the same time the Arduino activate the Zigbee transmitter module (Pin D12) till the operation completed and provides the 5 V supply.

2) *Receiver Module*

The receiver module is activated when its within the range of transmitter module. Which is decoded and send message to the LCD screen (Pin D4 to D7) to display the confirmation message (Module is Found). If the receiver is in the range of transmitter module then Zigbee module activated and sends the confirmation signal to Arduino (Pin 2 DATA to D12). We can track the stolen dead mobile or any device by following detected co-ordinates (Latitude and longitude) and confirm the

location by detecting the respective Zigbee signal received from the stolen device.

As per our requirement we can use this technology in many devices.

III. CIRCUIT DIAGRAM

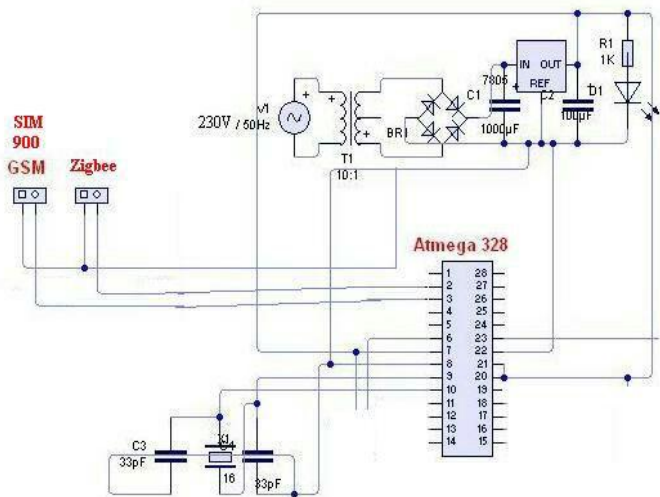

Fig 9: Transmitter Module

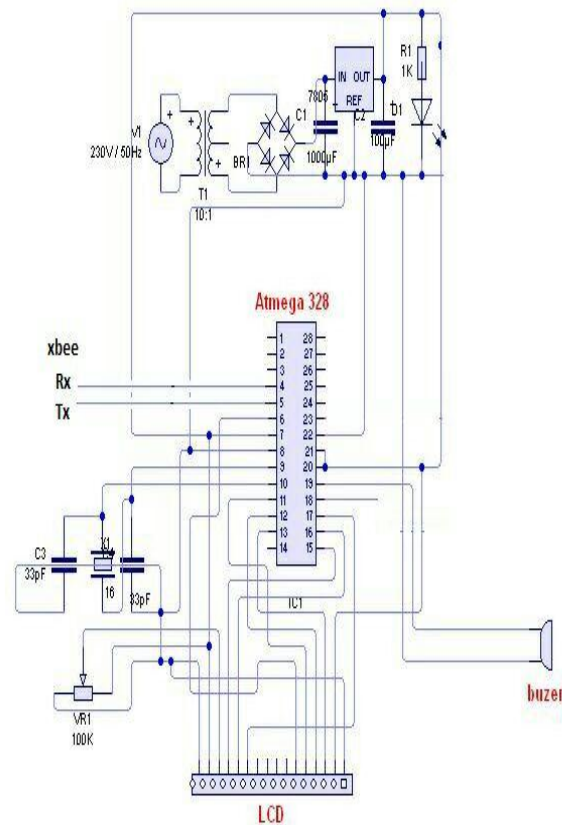

Fig 10: Receiver Module

IV. LITERATURE SURVEY

1. Real-time tracking and management of Device has been a field of interest for many researchers and a lot of research work has been done for tracking system. Recently the various anti-theft modules like steering wheel locked equipment, network tracking system and traditional electronic alarm are developed along with client identification and real time performance monitoring.
2. The paper presented by El-Medany, W.; Al-Omary et al describes a real time tracking system that provides accurate localizations of the tracked vehicle with low cost. GM862 cellular quad band module is used for implementation. A monitoring server and a graphical user interface on a website is also developed using Microsoft SQL Server 2003 and ASP.net to view the proper location of a Device

on a specific map. The paper also provides information regarding the vehicle status such as speed, mileage.

3. Hu Jian-ming; Li Jie; Li Guang-Hui describes an automobile anti-theft system using GSM and GPS module. The system is developed using high speed mixed type single-chip C8051F120 and stolen Devices is detected by the use of RF technology.

The system remains in contact with Device owner through the GSM module, for the safety and reliability of Device. Fleischer, P.B.; Nelson et al describes development and deployment of GPS (Global Positioning System)/GSM (Global System for Mobile Communications) based Device Tracking and Alert System. This system allows various device manufacturer companies to track their Devices in real-time and provides security from armed robbery and any incident occurrences.

4. Le-Tien, T.; Vu Phung describes a system based on the Global Positioning System (GPS) and Global System for Mobile Communication (GSM). It describes the practical model for routing and tracking with mobile device in a large area outdoor environment.

The system includes the RF transmitter to confirm moving direction of a Device. The system will acquire positions of the Device via GPS receiver and then sends the data to supervised center by the SMS (Short Message Services) or GPRS (General Package Radio Service) service. The supervised center comprises of a development kit that supports GSM techniques-WMP100 of the Wavcom Company. Finally, the position of the mobile or Device will be displayed on screen.

V. APPLICATIONS

- PROVIDE SECURITY TO VEHICLES
- TAKING CARE OF THE ELDERLY
- POLICE & PRIVATE DETECTIVES
- CAMPING ENTHUSIASTS

- COMPANY VEHICLE FLEET TRACKING
- PETS
- PAINTING/ARTWORK SECURITY

VI. FUTURE SCOPE

- The size of the object reduces with the time, the background becomes more dominant than the object being tracked.
- Latitude longitude coordinates display in form of global map at receiver site.
- Multi-view tracking can be implemented using multiple cameras.

VII. RESULT





Fig 11: Tracking Device

VIII. CONCLUSION

Thus we have designed a Device tracking system using two technologies mainly GPS and Zigbee. The system is already exist but only limited to GPS that is only get Latitude and Longitude Coordinates and track them. But we extend that system to add Zigbee technology which is capable of to confirm your exact location for minimizing searching time (Secondary confirmation to us). And also this system is capable in those places like a forest area there is no GPS signal to Find them our device. So,that time our Zigbee will work and within 200 meter range we can find our device easily. It offers to track not only portable devices but also for Pets, Painting/Artwork security, Camping enthusiasts and

Police-Private detectives. Future work is to reduce the size of system and Multiview tracking can be implemented using multiple cameras.

References

- [1]. Sharma, Rupam Kumar, et al. "Android interface based GSM home security system." *Issues and Challenges in Intelligent Computing Techniques (ICICT)*, 2014 International Conference on. IEEE, 2014.
- [2]. ALHMIEDAT, T.A. and YANG, S.H., 2008. A ZigBee-based Mobile tracking system through wireless sensor networks. *International Journal of Advanced Mechatronic Systems*, 1(1), pp.63-70.
- [3]. Blumenthal, J., Grossmann, R., Golatowski, F. and Timmermann, D.(2007) 'Weighted centroid localization in ZigBee-based sensor networks', *Folien IEEE International Symposium on Intelligent Signal Processing, WISP, Madrid, Spain*.
- [4]. A. El- Rabbany, *Introduction to GPS: The Global Positioning System*, Norwood, MA: Artech House, 2006.
- [5]. M.Brain,"HowMicrocontroller Works," *HowStuffW* [Online]. Available:<http://www.howstuffworks.com/microprocessor>. [Accessed 10 12 2014].
- [6]. M. Ahmad Fuad and M. Driberg, "Remote vehicle tracking system using GSM Modem and Google map," in *IEEE Conference on Sustainable Utilization and Development in Engineering and Technology (CSUDET)*, Selangor , 2013.
- [7]. M. Parvez, K. Ahmed, Q. Mahfuz and M. Rahman, "A theoretical model of GSM network based vehicle tracking system," in *International Conference on Electrical and Computer Engineering (ICECE)*, Dhaka, 2010.
- [8]. R.Ramani, S.Valarmathy, D. N.SuthanthiraVanitha, S.Selvaraju and M.Thiruppathi.R Thangam,"Vehicle Tracking and Locking System Based on GSM and GPS," *I.J. Intelligent Systems and Applications*, vol. 09, pp. 89-93,
- [9]. P. P. Wankhade and P. S. Dahad, "Real Time Vehicle Locking and Tracking System using GSM and GPS Technology-An Anti-theft System,"

International Journal of Technology And Engineering System(IJTES), vol. 2, no. 3, 2011.

- [10]. P. Verma and J. Bhatia, "Design and Development of GPS-GSM based Tracking System with Googlemap based Monitoring," International Journal of Computer Science, Engineering and Applications (IJCSA), vol. 3, no. 2, June 2013.
- [11]. T. Le-Tien and V. Phung-The, "Routing and Tracking System for Mobile Vehicles in Large Area," Fifth IEEE International Symposium on Electronic Design, Test and Application, pp. 297-300, January 2010.

AUTHOR'S PROFILES



Mr. Prasad R. Joshi
(MTech Computer Science
and Engineering)
Godavari college of
Engineering, Jalgaon.
Email: prasadjoshi469@gmail.com.

CSE-07 Medical Imaging using Deep Learning

Jayashri J. Patil

M.Tech. Student Department of Computer Engineering

Mr. Rahul Gaikwad

gaikwad005@gmail.com

Asst. Professor Department of Computer Engineering

GF's Godavari College of Engineering

Jalgaon -425003, Maharashtra, India

Abstract—The role of data analytics in medical imaging has grown rapidly in the last decade. This has also prompted increasing interests in the generation of analytical, data driven models based on machine learning in medical imaging. Deep learning, a technique with its foundation in artificial neural networks, is emerging in recent years as a powerful tool for machine learning, promising to reshape the future of artificial intelligence. Rapid improvements in computational power, fast data storage, and parallelization have also contributed to the rapid uptake of the technology in addition to its predictive power and ability to generate automatically optimized high-level features and semantic interpretation from the input data. This article presents a comprehensive up-to date review of research for deep learning in medical imaging providing a critical analysis of the tumor detection.

General Terms — deep learning, Tumor detection, Diabetic Retinopathy.

I. INTRODUCTION

In 1895, the German physicist, Wilhelm Röntgen, showed his wife Anna an X-ray of her hand. "I have seen my death," she said. Medical imaging broke paradigms when it first began more than 100 years ago, and deep learning medical applications that have evolved over the past few years seem poised to once again take us beyond our current reality and open up new possibilities in the field. Artificial intelligence (AI) deals in imaging and diagnostics are peaked in 2015 and have continued to hold steady. One third of healthcare AI startups raising venture capital post January 2015 have been working on imaging and diagnostics, and 80 percent of the funding deals took place thereafter. For instance, Enlitic, a startup which utilizes deep learning for medical image diagnosis, raised \$10 million in funding from Capitol Health in 2015.

IBM researchers estimate that medical images currently account for at least 90 percent of all medical data, making it the largest data source in the healthcare industry. This becomes an overwhelming amount on a human scale, when you consider that radiologists in some hospital emergency rooms are presented with thousands

of images daily. New methods are thus required to extract and represent data from those images more efficiently.

Though one of the most common early healthcare machine learning applications was actually in medical imaging, it's only recently that deep learning algorithms have been introduced that are able to learn from examples and prior knowledge. Though we haven't yet arrived at scale, such technologies are bringing society closer to more accurate and quicker diagnoses via deep learning-based medical imaging.

Current Deep Learning Medical Applications in Imaging

1] Tumor Detection

Over 5 million cases are diagnosed with skin cancer each year in the United States. The most commonly diagnosed cancer in the nation, skin cancer treatments cost the U.S. healthcare system over \$8 billion annually.

Melanoma (the deadliest form of skin cancer) is highly curable if diagnosed early and treated properly, with survival rates varying between 15 percent and 65 percent from early to terminal stages respectively. Proper treatment can even produce a 5-year survival rate of over 98 percent.

One of the most promising near-term applications of automated image processing is in *detecting* melanoma, says John Smith, senior manager for intelligent information systems at IBM Research. To detect the tumor, the DL algorithm learns important features related to the disease from a group of medical images and then makes predictions (i.e. detection) based on that learning.

Enlitic, the Australian-based medical imaging company referenced earlier, is considered an early pioneer in using DL for tumor detection, and its algorithms have been used to detect tumors in lung CT scans. Jeremy Howard, CEO of Enlitic, says his company was able to create an algorithm capable of identifying relevant characteristics of lung tumors with a higher accuracy rate than radiologists.

One thing that deep learning algorithms require is a lot of data, and the recent influx in data is one of the primary reasons for putting machine and deep learning back on the map in the last half decade. Yet lack of medical image data in the wider field is one barrier that still needs to be overcome. IBM was aware of this issue when it acquired Merge Healthcare, a company that helps hospitals store and analyze medical images, for \$1 billion in 2015. IBM has articulated its plans (see video below) to train Watson on Merge's collection of 30 billion images in order to help doctors in medical diagnosis.

A] Tracking Tumor Development

Medical imaging can also be used for non-invasive monitoring of disease burden and effectiveness of medical intervention, allowing clinical trials to be completed with smaller subject populations and thus reducing drug development costs and time.

Candidate regions in extracted tissues with proliferative activity, often represented as edges of a tissue abnormality, are identified. The DL algorithm generates tumor probability heatmaps, which show overlapping tissue patches classified for tumor probability. Such images provide informative data on different tumor features such as shape, area, density, and location, thus facilitating the tracking of tumor changes.

Researchers at the Fraunhofer Institute for Medical Image Computing (MEVIS) revealed a new tool in 2013 that employs DL to reveal changes in tumor images, enabling physicians to determine the course of cancer treatment. "The software can, for example, determine how the volume of a tumor changes over time and supports the detection of new tumors," said Mark Schenk from Fraunhofer MEVIS. Such an approach also has the potential to enable automated progress monitoring.

B] Blood Flow Quantification and Visualization

Magnetic Resonance Imaging (MRI) allows for the non-invasive visualization and quantification of blood flow in human vessels, without the use of contrast agents. When MRI's became more widely available in the 1980s, they enabled much more accurate evaluations of the impact of cardiovascular pathologies on local and global changes in cardiac hemodynamics.

Arterys, a DL medical imaging technology company, recently partnered with GE Healthcare to combine its quantification and medical imaging technology with GE Healthcare's magnetic resonance (MR) cardiac solutions. Arterys' system enables a much more efficient visualization and quantification of blood

flow inside the heart, alongside a comprehensive diagnosis of cardiovascular disease.

Arterys' DL software techniques have made it possible for cardiac assessments on GE MR systems to occur in a fraction of the time of conventional cardiac MR scans. The video below demonstrates Arterys' system:

C] Medical Interpretation

The benefits of a medical imaging test rely on both image and interpretation quality, with the latter being mainly handled by the radiologist; however, interpretation is prone to errors and can be limited, since humans suffer from factors like fatigue and distractions. This is one reason patients sometimes have different interpretations from various doctors, which can make choosing a plan of action a stressful and tedious process.

Metathesaurus (a large biomedical thesaurus) and RadLex (a unified language of radiology terms) can be used to detect disease-related words in radiological reports. A DL algorithm is then trained to detect the presence or absence of the disease in the medical images (i.e. radiology reports), helping doctors come up with better interpretations.

Lunit, a South Korean startup established in 2013, uses its DL algorithms to analyze and interpret X-ray and CT images. Lunit's system is able to provide interpretations in 5 seconds and with 95 percent accuracy, an achievement that has attracted investments of \$2.3 million through international startup incubation programs in just 3 years.

Another South Korean startup established in 2014, Vuno, is also helping doctors in medical image interpretations. Vuno uses its ML/DL technology to analyze the patient imaging data and compares it to a lexicon of already-processed medical data, letting doctors assess a patient's condition more quickly and provide better decisions. The startup's co-founders, who met while working at Samsung, realized that their machine learning experience could be applied to a more pressing problem: "Helping doctors and hospitals to combat disease by putting medical data to work."

2] Diabetic Retinopathy

Diabetic retinopathy (DR) is considered the most severe ocular complication of diabetes and is one of the leading and fastest growing causes of blindness throughout the world, with around 415 million diabetic patients at risk worldwide. Data from the National Health

Interview Survey and the US Census Bureau have lead to projections that the number of Americans 40 years or older having DR will triple from 5.5 million in 2005 to 16 million in 2050.

As with a many debilitating diseases, if detected early DR can be treated efficiently. A recent study published in 2016 by a group of Google researchers in the *Journal of the American Medical Association (JAMA)*, showed that their DL algorithm, which was trained on a large fundus image dataset, has been able to detect DR with more than 90 percent accuracy.

The DL algorithm shown in the study is trained on a neural network (a mathematical function with millions of parameters), which is used to compute diabetic retinopathy severity from the intensities of pixels (picture elements) in a fundus image, eventually resulting in a general function that is able to compute diabetic retinopathy severity on new images.

One of the things Google is currently working on with participating hospitals in India is implementing DL-trained models at scale, a contained trial in a grander effort to help doctors worldwide detect DR early enough for an efficient treatment.

Google's CEO, Sundar Pichal, talking about DR at the Google I/O 2016 event (at 4:57)

II. THE FUTURE

Search recent Quora and Reddit threads and you'll find that people seem to be concerned about the possibility for radiology to be disrupted by DL. Yet many experts express optimism at the possibilities for DL-based solutions in the medical imaging field. Dr. Bradley Erickson from the Mayo Clinic in Rochester, Minnesota, believes that most diagnostic imaging in the next 15 to 20 years will be done by computers. But he believes that instead of taking radiologists' jobs, DL will expand their roles in predicting disease and guiding treatment.

"I'm concerned that some people may dig in their heels and say, 'I'm just not going to let this happen.' I would say that noncooperation is also counterproductive, and I hope that there's a lot of physician engagement in this revolution that's happening in deep learning so that we implement it in the most optimal way," Erickson said. Dr. Nick Bryan, an Emeritus Professor of Radiology at Penn Medicine, seems to agree with Erickson, predicting that within 10 years no medical imaging exam will be reviewed by a radiologist until it has been pre-analyzed by a machine.

One of the most revolutionary future applications of DL would be in combatting most types of cancer.

Robert S. Merkel, Oncology and Genomics Global Leader at IBM Watson Health, discusses how IBM Watson will fight cancer

As part of this effort in the 'war on cancer', Google DeepMind has partnered with UK's National Health Service (NHS) to help doctors treat head and neck cancers more quickly with DL technologies. The research is being conducted in coordination with the University College London Hospital.

III. CLOSING THOUGHTS ON DEEP LEARNING IN MEDICAL IMAGING

In 2011, IBM Watson won against two of Jeopardy's greatest champions. In 2016, AlphaGo, a computer program developed by Google DeepMind to play the board game Go, won against Lee Se-dol, who is considered the strongest human Go player in the world.

While games function as important labs for testing DL technologies, IBM Watson and Google DeepMind have both carried over such solutions into the healthcare and medical imaging domains. It seems likely that as the technology develops further, many companies and startups will join bigger players in using ML/DL to help solve different medical imaging issues. Big vendors like GE Healthcare and Siemens have already made significant investments, and recent analysis by Blackford shows 20+ startups are also employing machine intelligence in medical imaging solutions.

While the potential benefits are significant, so are the initial efforts and costs, which is reason for big companies, hospitals, and research labs to come together in solving big medical imaging issues. IBM Watson, for instance, is partnering with more than 15 hospitals and companies using imaging technology in order to learn how *cognitive computing* can work in the real-world, a service Watson Health is expected to launch in 2017.

GE has also announced a 3-year partnership with UC San Francisco to develop a set of algorithms that help its radiologists distinguish between a normal result and one that requires further attention. This effort is in addition to another GE partnership with Boston's Children Hospital to create smart imaging technology for detecting pediatric brain disorders.

There are, and will remain, debates about radiology disruption and what it means for the future roles of medical practitioners; however, the potential benefits of applying deep learning toward the combatting and detecting of diseases and cancer seem likely to outweigh the foreseeable costs.

IV. CONCLUSION

Deep learning has gained a central position in recent years in machine learning and pattern recognition. In this paper, we have outlined how deep learning has enabled the development of more data-driven solutions in health informatics by allowing automatic generation of features that reduce the amount of human intervention in this process. This is advantageous form any problems in health informatics and has eventually supported a great leap forward for unstructured data such as those arising from medical imaging, medical informatics, and bioinformatics. Until now, most applications of deep learning to health informatics have involved processing health data as an unstructured source. Nonetheless, a significant amount of information is equally encoded in structured data such as EHRs, which provide a detailed picture of the patient's history, pathology, treatment, diagnosis, outcome, and the like. In the case of medical imaging, the cytological notes of a tumor diagnosis may include compelling information like its stage and spread. This information is beneficial to acquire a holistic view of a patient condition or disease and then be able to improve the quality of the obtained inference. In fact, robust inference through deep learning combined with artificial intelligence could ameliorate the reliability of clinical decision support systems. However, several technical challenges remain to be solved.

Patient and clinical data is costly to obtain and healthy control individuals represent a large fraction of a standard health dataset. Deep learning algorithms have mostly been employed in applications where the datasets were balanced, or, as a work-around, in which synthetic data was added to achieve equity. The later solution entails a further issue as regards the reliance of the fabricated biological data samples. Therefore, methodological aspects of NNs need to be revisited in this regard. Another concern is that deep learning predominantly depends on large amounts of training data. Such requirements make more critical the classical entry barriers of machine learning, i.e., data availability and privacy. Consequently, advances in the development of seamless and fast equipment for health monitoring and diagnoses will play a prominent role in future research. Reference to the issue of computational power, we envisage that for the years to come, further ad hoc hardware platforms for neural networks and deep learning processing will be announced and made commercially available. It is worth noting that the rise of deep learning has been mightily supported by major IT companies (e.g., Google, Facebook, and Baidu) which hold a large extent of patents in the field and core businesses are substantially supported by data gathering, enormous storehouses and processing machines. Many researchers have been encouraged to apply deep learning to any data-mining and pattern recognition problem related to health informatics in light of the wide availability of free packages to support this research. Looking at it from the bright side, it has fostered an interesting trend and boosted the expectations of what machine learning could

achieve on its own. Nevertheless, we should not consider deep learning as a silver bullet for every single challenge set by health informatics.

In practice, it is still questionable whether the large amount of training data and computational resources needed to run deep learning at full performance is worthwhile, considering other fast learning algorithms that may produce close performance with fewer resources, less parameterization, tuning, and higher interpretability. Therefore, we conclude that deep learning has provided a positive revival of NNs and connectionism from the genuine integration of the latest advances in parallel processing enabled by coprocessors. Nevertheless, a sustained concentration of health informatics research exclusively around deep learning could slow down the development of new machine learning algorithms with a more conscious use of computational resources and interpretability.

V. REFERENCES

- [1] R. Fakoor, F. Ladhak, A. Nazi, and M. Huber, "Using deep learning to enhance cancer diagnosis and classification," in Proc. Int. Conf. Mach. Learn., 2013, pp. 1–7.
- [2] B. Alipanahi, A. DeLong, M. T. Weirauch, and B. J. Frey, "Predicting the sequence specificities of DNA- and RNA-binding proteins by deep learning," *Nature Biotechnol.*, vol. 33, pp. 831–838, 2015.
- [3] P. Vincent, H. Larochelle, Y. Bengio, and P.-A. Manzagol, "Extracting and composing robust features with denoising autoencoders," in Proc. Int. Conf. Mach. Learn., 2008, pp. 1096–1103.
- [4]] H. R. Roth et al., "Improving computer-aided detection using convolutional neural networks and random view aggregation," *IEEE Trans. Med. Imag.*, vol. 35, no. 5, pp. 1170–1181, May 2016.
- [5] G. E. Hinton and R. R. Salakhutdinov, "Reducing the dimensionality of data with neural networks," *Science*, vol. 313, no. 5786, pp. 504–507, 2006.
- [6] C. Poulton et al., "Efficient learning of sparse representations with an energy-based model," in Proc. Adv. Neural Inf. Process. Syst., 2006, pp. 1137–1144.
- [7] P. Vincent, H. Larochelle, Y. Bengio, and P.-A. Manzagol, "Extracting and composing robust features with denoising autoencoders," in Proc. Int. Conf. Mach. Learn., 2008, pp. 1096–1103.
- [8] S. Rifai, P. Vincent, X. Muller, X. Glorot, and Y. Bengio, "Contractive auto-encoders: Explicit invariance

during feature extraction,” in Proc. Int. Conf. Mach. Learn., 2011, pp. 833–840.

[9] J. Masci, U. Meier, D. Cireşan, and J. Schmidhuber, “Stacked convolutional auto-encoders for hierarchical feature extraction,” in Proc. Int. Conf. Artif. Neural Netw., 2011, pp. 52–59.

[10] G. E. Hinton, S. Osindero, and Y.-W. Teh, “A fast learning algorithm for deep belief nets,” *Neural Comput.*, vol. 18, no. 7, pp. 1527–1554, 2006.

[11] R. Salakhutdinov and G. E. Hinton, “Deep boltzmann machines.” in Proc. Int. Conf. Artif. Intell. Stat., 2009, vol. 1, Art. no. 3.

[12] L. Younes, “On the convergence of markovian stochastic algorithms with rapidly decreasing ergodicity rates,” *Stochastics: An Int. J. Probab. Stochastic Process.*, vol. 65, no. 3/4, pp. 177–228, 1999.

[13] R. J. Williams and D. Zipser, “A learning algorithm for continually running fully recurrent neural networks,” *Neural Comput.*, vol. 1, no. 2, pp. 270–280, 1989.

[14] Y. LeCun, L. Bottou, Y. Bengio, and P. Haffner, “Gradient-based learning applied to document recognition,” *Proc. IEEE*, vol. 86, no. 11, pp. 2278–2324, Nov. 1998.

[15] Center Berkeley, “Caffe,” 2016. [Online]. Available: <http://caffe.berkeleyvision.org/>

[16] Y. Guo, Y. Liu, A. Oerlemans, S. Lao, S. Wu, and M. S. Lew, “Deep learning for visual understanding: A review,” *Neurocomput.*, vol. 187, pp. 27–48, 2016.

[17] K. Simonyan and A. Zisserman, “Very deep convolutional networks for large-scale image recognition,” *CoRR*, vol. abs/1409.1556, 2014. [Online]. Available: <http://arxiv.org/abs/1409.1556>

CSE-08 Software for Training and Placement

Ganesh Chavan¹, Supriya Pawar², Rahul Patil,³ Abhishek Somwanshi, Roshni Patil

Student, Computer Engineering, Gf's gcoe, jalgaon1,2,3,4,5

ganesh024@gmail.com

1 Assistant Professor Dept. of Computer science , Godavari College of Engineering, Jalgaon, India

2 Student, Dept. of Computer science , Godavari College of Engineering, Jalgaon, India.

1 Student, Dept. of Computer science , Godavari College of Engineering, Jalgaon, India

2 Student, Dept. of Computer science , Godavari College of Engineering, Jalgaon, India.

3 Student, Dept. of Computer science , Godavari College of Engineering, Jalgaon, India

ABSTRACT- *This project is aimed at developing a Training and Placement Cell of the college. The system is an online application that can be accessed throughout the organization and outside as well with proper login provided. This system can be used as an application for the Training and placement officer (TPO) of the college to manage the student information with regards to placement. Students logging should be able to upload their information in the form of a Resume. Visitors/Company representatives logging in may also access or search any information put up by Students. The management of Training and Placement is supported by paper-based systems, databases, spreadsheets and E-mail communications. The aim of this project is Automation of Training and Placement. The project will include minimum manual work and maximum optimization, abstraction and security. This is a web application which will help students as well as the administration authority to carry out each and every activity in this department.*

I. INTRODUCTION

In the present day's world everyone is travelling for jobs after Completion of their graduation. It has become need for each and every students ,but for that they need to travel worldwide in searching of jobs.For simplicity of this whole hectic procedures we had proposed Online Training and Placement System because of earlier system is totally done manually by maintaining records,time consuming and very difficult to maintain coordination between student and companies.

In our proposed you will save time as well as money as its web based application. We can collect information of all college students and fetch them according to criteria given by company. We have three modules

Admin/Training and Placement Officer(TPO),Student, Company. Admin has full access reserved over the system. Student's can mainly upload their CV and can download resources by Admin/TPO and Company .Company can register and give their criteria for placement.

II .LITERATURE SURVEY

This system can be used as an application for the Training and Placement Officers(TPO) of the college to manage the student information with regard to placement. Students logging should be able to upload their information in the form of a CV. The key feature of this project is that it is a onetime registration. The application provides the facility of maintaining the details of the students. It also provides requested list of candidates to recruit the students based on given query. Administrator logging in may also search any

information put up by the students. This project will aid colleges to practice full IT deployment. This will also help in fast access procedures in placement related activities. This led to a unique web-based placement management system developed specifically by the placements practitioner and the software programmer to become Online Training and Placement System.

III. PROPOSED SYSTEM

The Proposed system is a browser which is completely related to internet browsing. The web enabled information recruitment system designed to automate the entire operations of a modern. This maintains and controls the online learning and recruitment details and does online operations and generates various reports.

This system allows multi-divisional, handling that includes various activities. In this system it gives the entire reports of the account and there details.

Advantages over Existing System

- I. The proposed system is automated that is faster than the existing manually maintained system and can handle data easily.
- II. Computerization of the details of the members and recruitment operations.
- III. The System allow administrator to control all the activities hence identifying the roles and accessibility of other users.
- IV. Accurate information can be generated easily and quickly at different levels.
- V. Report can be generated easily and quickly.
- VI. Secured sign in and updates.

Need:

The need of our project Software for Training and Placement are as:

- i. The main aim of developing this website was to reduce maximum chances of errors in manual work.
- ii. Save time for the process.
- iii. Also students get notified by the SMS instantly.

The users can access easily to this and the data can be retrieved easily in no time. In the student registration form, we can give personal details, educational qualifications, and professional skills and upload resume. The job details of the placed students will be provided by the administrator. The job provider and the placements coordinator to take effective actions on the web as follow-on from the information they have viewed. The administrator plays an important role in our project. He provides approval of student registration and updating.

IV. TECHNOLOGY

HTML

HTML (Hypertext Markup Language). It provides the structure of text-based information in a document by denoting certain text as headings, paragraphs, lists, and so on and to supplement that text with interactive forms, embedded images, and other objects. HTML is written in

the form of labels (known as tags), surrounded by angle brackets.

JavaScript

JavaScript is a script-based programming language that was developed by Netscape Communication Corporation. JavaScript was originally called Live Script and renamed as JavaScript to indicate its relationship with Java. JavaScript supports the development of both client and server components of Web-based applications.

SERVLETS

The Java web server is JavaSoft's own web Server. The Java web server is just a part of a larger framework, intended to provide you not just with a web server, but also with tools. To build customized network servers for any Internet or Intranet client/server system. Servlets are to a web server, how applets are to the browser.

Eclipse IDE

Eclipse is an open-source software framework written primarily in Java. In its default form it is an Integrated Development Environment (IDE) for Java developers, consisting of the Java Development Tools (JDT) and the Eclipse Compiler for Java (ECJ).

V.DESIGN

In the design of Training and Placement Cell we tend to designed two users TPO and Student. Training and Placement officer and Student were produce a placement cell module through the net and these are keep within the information. In the Placement officer and Student operations, the coed will register his details and send to the location officer for applying the roles. Then the officer's post-employment for student weather they'll settle for or decline the task post then they were attending the actual drive.

The Training and Placement Cell Officer was conducting the drive those are through for interview

publish select list for college students. The colleges were checking the chosen list for drives conducted.

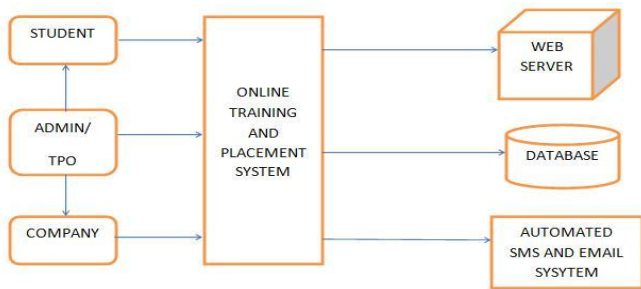

Fig 1. Block diagram of Training and placement

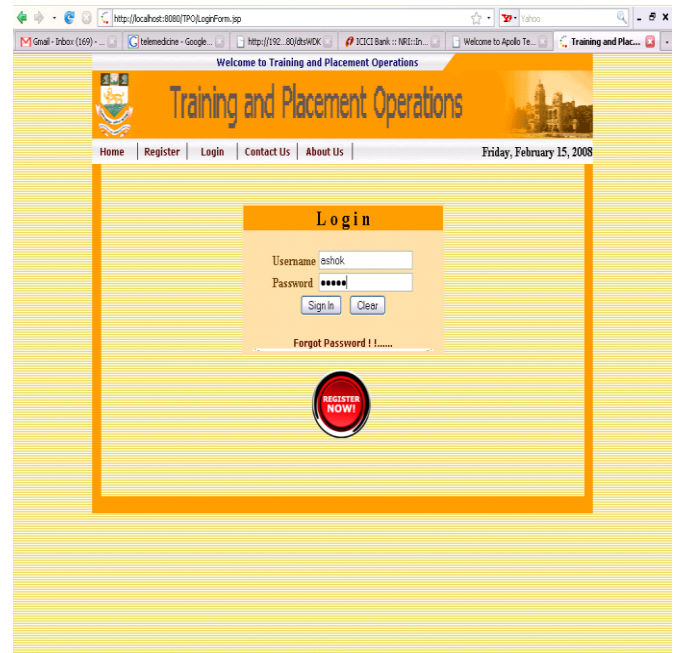

Fig 1.Login page

Fig 1 shows login window

VI .IMPLEMENTATION

The term Implementation has different meanings ranging from the conversation of a basic application to a complete replacement of a computer system. The procedures, however, are virtually the same. Implementation includes all those activities that take place to convert from old systems to new. The new system may be totally new replacing an existing manual or automated system or it may be a major modification to an existing system. The method of implementation and time scale to be adopted is found out initially. Next, the system is tested properly and at the same time, the users are trained in the new procedure. Proper implementation is essential to provide a reliable system to meet organization requirement.

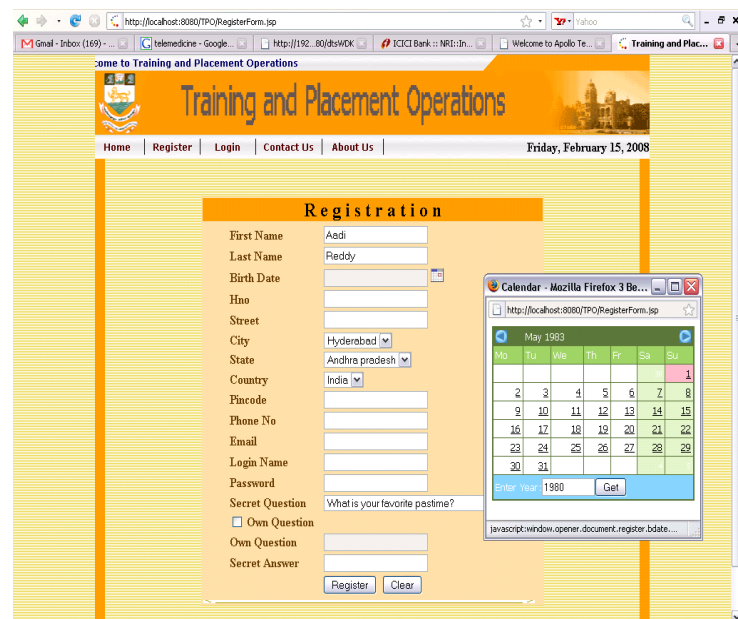

Fig.2 Registration page

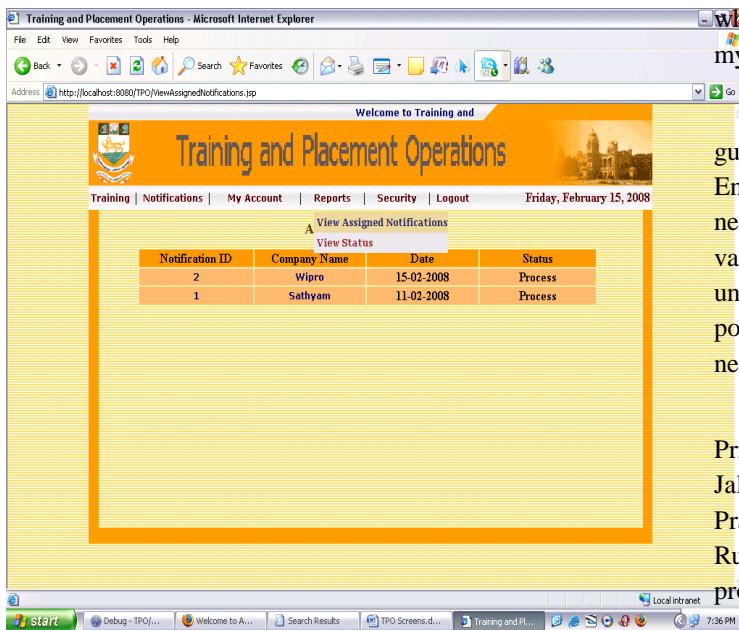

Fig.3 Notification page

Fig shows Notification page

CONCLUSION

As the technology is growing at a faster rate the usage of manual system is reduced. We have planned to develop automation for Training Placement Cell Automation this automation is developed based on web application so the training and placement cell works are processed within or without the organization with authorized people. In placement cell the records are maintained in paper formats and tedious work to short list the students according to the company requirements. To overcome this problem, records of the students are updated by the authorized administrator. There will be unique user name and password for the administrator. The student only views the details of the records. Only the authorized administrator should have the rights to insert, delete and update information into the data base and must short list the candidates required for the company.

ACKNOWLEDGMENT

We would like to acknowledge all the people who have been of the help and assisted me throughout my project work.

First of all we would like to thank my respected guide Prof. Ganesh Chavan in Department of Computer Engineering for introducing me throughout features needed. The time-to-time guidance, encouragement, and valuable suggestions received from him are unforgettable in our life. This work would not have been possible without the enthusiastic response, insight, and new ideas from him.

We gladly take this opportunity to thank Principal in GF s Godavari College of Engineering, Jalgaon and the H.O.D of Computer department Prof. Pramod Gosavi and The project-I In-charge Miss. Rupal Patil for providing all the facilities during the progress of project.

We would like to thank my lovely parents for time-to-time support and encouragement and valuable suggestions, for the emotional as well as strong support each and every time also for continued loving care and emotional support at every stage of this project.

The acknowledgement would be incomplete without mention of the blessing of the Almighty, which helped me in keeping high moral during most difficult period

REFERENCES

- [1] Nilesh Rathod, Seema Shah, Kavita Shirsat (2013), An Interactive Online Training and Placement System, IJARCSSE, Volume 3, December 2013, pp 505-511.
- [2] Talaba, D., Moja, A, Zirra, E., Guidelines towards a European standard for quality assurance of student placement.
- [3] Ashwajit Ramteke, Mrunal Deogade, Prafull Deogade(2015), STUDENT AUTOMATION SYSTEM FOR PLACEMENT CELL, IORD Journal of Science & Technology, Volume 2,Jan-Feb 2015, PP 104-109.
- [4] Zirra E., March F., Building University - Enterprise Cooperation for the Benefit of Students, Enterprises and Companies. EU-Net workshop, Athens 28 September (2006) Tynjala, P., Perspective into learning at the workplace, Educational Research Review, 3, 2008, pp.130-154.

- [5] [5] Talaba D., University-Industry cooperation in the Knowledge based society. Proceedings of the 2nd International EUI-Net
- [6] Conference on: Teaching and Research Synergy”, 4-6 May, Tallinn, pp.7-13. (2006).

National Conference on Current Trends in Engineering, Science and Technology (NACCTEST- 2018)
 Organized by GF's Godavari College of Engineering, Jalgaon
International Journal of Innovations in Engineering and Science, Special Conference Issue, 2018
 www.ijies.net

CSE-09 Campus Navigation Android Application

Iqbal S. Malik, Kinjal Mali, Bhushan Barapatre, Minal Pawar

Student B.E Computer

Mr. Rahul Gaikwad

gaikwad005@gmail.com

Asst. Professor Computer Engineering Dept.

GF's Godavari College Of Engineering, Jalgaon, India, 425001

Abstract –Global Positioning System is the most important contribution in determining position of user and in direction-finding him to his target. This system uses satellites to triangulate the position of the device. Though this system has made a good impression in terms of accuracy and is the preferred location based system for outdoor positioning, when it comes to indoor environment, GPS has proved to be incompetent. The reason for its inadequacy is that in order for GPS to perform a triangulation, the appliance needs to be in line-of-sight from the satellites. Moreover, GPS system has a low eminence which make it not appropriate for indoor areas. Therefore, when it comes to indoor positioning system, other alternatives such as Bluetooth, Wi-Fi, RFID and Infrared are more pleasing. This project proposes to implement a mobile application which will be able to estimate the position of a user within a building using WiFi technology.

The Indoor Navigation Framework we have proposed allows any wheelchair user to be guided to a desired location on his own, as long as the building itself is adopted to the novel system. Unlike the state of the art, where no automation exists for guiding a wheelchair in modern buildings.

Keywords: Framework, Indoor, Localization, Mapping, Navigation, Robotics.

INTRODUCTION

1.1 Project Context

Within living memory the domain of navigation is of great interest and was regular researched and further developed. Nowadays, navigation and the possibilities provided by it have only very little in common with the orientation at landmarks and simple

maps back then. Prerequisite for the development of navigation systems are sophisticated positioning methods which are able to provide the current location of a user or device with an adequate accuracy for a given context. Various technologies are available for different fields of application. The accuracy of these technologies range from several meters, up to a some centimeters, depending on the specific context. With the Global Positioning System (GPS), the Galileo system and other satellite navigation systems, several globally operating positioning technologies are available nowadays. These systems already proved its suitability for daily use in various products, such as car navigation systems and smart phones, or will do so soon. In most environments the globally operating positioning systems work well. However, in specific areas, such as urban neighborhoods (so called urban canyons) and indoor environments, these systems operate unreliably or, in the worst case, not at all. Various technologies are available to determine the location of a user or device in a local manner. These technologies are often based on optical, acoustic, or radio methods. Depending on the area of application and the specific environment these systems have various advantages and disadvantages. As Lorenz and Ohlbach [LO06, p. 102] state, “car navigation systems are becoming more or less standard commodity nowadays [... and ...] the problem of navigating car through large road networks has been well investigated and the solutions are mature”. Less investigated is the domain of navigating pedestrians through indoor environments. An actively assisted indoor navigation system would be beneficial, especially in large buildings, such as airports, hospitals, supermarkets, and office buildings. Due to the wide distribution of smart phones and the numerous possibilities that those provide, this device class represent

National Conference on Current Trends in Engineering, Science and Technology (NACCTEST- 2018)
 Organized by GF's Godavari College of Engineering, Jalgaon
International Journal of Innovations in Engineering and Science, Special Conference Issue, 2018
 www.ijies.net

a suitable platform to implement an indoor navigation system. Multiple sensors and external services can be utilized to determine a location as accurately as possible. The location information can be used within the navigation.

METHODOLOGY

A. Wi-Fi tri-lateration

The tri-lateration method uses parameters of known Wi-Fi networks like a frequency of Wi-Fi signal, its signal strength, the network MAC-address and real coordinates of Wi-Fi access points in the location. The received by mobile device signal strength can be used for distance estimation between the access point and mobile device. By using this method one considers three or more access points allocated in the building. The signal strengths of this point are decreasing exponentially depends on distance between transmitter and receiver and random noise factor. Thus this dependency can be considered as function of distance. The distance estimated by signal strength is presented as a circle with a radius around the access point. The intersection of three access point radii provides a point or an area of receiver. This model can be shown as such equation system.

$$d_1^2 = (x-x_1)^2 + (y-y_1)^2$$

$$d_2^2 = (x-x_2)^2 + (y-y_2)^2$$

$$d_3^2 = (x-x_3)^2 + (y-y_3)^2$$

B. Wi-Fi trilateration based on signal propagation model:

The simplest way for estimation distances between receiver and transmitter is a using of free-space path loss model [2, 5]: where, d is the transmitter-receiver separation distance in meters, f is the signal frequency in megahertz, FSPL is received signal strength path loss in dBm. During the implementation average real RSS measurements for one access point produced by Android application are compared with measurements calculated by equation 1. The measurements made for distances from 1 to 6 meters in 6 points along one line within the room in which Wi-Fi access point is allocated. The signal strength is measured 10 times for each of these 6 points. The area of the room is 25 square meters. The comparison is produced for the network with signal frequency 2412 MHz and is shown in Table I. Presented

in the table comparison results show that the free-space loss model is not effective for using even within the one room because the high difference between real and estimated values. This approach requires another path loss model that would provide higher accuracy

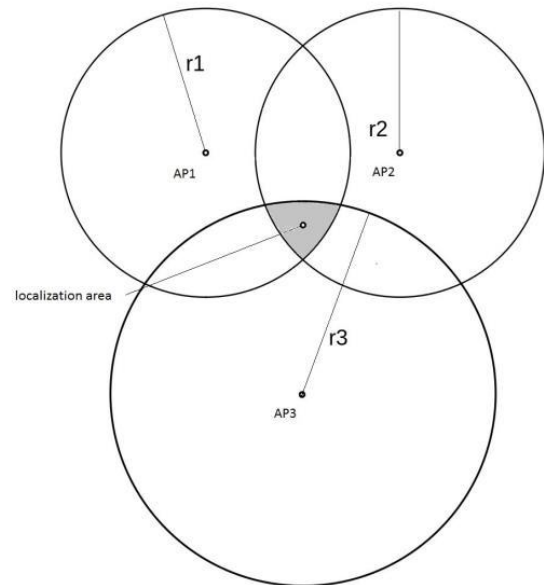

Fig. 1. Indoor localization area provided by trilateration approach

TABLE I. THE COMPARISON REAL AND ESTIMATED RSS

Distance, m	Real RSS, dBm	Estimated RSS, dBm
1	33.3	46.0
2	45.7	53.0
3	50.9	56.5
4	51.7	59.0
5	51.8	60.9
6	53.4	62.5

C. Wi-Fi trilateration based on RSS measurement Collection

In presented paper signal strength levels was measured by distance of three access points allocated in the three rooms within the floor. This data are collected to distance estimation for trilateration method described above. These measurements are made in 15 points at the 1 meter interval for each access point using developed Android application. This application found three different access points by MAC addresses and measured the RSS levels 10 times for each of 15 distances for every access point. The RSS level changes at time therefore it is necessary to use its average value. The AP RSS levels are displayed in the Table II.

National Conference on Current Trends in Engineering, Science and Technology (NACCTEST- 2018)
 Organized by GF's Godavari College of Engineering, Jalgaon
International Journal of Innovations in Engineering and Science, Special Conference Issue, 2018
 www.ijies.net

TABLE II. THE RSS MEASURE RESULTS FOR THREE ACCESS POINTS

Distance, m	AP1 RSS, dBm	AP2 RSS, dBm	AP3 RSS, dBm
1	33.3	38.8	55.3
2	45.7	43.1	50.3
3	50.9	48.9	65.7
4	51.7	55.2	61.2
5	51.8	75.1	62.5
6	53.4	75.5	66.4
7	57.8	76.4	70.5
8	62.4	80.8	72.3
9	65.7	80.8	74.7
10	62.9	76.0	78.0
11	72.9	88.6	76.07
12	72.7	88.2	86.02
13	63.9	91.0	79.03
14	74.0	91.9	85.08
15	76.7	92.1	82.05

Proceeded measurement points may be selected for distance estimation as reference points. The reference points are the points with RSS level difference more than Observational error calculated for each of 15 measurement points. Thus it is possible to determine the distance by the RSS as a segment between two values (Fig. 2). The observational error is calculated by formula:

$$\Delta = \sqrt{(\sigma \cdot t)^2 + A^2}$$

For localization the Android-based application is used that calculates an intersection of circle areas corresponding to estimated RSS level. This application uses java.awt library for building geometrical primitives and founding these intersections.

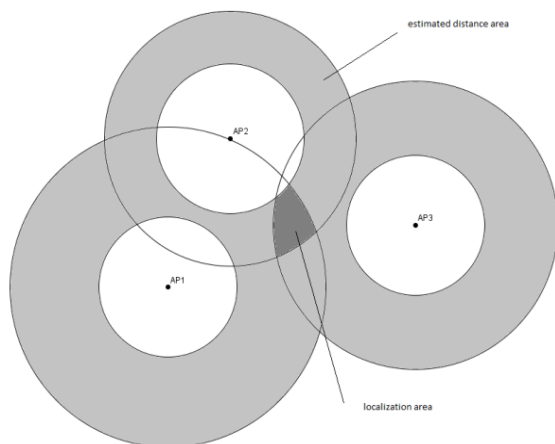

DESIGN

Location Fingerprinting

The WiFi network inside a building makes it possible to distinguish different locations as they would receive different strengths from various routers. The received signal strengths thus act as a fingerprint for a

location. Location fingerprinting based positioning systems usually works in two phases: calibration and positioning. In calibration phase, several positions inside a building are chosen and RSS values from the different access points are recorded. Each of the n measurements become a part of a radio map and is a tuple.

$$(q_i, r_i) \quad i = 1, 2, \dots, n$$

Where

$$q_i = (x_i, y_i)$$

are the geographical coordinates of the ith location and

$$r_i = (r_{i1}, r_{i2}, \dots, r_{im})$$

are the m RSS values from m access points at that location.

In positioning phase, the RSS values are recorded from n unknown location and a location estimator algorithm is used to and its coordinates from the previously created radio map.

Weighted k-Nearest Neighbours (WKNN)

The location estimator algorithm being used is the weighted k Nearest Neighbours Algorithm [5]. It is a two step process:

1. Find out the k nearest neighbours in the radio map

Input: Set of all n readings from calibration phase

$$(q_1, r_1), (q_2, r_2), \dots, (q_n, r_n)$$

Reading from current unknown location, r

Output:

Set of k nearest points.

Procedure:

Sort the n points in increasing order of Euclidean distance with current reading r. Euclidean distance is calculated by considering the readings as vectors.

Return first k readings in the sorted list

$$(q_1, r_1), (q_2, r_2) \dots (q_k, r_k)$$

2. Calculate the coordinates of the current unknown location

National Conference on Current Trends in Engineering, Science and Technology (NACCTEST- 2018)
Organized by GF's Godavari College of Engineering, Jalgaon
International Journal of Innovations in Engineering and Science, Special Conference Issue, 2018
www.ijies.net

Input:

Set of k nearest points

$$(q_1, r_1), (q_2, r_2) \dots (q_k, r_k)$$

Output:

Coordinate of current unknown location

Procedure:

Calculate coordinates using the formula

$$q = \sum_{j=1}^k \frac{w_j q_j}{\sum_{l=1}^k w_l}$$

Where all weights are nonnegative

$$w_j = d_{(r_i, r)}^{-1}$$

d is the Euclidean distance between the readings.

q_j is the coordinates of the j th location

WKNN has one tuning parameter, the number of nearest neighbours considered (k), which is used to control the locality of the location calculation. When $k = 1$, the algorithm acts as a simple look-up table.

For larger values, the location will be estimated to be somewhere in-between the calibration points.

`Practical Difficulties

Various factors influence the level of accuracy of the system in practice, these were identified and their effects were minimized to the possible extend.

1. Fluctuating Received Signal Strength (RSS) readings:

The readings taken from a particular location could fluctuate often and can result in errors. This could be rectified by using the average of several readings from the same location

2. Identifying reliable Access points

The access points considered for positioning purpose should be a permanent part of the structure and ideally be available at all times. Including temporary hotspots into the system should be avoided as they could negatively impact the calculations if they were relocated.

3. Orientation of users

The orientation in which the user holds the smart phone can alter the signal strengths received at that location. This can be accounted to the users body obstructing the signals from one particular direction. Orientation specific readings should be taken in the calibration phase to counter this factor.

4. Proper positioning of Access points

The access points inside a building should be positioned in such a way that each location is uniquely identified in terms of the WiFi fingerprint described earlier. But there is limitation regarding what can be done in this matter.

Work Done

To perform the experiments, a prototype Android application of an indoor positioning system that works entirely on the users device (without requirement to have a back-end server) was developed. The application allows determining the position of the device using a prepared radio map and device built-in Wi-Fi chipset. The application works in the two location fingerprinting phases calibration phase and positioning case.

During the calibrations phase, user can select the reliable access points for that particular building.

This rules out readings from other access points from being considered for calculation. The experiment was done inside the top floor of CSED Lab building. The floor was divided into 5 grids as shown in Figure 1. In the calibration phase, the available Wi-Fi access point RSSs are measured from different positions in the building. The measurements were taken for a defined period of time 30 seconds (readings became much more consistent then) and after that the average value is calculated and stored into the radio map.

In positioning phase, the application determines the actual position. RSS values of all the sensed APs are measured and compared to the ones in the prepared radio map to get the nearest neighbor. The nearest neighbor will be shown as a colored grid in the floor map. This method only uses the radio map as a look up table.

In calibration phase, the application has the following functionality:

1. Create/Remove a building
2. View/Add/Remove points to the selected building.
3. Perform fingerprinting by selecting the point from the list.

National Conference on Current Trends in Engineering, Science and Technology (NACCTEST- 2018)
Organized by GF's Godavari College of Engineering, Jalgaon
International Journal of Innovations in Engineering and Science, Special Conference Issue, 2018
www.ijies.net

4. Add/Remove reliable access points from the list of available accesspoints.

Functionality in the positioning phase:

1. Load and view map of the building.

2. Estimate position (in the form of grids as marked in the loaded map).

The readings taken from the calibration phase and the friendly WiFilst are backed up to a server and this enables new users to skip this phasebydownloading these already calibrated readings.

At the time of positioning, the WiFi access points in the vicinity of the new device is compared with the saved points to dynamically ascertain the building and our map to be loaded in the application.

A web page is created that saves the latest positions of all devices and allows users with proper privilege to view them.

CONCLUSION

The RSS Value at a particular location varies from device to device. So proper normalization of the readings should be done to get the application to work seamlessly in different devices.

Orientation specific values should be stored to the database in the calibrations phase. Only the values corresponding to the current orientation of the user (obtained from device sensors) should be considered in the positioning phase.

The second part of WKNN algorithm has to be implemented to get the users coordinates in between the chosen points from calibration phase.

The Wi-Fi trilateration method is using for indoor positioning and provides low accurate localization. For its improving can be used more accurate signal propagation models or expanded measures of signal strength including most number of reference point. Moreover, the further work can be continued on the Wi-Fi fingerprinting approach because the indoor localization algorithm described above may be considered as a special.

ACKNOWLEDGMENT

The presented results are a part of the research carried out within the project funded by grant 13-07-00336 of the Russian Foundation for Basic Research. This work was partially financially supported by Government of Russian Federation, Grant 074-U01 and Strategic Development Program of Petrozavodsk State University.

REFERENCES

- [1] Rui Zhang, A. Bannoura, F. Hoinger, L.M. Reindl, and C. Schindelhauer. Indoor localization using a smart phone. In *Sensors Applications Symposium (SAS), 2013 IEEE*.
- [2] Rui Zhang, A. Bannoura, F. Hoinger, L.M. Reindl, and C. Schindelhauer. Indoor localization using a smart phone. In *Sensors Applications Symposium (SAS), 2013 IEEE*.
- [3] E. S. Kim and Y. Kim. Geomagnetism-based indoor location estimation method for future smartphone. In *2012 IPIN*.
- [4] M. Angerman P. Robertson, MG. Puyol. Collaborative pedestrian mapping of buildings using inertial sensors and footslam. In *2011ION GNSS, 2011*.
- [5] VadimsuravovsGintsJkabsons, VadimKairish. An analysis of wifi based indoor positioning accuracy. In *Applied computer systems, Vol.47, Scienti_c Journal of the Series of Scienti_c Journal of RTU 2011, pages 131{137, 2011*.
- [6] Ilon, B. E. (1975). *Wheels for a Course Stable Selfpropelling Vehicle Movable in any Desired Direction on the Ground or Some Other Base. U.S. Patent. U.S.A.*
- [7] Everett, H.R. (1995). *Sensors for Mobile Robots: Theory and Application. A K Peters, Ltd, MA, USA.*
- [8] Diegel, O.; Badve, A.; Bright, G.; Potgieter, J. & Tlatle, S. (2002). *Improved Mecanum Wheel Design for Omni-directional Robots, Proc. 2002 Australian Conference on Robotics and Automation, Auckland, 27-29 Nov. 2002, pp. 117-121.*
- [9] Borenstein, J.; Everett, H.R. & Feng, L. (1996). *Navigating Mobile Robots: Sensors and Omni directional Mobile Robot – Design and Implementation IoanDoroftei, Victor Grosu and VeaceslavSpinu “Gh. Asachi” Technical University of Iasi Romania Techniques. A K Peters, Ltd, MA, USA.*
- [10] IoanDoroftei; Victor Grosu and VeaceslavSpinu; “Omnidirectional mobile robot- Design and Implimentation” from “Gh.Asachi” Technical university of Iasi, Romania.

CSE-10 Improved Data Mining Based Prediction of User Behavior through Sessions

Mr Tushar Kolhe, Mr Nilesh Y Choudhary, Mr Ashfaque Shaikh Rafique

1TusharKolhe

GF'S Godavari Engineering College India,425001

*² Mr Nilesh Y Choudhary , Assistant Professor,
cont.nilesh@gmail.com*

GF'S Godavari Engineering College India,425001

*³ Mr Ashfaque Shaikh Rafique , Assistant Professor,
sk.ashfaque.shaikh@gmail.com*

GF'S Godavari Engineering College India,425001

Abstract –

Users are increasingly pursuing complex task-oriented goals on the web, such as making travel arrangements, managing finances, or planning purchases. To this end, they usually break down the tasks into a few codependent steps and issue multiple queries around these steps repeatedly over long periods of time. To better support users in their long-term information quests on the web, search engines keep track of their queries and clicks while searching online. In this paper, we study the problem of organizing a user's historical queries into groups in a dynamic and automated fashion. Automatically identifying query groups is helpful for a number of different search engine components and applications, such as query suggestions, result ranking, query alterations, sessionization, and collaborative search. In our approach, we go beyond approaches that rely on textual similarity or time thresholds, and we propose a more robust approach that leverages search query logs. We experimentally study the performance of different techniques, and showcase their potential, especially when combined together.

Keywords

Energy efficient algorithm; Manets; total transmission energy; maximum number of hops; network lifetime

1. INTRODUCTION

AS the size and richness of information on the web grows, so does the variety and the complexity of tasks that users try to accomplish online. Users are no longer content with issuing simple navigational queries. Various studies on query logs (e.g., Yahoo's and AltaVista's) reveal that only about 20 percent of queries are navigational. The rest are informational or transactional in nature. This is because users now pursue much broader informational and task oriented goals such as arranging for future travel, managing their finances, or planning their purchase decisions. However, the primary means of accessing information online is still through keyword queries to a search engine. A complex

task such as travel arrangement has to be broken down into a number of codependent steps over a period of time. For instance, a user may first search on possible destinations, timeline, events, etc. After deciding when and where to go, the user may then search for the most suitable arrangements for air tickets, rental cars, lodging, meals, etc. Each step requires one or more queries, and each query results in one or more clicks on relevant pages

One important step toward enabling services and features that can help users during their complex search quests online is the capability to identify and group related queries together. Recently, some of the major search engines have introduced a new "Search History" feature, which allows users to track their online searches by recording their queries and clicks. For example, a portion of a user's history as it is shown by the Bing search engine on February of 2010. This history includes a sequence of four queries displayed in reverse chronological order together with their corresponding clicks. In addition to viewing their search history, users can manipulate it by manually editing and organizing related queries and clicks into groups, or by sharing them with their friends. While these features are helpful, the manual efforts involved can be disruptive and will be untenable as the search history gets longer over time. In fact, identifying groups of related queries has applications beyond helping the users to make sense and keep track of queries and clicks in their search history. First and foremost, query grouping allows the search engine to better understand a user's session and potentially tailor that user's search experience according to her needs. Once query groups have been identified, search engines can have a good representation of the search context behind the current query using queries and clicks in the corresponding query group. This will help to improve the quality of key components of search

engines such as query suggestions, result ranking, query alterations, sessionization, and collaborative search. For example, if a search engine knows that a current query "financial statement" belongs to a {"bank of America," "financial statement"} query group, it can boost the rank of the page that provides information about how to get a Bank of America statement instead of the Wikipedia article on "financial statement," or the pages related to financial statements from other banks. Query grouping can also assist other users by promoting task-level collaborative search. For instance, given a set of query groups created by expert users, we can select the ones that are highly relevant to the current user's query activity and recommend them to her. Explicit collaborative search can also be performed by allowing users in a trusted community to find, share and merge relevant query groups to perform larger, long-term tasks on the web.

Keywords- Energy efficient algorithm; Manets; total transmission energy; maximum number of hops; network lifetime

INTRODUCTION

AS the size and richness of information on the web grows, so does the variety and the complexity of tasks that users try to accomplish online. Users are no longer content with issuing simple navigational queries. Various studies on query logs (e.g., Yahoo's and AltaVista's) reveal that only about 20 percent of queries are navigational. The rest are informational or transactional in nature. This is because users now pursue much broader informational and task oriented goals such as arranging for future travel, managing their finances, or planning their purchase decisions. However, the primary means of accessing information online is still through keyword queries to a search engine. A complex task such as travel arrangement has to be broken down into a number of codependent steps over a period of time. For instance, a user may first search on possible destinations, timeline, events, etc. After deciding when and where to go, the user may then search for the most suitable arrangements for air tickets, rental cars, lodging, meals, etc. Each step requires one or more queries, and each query results in one or more clicks on relevant pages

One important step toward enabling services and features that can help users during their complex search quests online is the capability to identify and group related queries together. Recently, some of the major search engines have introduced a new "Search History" feature, which allows users to track their online searches

by recording their queries and clicks. For example, a portion of a user's history as it is shown by the Bing search engine on February of 2010. This history includes a sequence of four queries displayed in reverse chronological order together with their corresponding clicks. In addition to viewing their search history, users can manipulate it by manually editing and organizing related queries and clicks into groups, or by sharing them with their friends. While these features are helpful, the manual efforts involved can be disruptive and will be untenable as the search history gets longer over time. In fact, identifying groups of related queries has applications beyond helping the users to make sense and keep track of queries and clicks in their search history. First and foremost, query grouping allows the search engine to better understand a user's session and potentially tailor that user's search experience according to her needs. Once query groups have been identified, search engines can have a good representation of the search context behind the current query using queries and clicks in the corresponding query group. This will help to improve the quality of key components of search engines such as query suggestions, result ranking, query alterations, sessionization, and collaborative search. For example, if a search engine knows that a current query "financial statement" belongs to a {"bank of America," "financial statement"} query group, it can boost the rank of the page that provides information about how to get a Bank of America statement instead of the Wikipedia article on "financial statement," or the pages related to financial statements from other banks. Query grouping can also assist other users by promoting task-level collaborative search. For instance, given a set of query groups created by expert users, we can select the ones that are highly relevant to the current user's query activity and recommend them to her. Explicit collaborative search can also be performed by allowing users in a trusted community to find, share and merge relevant query groups to perform larger, long-term tasks on the web.

2. RELATED WORK

Web Content mining [3] deals with discovery of useful information from unstructured, semi structured or structured contents of web documents. Text, images, audio, video comprised by unstructured document, semi structured data includes HTML documents and lists and tables represent structured documents. The main aim of web content mining is to act as tool to retrieve information easily and quickly.

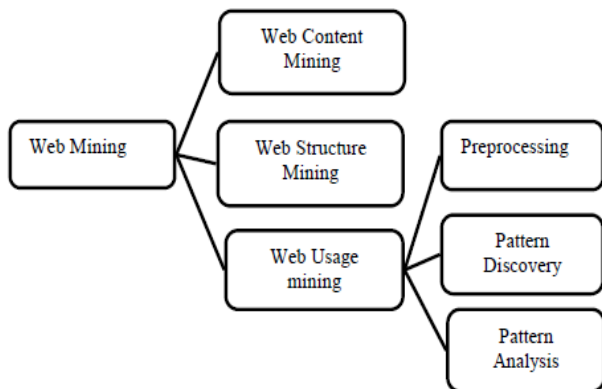

Fig 1: Web Mining Structure

Web Content Mining works by organizing a group of documents into related categories which helps web search engine to extract information more quickly and efficiently. Web Structure Mining [6], [7] mines the information by utilizing the link structure of the web documents. It works on inter document level and discovers hyperlink structure. It helps in describing the similarities and relationships between sites. Web Usage Mining [3] is a data mining technique that mines the information by analyzing the log files that contains the user access patterns. Web Usage Mining mines the secondary data which is present in log files and derived from the interactions of the users with the web. Web usage Mining techniques are applied on the data present in web server logs, browser logs, cookies, user profiles, bookmarks, mouse clicks etc. This information is often gathered automatically access web log through the Web server.

2.1 web usage mining

Web Usage Mining concentrates on the techniques that could predict the navigational pattern of the user while the user interacts with the web. It is mainly divided into two categories, they are general access pattern tracking and customized usage tracking. In general access pattern tracking information is discovered by using the history of web page visited by user while in customized usage tracking mining is targeted on specific user. Mainly there are four types of data sources present in which usage data is recorded at different levels they are: client level collection, browser level collection, server level collection and proxy level collection.

Client Level collection: At this level data is gathered together by means of java scripts or java applets. This data shows the behavior of a single user on single site.

Client side data collection requires user participation for enabling java scripts or java applets. The advantage of data collection at client side is that it can capture all clicks including pressing of back or reload button [2].

Browser Level Collection: Second method of data collection is by modifying the browser. It shows the behavior of single user over multiple sites. The data collection capabilities are enhanced by modifying the source code of existing browser. They provide much more versatile data as they consider the behavior of single user on multiple sites [2].

Server Level Collection: Web server log [5] stores the behavior of multiple users over single site. These log files can be stored in common log format or extended log format. Server logs are not able to store cached page views. Another technique used for usage data collection at server level is TCP/IP packet sniffing. Packet sniffers works by monitoring the net-work logs and retrieve usage data directly.

Proxy Level Collection: Proxy servers are used by internet service provider to provide World Wide Web access to customers. These server stores the behavior of multiple user at multiple site. These server functions like cache server and they are able to produce cached page views. By predicting the usage pattern of the visitor Web Usage Mining improves the quality of e-commerce services, personalizes the web [1] or enhances the performance of web structure and web server. Server data are data that are collected from web servers; it includes log files, cookies and explicit user input. Servers contain different types of logs, which are considered to be the main data resource for web usage mining.

Problem Definition

There are rich variants of browsing behavior analysis techniques are available but most of them are suffers from the following issues:

1. Web server access log based technique only contains the partial user behavior therefore need to improve the log management scheme
2. More than one pages are navigated in different times, therefore establishing the correlation between each user event and their corresponding web page is complex to learn by an algorithm
3. Huge data needs large time and space complexity
4. Inaccurate predictive methodology due to less number of feature availability on the user navigation pattern.

Limitations of Existing System:

1. Accuracy of system is quite less

2. Time consumption increase with increase in dataset size

Proposed Architecture

The framework consists of three Levels

Level 1: In this level the basic features are generated from web logs where proposed servers resides in and are used to form the web logs records for well-defined time period. Monitoring and analyzing logs to reduce the malicious activities only on relevant users & sessions. To provide a best protection for a targeted sessions. This also enables our detector to provide protection which is the best fit for the targeted users because legitimate user profiles used by the detectors are developed for a smaller number of logs.

Level 2: In this step the Analysis is applied in which the user profile Generation module is applied to extract the correlation between two separate features within individual log. The distinct features are come from level 1 or "feature normalization module" in this step. All the extracted correlation are stored, are then used to replace the original logs to represent the web logs. Its differentiating between legitimate and illegitimate log data.

Level 3: The anomaly session identification mechanism is adopted in decision making. Normal user profile generation module is to generate profiles for various types of web logs and the generated normal profiles are stored in a database. The "Tested Profile Generation" module is used in the "test phase" to build profiles for individual observed web logs. Then at last the tested profiles are handed over to "session identification" module it compares tested profile with stored normal profiles. This needs the expertise in the targeted detection algorithm and it is manual task. The Normal Profile Generation module is operated to generate profiles for various types of legal records of logs, and the normal profiles generated are stored in the database. The tested profile generation module is used in a Test Phase to build profiles for the each observed logs documentation. Next, the profiles of tested are passed over to an session identification part, which calculates the tested profiles for individual with the self-stored profiles of normal. A threshold based classifier is employed in the session identification portion module to classify logs [8]

A. Data Cleaning

Input: log_table

Output: refine_log_table

Begin

1. Read records in log_table
 2. For each record in log_table
 3. Read fields (Status code)
 4. If Status code=200, Then Get all fields.
 5. If suffix.URL_Link={*.gif,*.jpg,*.css,*.ico} then,
 6. Remove suffix.URL_link
 7. Save fields in new table.
- End if
- Else
8. Next record
- End if

End

B. Detection Mechanism

In this section, we present a threshold based on anomaly finder whose regular profiles are produced using purely legal records of web logs and utilized for the future distinguish with new incoming investigated logs report. The difference between an individual normal outline and a fresh arriving logs record is examined by the planned detector. If the variation is large than a pre-determined threshold, then a record of logs is marked as an malicious session otherwise it is marked as the legal session.

C. Algorithm for User Profile Generation

In this algorithm [1] the user normal profile is built through the density estimation between individual legitimate training web logs and the expectation of the legitimate training web logs.

Step 1: Input web logs.

Step 2: Extract original features of individual logs.

Step 3: Apply the concept user profile to extract the geometrical correlation between the jth and kth features in the vector xi.

Step 4: User Normal profile generation

- i. Generate triangle area map of each log.
- ii. Generate covariance matrix.
- iii Calculate features between legitimate record's Value and input records value
- Iv Calculate standard deviation.
- V Return pro.

Step 5: Session identification.

- i. Input: observed logs, normal profile and alpha.
- ii. Generate values for i/p logs
 Calculate value between normal profile and i/p Logs
- iv If value < threshold Detect Normal session
 Else
 Detect malicious session.

In the training phase, we employ only the normal records. Normal profiles are built with respect to the various types of appropriate logs using the algorithm describe below. Clearly, normal profiles and threshold points have the direct power on the performance of the threshold based detector. An underlying quality usual shape origins a mistaken characterization to correct logs.

D. Algorithm for Session identification

This algorithm is used for classification purpose.

Step1: Task is to classify new features as they arrive, i.e., decide to which class label they belong, based on the currently existing logs record.

Step2: Formulated our prior probability, so ready to classify a new record.

Step 3: Then we calculate the number of points in the record belonging to each logs record.

Step 4: Final classification is produced by combining both features of information, i.e., the prior and to form a posterior probability.

E. Mathematical Modeling

Let S be the system which we use to find the session identification system. They equip proposed detection system with capabilities of accurate characterization for logs behaviours and detection of known and unknown attacks respectively.

- Input: Given an arbitrary dataset $X = \{x_1, x_2, \dots, x_n\}$
- Output: DP (Detected Sessions) : $DP = \{n, m\}$
 Where n is normal sessions and M is the malicious sessions.

Process: $S = \{D, mvc, NP, AD, DP\}$ Where, S= System.

D= Dataset

mvc = Multivariate correlation analysis.

NP = Normal profile generation. AD =Session identification.

DP= Detected packets.

EXERPIMENT EVALUATION AND ANALYSIS

Evaluation of session identification is done by using web logs dataset. User Normal Profile is built by using same dataset. Threshold range is generated by using ' $\mu + \sigma * \alpha$ ' and ' $\mu - \sigma * \alpha$ ' For normal Distribution, the value of ' α ' ranges from 1 to 3. Detection rate and False positive rate is evaluated for the different values of ' α '.

Advantages of Proposed System:

1. Accuracy is high
2. Time consumption is very less as compared to previous systems
3. Classification accuracy is better than previous systems

Disadvantages of proposed system:

1. Does not consider real time dataset
2. Processing speed depends on the machine configuration

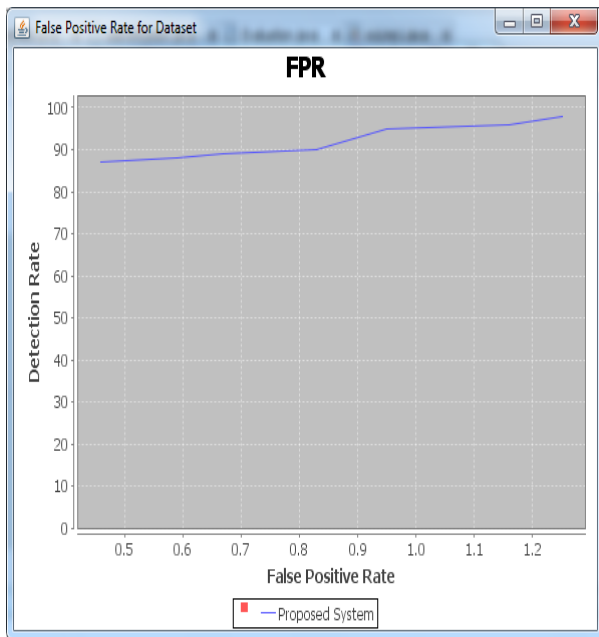

Fig: Graph for detection of False positive rate Vs. Detection rate

CONCLUSION

Web usage mining is indeed one of the emerging areas of research and important sub-domain of data mining and its techniques. In order to take full advantage of web usage mining and its all techniques, it is important to carry out preprocessing stage efficiently and effectively. This paper tries to deliver areas of preprocessing, including data cleansing, session identification, user identification. Once the preprocessing stage is well-performed, we have applied data mining technique classification. Web log mining is one of the recent areas of research in Data mining. Web Usage Mining becomes an important aspect in today's era because the quantity of data is continuously increasing. Above results shows that the detection rate of session identification is far better than previous systems and the false positive rate is very low. As the for changes there is certain deflection in detection rate also. Thus we prove that our system performs better on given dataset and also on real-time dataset generated from wire shark software tool. We deal with the web server logs which maintain the history of page requests. for applications of

web usage mining such as business intelligence, e-commerce, e-learning, personalization, etc.

FUTURE SCOPE

1. Can be implemented with other algorithms to check accuracy.
2. Hybrid approach can also be implemented to improve accuracy.
3. To be implemented using real world dataset.

REFERENCES

- [1] J. Teevan, E. Adar, R. Jones, and M.A.S. Potts, "Information Re-Retrieval: Repeat Queries in Yahoo's Logs," Proc. 30th Ann. Int'l ACM SIGIR Conf. Research and Development in Information Retrieval (SIGIR '07), pp. 151-158, 2007.
- [2] A. Broder, "A Taxonomy of Web Search," SIGIR Forum, vol. 36, no. 2, pp. 3-10, 2002.
- [3] A. Spink, M. Park, B.J. Jansen, and J. Pedersen, "Multitasking during Web Search Sessions," Information Processing and Management, vol. 42, no. 1, pp. 264-275, 2006.
- [4] R. Jones and K.L. Klinkner, "Beyond the Session Timeout: Automatic Hierarchical Segmentation of Search Topics in Query Logs," Proc. 17th ACM Conf. Information and Knowledge Management (CIKM), 2008. P. Boldi, F. Bonchi, C. Castillo, D. Donato, A. Gionis, and S. Vigna, "The Query-Flow Graph: Model and Applications," Proc. 17th ACM Conf. Information and Knowledge Management (CIKM), 2008.
- [6] D. Beeferman and A. Berger, "Agglomerative Clustering of a Search Engine Query Log," Proc. Sixth ACM SIGKDD Int'l Conf. Knowledge Discovery and Data Mining (KDD), 2000.
- [7] R. Baeza-Yates and A. Tiberi, "Extracting Semantic Relations from Query Logs," Proc. 13th ACM SIGKDD Int'l Conf. Knowledge Discovery and Data Mining (KDD), 2007.
- [8] J. Han and M. Kamber, Data Mining: Concepts and Techniques. Morgan Kaufmann, 2000.
- [9] W. Barbakh and C. Fyfe, "Online Clustering Algorithms," Int'l J. Neural Systems, vol. 18, no. 3, pp. 185-194, 2008.

[10] Lecture Notes in Data Mining, M. Berry, and M. Browne, eds. World Scientific Publishing Company, 2006.

[11] V.I. Levenshtein, "Binary Codes Capable of Correcting Deletions, Insertions and Reversals," Soviet Physics Doklady, vol. 10, pp. 707-710, 1966.

[12] M. Sahami and T.D. Heilman, "A Web-based Kernel Function for Measuring the Similarity of Short Text Snippets," Proc. the 15th Int'l Conf. World Wide Web (WWW '06), pp. 377-386, 2006.

[13] J.-R. Wen, J.-Y. Nie, and H.-J. Zhang, "Query Clustering Using User Logs," ACM Trans. in Information Systems, vol. 20, no. 1, pp. 59-81, 2002.

[14] A. Fuxman, P. Tsaparas, K. Achan, and R. Agrawal, "Using the Wisdom of the Crowds for Keyword Generation," Proc. the 17th Int'l Conf. World Wide Web (WWW '08), 2008.

[15] K. Avrachenkov, N. Litvak, D. Nemirovsky, and N. Osipova, "Monte Carlo Methods in PageRank Computation: When One Iteration Is Sufficient," SIAM J. Numerical Analysis, vol. 45, no. 2, pp. 890-904, 2007.

CSE-11 Survey on Predicting Instructor Performance using Data Mining Technique

Priya s. Patil¹, Nilesh Choudhary², Renuka Deshpande³

¹ PG Student

patilspriya2012@gmail.com

GF's Godavari COE Jalgaon (MS), India, 425001

² Assistant professor

cont.nilesh@gmail.com

GF's Godavari COE Jalgaon (MS), India, 425001

³ Assistant professor

GF's Godavari COE Jalgaon (MS), India, 425001

Abstract – Data mining applications are becoming a more common tool in understanding and solving educational and administrative problems in higher education. Generally, research in educational mining focuses on modeling student's performance instead of instructors' performance. One of the common tools to evaluate instructors' performance is the course evaluation questionnaire to evaluate based on students' perception. In this study, instructor's performance is based on student feedback and instructor feedback. classification algorithm of Naïve Bayes, K-Means clustering and C5.0 are used to build classifier models. Their performances are compared over a dataset composed of responses of students to a real course evaluation questionnaire, instructor feedback to a subject related questionnaire and students final examination results using accuracy, precision, recall, and specificity performance metrics. Although all the classifier models show comparably high classification performances, Naïve Bayes classifier is the best with respect to accuracy, precision, and specificity.

Keywords-Performance evaluation, students final examination results, C5.0, Naïve Bayes classifier, K-Means Clustering.

INTRODUCTION

Nowadays Data Mining (DM) has attracted a lot attention in data analysis area, and it became recognizable new tool for data analysis that can be used to extract valuable and meaningful knowledge from data.

DM offers promising ways to uncover hidden patterns within large amounts of data. These hidden patterns can potentially be used to predict future behavior. Accordingly, DM has been adopted by many researchers to solve real-world problems in various domains such as marketing, stock market, telecommunication, industrials, health care, medical and customer relationship. Recently a reasonable number of researches have been conducted to apply DM techniques in the education area in order to classify and predict student performance in numerous education institutes. Employing DM techniques in education is promising because of the tremendous opportunities in this area[2]. Recent national policies on higher education mandating high stakes evaluation of instructors and the learning system coupled with the quest for an optimal algorithm for evaluation of instructors' performance in higher institutions of learning especially in the developing countries are primary motivation for this work.

Higher education institutions are interested in predicting the paths of students and alumni, thus identifying which students will join particular course programs and which students will require a large number of debates. Nowadays, one of the biggest challenges that educational institutions face is the sudden growth of educational data and to use this data to improve the quality of managerial decisions. Data mining techniques are analytical tools that can be used to extract meaningful knowledge from these large data sets[4]. Moreover, education systems claim new approaches which improve quality, efficiency, and achievement. Mostly DM is utilized in education to investigate the impact of pedagogical strategies on students, and how students understand the course. The academic

performance of students based on several factors. The most important factors are the attributes such as the previous academic records, economic status, family background, and demographic data, and the prediction methods. Thus most of the research in this area relayed on the attributes specified student data[2]. The students feedback is an indirect assessment measuring tool which is extensively being used as an evaluation of teaching in the field of higher education[3]. This kind of feedback is not only beneficial for addressing students concerns but also facilitates appropriate enhancement activities undertaken by the institution. A variety of formal and informal procedures based on qualitative and quantitative methods are commonly used with the aim of identifying a variety of issues concerning faculty, curriculum, teaching methodology and essential support services for resolving the identified issues and for enhancing the overall quality of academic programs and services provided by the institution.

LITERATURE SURVEY

Mustafa Agaoglu[1] stated that there is an increased popularity of using data mining techniques in higher education, and because of its potentials to educational institutes such as better allocating resources, predicting student performance, academic planning and intervention transfer prediction, improving the effectiveness of alumni development, a new field called educational data mining has emerged. Educational data mining (EDM) is concerned with developing methods for exploring data from educational settings with the purpose of providing quality education to students. With EDM, additional insights can be gained from educational entities such as students, lecturers, staff, alumni, and managerial behaviour. These can be then used to allocate resources and staff more effectively, make better decisions on educational activities to improve students' success, increase students' learning outcome, increase student's retention rate, decrease students' drop-out rate, and reduce the cost of system processes

one of the common tools to evaluate instructors' performance is the course evaluation questionnaire to evaluate based on students' perception. In this approach, four different classification techniques decision tree algorithms, support vector machines, artificial neural networks, and discriminant analysis are utilized to manufacture classifier models. Their performances are compared over a data set composed of responses of

students to a real course evaluation questionnaire using accuracy, precision, recall, and specificity performance metrics. Although all the classifier models indicate equivalently high classification performances, C5.0 classifier is the best with respect to accuracy, precision, and specificity. This Methodology indicate the effectiveness and expressiveness of data mining models in course evaluation and higher education mining. Classification is one of the most common application domains of data mining. The main task in classification is assigning a class label among a set of possible class values to an unseen instance composed of a set of variables. It is done by using a classifier model, which is built by applying a learning algorithm on a training set composed of past instances having the same variable set as the unseen instance. However, the class label of each instance in the training set is clearly known before training. After learning phase, the classification performance of the classifier model built is evaluated on an independent test set before used.

Ahmed Mohamed Ahmed[2] stated that Data Mining (DM) has attracted a lot attention in data analysis area, and it became recognizable new tool for data analysis that can be used to extract valuable and meaningful knowledge from data. DM offers promising ways to uncover hidden patterns within large amounts of data. These hidden patterns can possibly be utilized to predict future behaviour. Accordingly, DM has been adopted by many researchers to solve real-world problems in various domains such as marketing, stock market, telecommunication, industrials, health care, medical and customer relationship. Recently a reasonable number of researches have been conducted to apply DM techniques in the education area in ordered to classify and predict student performance in numerous education institutes. Employing DM techniques in education is promising because of the tremendous opportunities in this area.

This philosophy predicting the instructor performance and investigates the factors that influence students achievements to improve the education system quality. Turkey Student Evaluation records dataset is considered and run on different data classifier such as J48 Decision Tree, Multilayer Perception, Naïve Bayes, and Sequential Minimal Optimization. Examination of all the four classifiers is led to predict the accuracy and to find the best performing classification algorithm among all.

Experiments are conducted in four consecutive steps. In step one, attribute evaluation is performed using the one algorithm to clarify which attribute has the greatest potential impact on every class in the dataset. In

step two, the attributes that have the highest impacts are selected and the four suggested DM techniques are conducted after removing the last ten attributes with lower impacts on the dataset. In step three, all dataset of Turkey Student Evaluation is tested and analyzed with the four classification algorithms J48 Decision Tree, Multilayer Perception, Naïve Bayes, and Sequential Minimal Optimization. The results show that J48 DT algorithm achieves the best performance compared to the other algorithms. In step four, some experiments are conducted in order to investigate the performance of instructors. The aim of this methodology is to determine the performance of each instructor individually and to investigate the factors that affect their achievements.

Monika Goyal[4] stated that data analysis plays an important role for decision support in education system. Data mining techniques are used to improve the efficiency of higher education institutions. If data mining techniques such as clustering, decision tree and association are applied to higher education processes, it would help to improve students' performance, their life cycle management, selection of courses, to measure their retention rate and the grant fund management of an institution. Higher education institutions are interested in predicting the paths of students and alumni, thus identifying which students will join particular course programs and which students will require a large number of debates. Data mining techniques are explanatory instruments that can be utilized to extract meaningful knowledge from these large data sets. To face these challenges different systems are used such as ERP, DWH etc.

Ahmad Ashari[5] stated that there are three classifiers used in this experiment namely Naïve Bayes, Decision Tree, and k-Nearest Neighbor. This experiment shows that Decision Tree is the fastest and k-Nearest Neighbor is the slowest. The fast classification time of Decision Tree because there is no calculation in its classification. The tree model is created outside the application that is using Weka data mining tool. And the model is converted into rules before being incorporated into the application. Classification by way of following the tree rules is faster than the ones that need calculation as in the case of Naïve Bayes and k-Nearest Neighbor. In the mean time k-Nearest Neighbor is the slowest classifier because the classification time is directly related to the number of data. The bigger the data, the larger distance calculations must be performed. This causes the classification is extremely slow. Although it is a simple method, Naïve Bayes can outperform more sophisticated classification methods. In this experiment,

Naïve Bayes outperforms Decision Tree and k-Nearest Neighbor.

PROPOSED SYSTEM

The study aims at using the classification method of Data mining for the prediction of teachers' performance. The prediction model was developed using the Classification methods of the Data mining technique. The K-Means clustering, C5.0 and Naive Bayes classification algorithm are used and their performances are compared to each other.

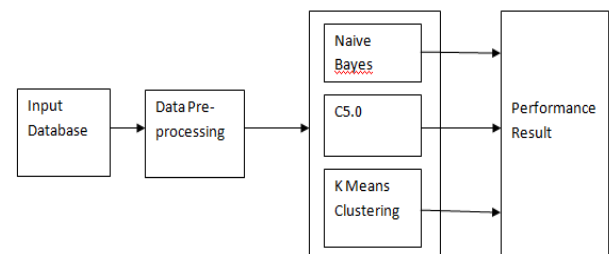

Fig: System Architecture

A. Data Acquisition

The raw data used in this study is collected from an Academic Department of a University or College. The data included three basic categories of variables, the first group consists of the teachers' data. The second group of variables includes the students' learning outcome in academics sessions. The third group of variables include the student feedback to real course.

B. Pre-processing data and feature extraction

The data pre-processing is carefully done to avoid incomplete records. The fields selected for the model include: Appointment status, Rank, University working experience, Highest Qualification, Year of last Qualification, Professional Qualification and Result. The instrument and variable selected for this work are based on pedagogical surveys, facts from literatures and experts in the domain.

C. System Design

The tasks involve decision tree and classification algorithms; hence in the research work a two-layered classifier system is designed to achieve the objective of the work. Layer 1 consists of decision tree c5.0 algorithm and layer 2 is made up of Naïve Bayes classifiers. These classifiers have been selected because

of their performances in various domains. They have both been successfully applied to a variety of real-world classification tasks in industry, business, science and education with good performances.

The advantages of Naive Bayes over C5.0 classifier are:

1. Since the classifier returns probabilities, it is simpler to apply these results to a wide variety of tasks than if an arbitrary scale was used.
2. It does not require large amounts of data before learning can begin.
3. Naive Bayes classifiers are computationally fast when making decisions.

CONCLUSION

The describe system provides the accurate performance of the staff and performances of classification algorithms used in building a model. This describe system implement model using naïve bayes classification, C5.0 decision tree algorithm and K-Means clustering algorithm. Naive bayes gives higher accuracy than C5.0 and K-Means clustering. Naïve Bayes can outperform more sophisticated classification methods. Based on Accuracy the performance of Naïve Bayes is the best. In this system Naïve Bayes outperforms Decision Tree and k-Means clustering.

REFERENCES

- [1]. Mustafa agaoglu" *Predicting Instructor Performance Using Data Mining Techniques in Higher Education*" volume 4, 2016 IEEE
- [2]. Ahmed Mohamed Ahmed, Ahmet Rizer, Ali Hakan Ulusoy" *Using data mining to predict instructor performance*" *International Conference on Application of Fuzzy Systems and Soft Computing, ICAFS 2016*
- [3]. Anwar Muhammad Abaidullah, Naseer Ahmed, and Edriss Ali "Identifying Hidden Patterns in Students Feedback through Cluster Analysis" *International Journal of Computer Theory and Engineering, Vol. 7, No. 1, February 2015*
- [4]. Monika Goyal and Rajan Vohra" *Applications of Data Mining in Higher Education*" *IJCSI International Journal of Computer Science Issues, Vol. 9, Issue 2, No 1, March 2012*
- [5]. Ahmad Ashari, Iman Paryudi, A Min Tjoa" *Performance Comparison between Naïve Bayes, Decision Tree and k-Nearest Neighbor in Searching Alternative Design in an Energy Simulation Tool*" *International Journal of Advanced Computer Science and Applications, Vol. 4, No. 11, 2013*
- [6]. Randa Kh. Hemaïd, Alaa M. El-Halees" *Improving Teacher Performance using Data Mining*" *International*

- Journal of Advanced Research in Computer and Communication Engineering Vol. 4, Issue 2, February 2015*
- [7]. B. Minaei-Bidgoli, D. A. Kashy, G. Kortemeyer, and W. F. Punch, "Predicting student performance: An application of data mining methods with an educational Web-based system," in *Proc. 33rd Annu. IEEE Frontiers Edu.*, vol. 1. Nov. 2003, p. T2A-13.
 - [8]. V. Kumar and A. Chadha, "An empirical study of the applications of data mining techniques in higher education," *Int. J. Adv. Computer. Sci. Appl.*, vol. 2, no. 3, pp. 80_84, 2011.
 - [9]. C. Romero and S. Ventura, "Educational data mining: A survey from 1995 to 2005," *Expert Syst. Appl.*, vol. 33, pp. 135_146, Jul. 2007.
 - [10]. B. K. Baradwaj and S. Pal, "Mining educational data to analyze students' performance," *Int. J. Adv. Comput. Sci. Appl.*, vol. 2, no. 6, pp. 63_69, 2011.
 - [11]. S. Calkins and M. Micari, "Less-than-perfect judges: Evaluating student evaluations," *NEA Higher Edu. J.*, pp. 7_22, Fall 2010.
 - [12]. J. Sojka, A. K. Gupta, and D. R. Deeter-Schmelz, "Student and faculty perceptions of student evaluations of teaching: A study of similarities and differences," *College Teach.*, vol. 20, no. 2, pp. 44_49, 2002.
 - [13]. L. Coburn. (1984). *Student Evaluation of Teacher Performance, ERIC/TME Update Series.* [Online]. Available: <http://ericae.net/edo/ED289887.htm>
 - [14]. S. A. Radmacher and D. J. Martin, "Identifying significant predictors of student evaluations of faculty through hierarchical regression analysis," *J. Psychol.*, vol. 135, no. 3, pp. 259_269, 2001.

CSE-12 Analysis of Multiple Link Failures in MPLS Network

PranitaShankhpal

M.Tech Student Department of Computer Engineering

Mr.RahulGaikwad

gaikwad005@gmail.com

Asst. Professor Department of computer Engineering

GF's Godavari College of Engineering

Jalgaon-425003, Maharashtra, India

ABSTRACT

MPLS stands for Multiprotocol Label Switching (MPLS). It provides significant benefits by fast forwarding packets. In MPLS, there is no admission control for nodes and it is connection-oriented network which makes network more reliable. If the network link is overloading with traffic or node leave network, failure can occur at any point of time then there is need to establish a new label switched path (LSP) and then forward the packets to the newly established LSP. From this survey analysis of various recovery mechanisms of MPLS based on some performance parameters. The parameters consider for analysis such as resource requirement, fault recovery time, packet loss ratio, packet re-ordering, complexity, optimal path option selection. The forwarding of failed link traffic to different or backup path this may leads LSP get more congested. Here some mechanisms used for to tolerate these link failures in MPLS network. The main focus to analyze the various mechanisms used for tolerates the link failure in MPLS based on the Quality of Service (QoS) parameters. The expected result from this thesis, the network should maintain connectivity after multiple failures without causing congestion.

INTRODUCTION:

The MPLS domain can be divided into MPLS core and MPLS edge. Multiprotocol Label Switching (MPLS) is an improved method for forwarding Internet Protocol (IP)

packetsthrough a network using information contained in labels. Nowadays IP based networks uses MPLS as backbone network for fast forwarding and switching of IP packets. The labels are inserted between the Layer 3 (network) header and the Layer 2 (data link layer) header, so it is also called 2.5 layer networks. Also Frame Relay (FR) and Asynchronous Transfer Mode (ATM) networks have many disadvantages in the management operation of large networks such as cost, security, scalability and flexibility; this can be overcome in MPLS network.

The nodes in the MPLS domain are called as LSRs (Label Switch Routers). The nodes in the core are called transit LSRs and the nodes in the MPLS edge are called LERs (Label Edge Routers). If a LER is the first node in the path for a packet travelling through the MPLS domain this node is called the ingress LER, if it is the last node in a path it's called the egress LER. This depends on the direction of traffic flow in the network, one node can therefore be both ingress and egress LER depending on which flow is considered in the network. The terms upstream and downstream routers are also used to indicate in which order the routers are forwarding the traffic flow. If a LSR is upstream from another LSR, traffic is passed through that LSR before the other (downstream). A schematic view of the MPLS domain is shown as follows.

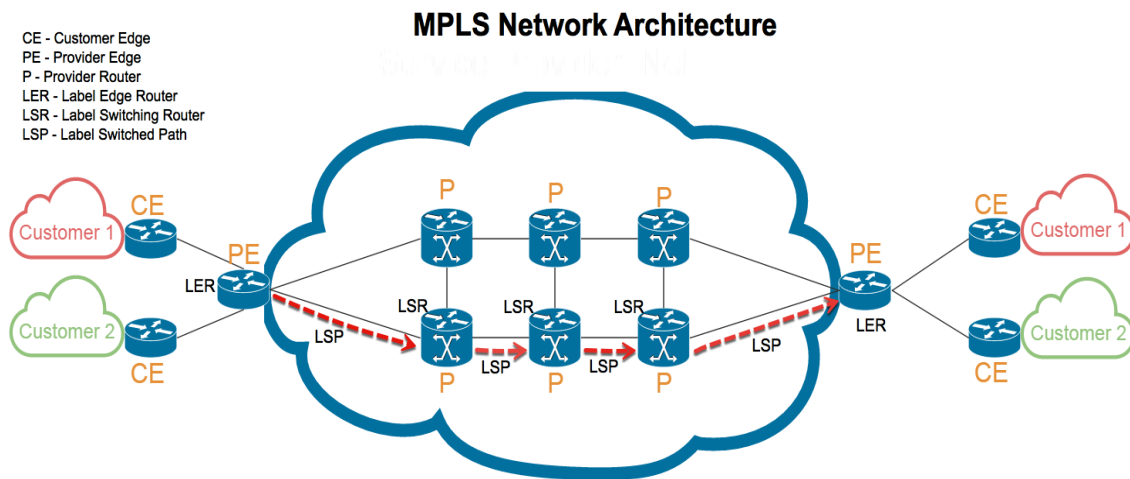

Figure 1: MPLS Architecture

Label Switched Path (LSP):

The packet is forwarded based on the information in the MPLS header and the interface that the packet arrived on, which is used as an index in table lookups. There are three basic types of operations that can be applied to IP packet such as Push the label stack, Swap the top label with a new label and Pop the label stack.

When various Layer 3 packets are entering the Ingress LSR, they are classified into a FEC. Once the packets are classified, they are forward to respective LSP for this FEC. An LSP may carry more than one FEC.

When an IP packet traverses through a MPLS domain, it follows a predetermined path depending on the FEC to which it was assigned by the ingress LER. The path the packet follows through the MPLS domain is called the Label Switched Path (LSP). LSPs are unidirectional so to build a duplex communication two LSPs are needed.

Forwarding Equivalence Class (FEC):

The traffic flows that are aggregated in MPLS are called an FEC. In MPLS network, all IP packets that are forwarded over the same path and treated in the same manner belong to the

same FEC. There should be a FEC to assign any unlabeled incoming packet into a group that will become MPLS labeled packets. MPLS FEC membership is not strictly based on shortest path first (SPF) destination address calculations as in IP, but can be determined based on other parameters such as packet source, DiffServ code points (DSCP) and some QoS parameters found in the network, transport and application headers. If suppose classification is based on the five-tuples (source and destination IP addresses, source and destination Transmission Control Protocol (TCP) or User Datagram Protocol (UDP) ports, and a protocol number). This results in fine-granularity FECs. If the classification is based just on the destination IP address, then the resulting FECs are of medium-granularity. If the FEC classification is based solely on the egress LSR, this creates coarse-granularity FECs.

MPLS Header:

This MPLS header is 32 bits long and is often called the "shim" header. Forwarding in MPLS is done by using the label in the MPLS header. Therefore the MPLS header has to be inserted into packages that are to be routed in the MPLS domain. For data link layer switching technologies like ATM and FR, the MPLS header is inserted in the native label field for that protocol. In the case where the Layer 2 technology does not support a native label field, the MPLS header must be inserted between the Layer 2 and Layer 3 headers.

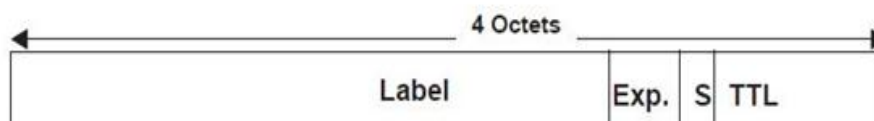

- Label: Label Value, 20
- Exp.: Experimental, 3 bits (was Class of Service)
- S: Bottom of Stack, 1 bit (1 = last entry in label stack)
- TTL: Time to Live, 8 bits

Figure 2: MPLS Header

Signaling Protocols in MPLS:

In an MPLS network, the type of information exchanged between routers depends on the signaling protocol being used. Signaling is a way in which routers exchange relevant information. At a base level, labels must be distributed to all MPLS enabled routers that are expected to forward data for a specific FEC and LSPs created. The MPLS architecture does not assume any single signaling protocol and four methods have been specified for label distribution.

A. Resource Reservation Protocol extension for MPLS (RSVP-TE)

B. Constrained Routing with LDP (CR-LDP)

C. Label Distribution Protocol (LDP)

A. Distributing labels with Border Gateway Protocol (BGP):

BGP is a routing protocol used between different autonomous systems to exchange routing information. The Border Gateway Protocol (BGP) can also be used for label distribution. The update messages in BGP that are used to distribute BGP routes can additionally carry the appropriate MPLS labels that are mapped to the same BGP route. The label mapping information for a particular route is piggybacked in the same BGP update message that is used to distribute the route itself.

B. Constrained Routing with LDP (CR-LDP):

The term constraint implies that for each set of nodes there exists a set of constraint that must be satisfied for the link or links between two nodes to be chosen for an LSP. CR-LDP is an extension of LDP to support constraint based routed LSPs. An example of a constraint is to find a path that needs a specific amount of bandwidth. LSRs that use CR-LDP to exchange label and FEC mapping information are called LDP peers; they exchange this information by forming a LDP session. There are four categories of LDP messages:

1. Discovery messages announce and maintain the presence of an LSR in an MPLS domain. This message is periodically sent as a Hello message through a UDP port with the multicast address of all routers on this subnet.
2. Session message is sent to establish, maintain and delete sessions between LDP peers.
3. Advertisement messages create, change and delete label mappings for FECs.
4. Notification Messages provides status, diagnostic and error information.

The last three message types are transported over TCP. CR-LDP makes hard state reservations which means that reserved resources has to be removed explicitly.

D. Label Distribution Protocol (LDP)

The motivation behind setting up an LSP that follows the same path as conventional IP instead of just using conventional IP routing was originally to speed up the forwarding in routers. In conventional IP routing the next hop for each packet is found by a longest match prefix lookup on the IP header in the routing table. LDP is designed for the purpose of distributing MPLS labels, LDP works like "hop-by-hop" forwarding. It always selects the same physical path that conventional IP routing would select. Thus LDP does not support Traffic Engineering (TE). These lookup could in some cases where the routing tables were large be time consuming and it was thought that data forwarding with label switching instead of IP lookups would speed up data forwarding. Because of the recent development in routing technology, LDP is not much used for label distribution today. There is however an extension to the original LDP protocol that brings new functionality for the LDP protocol called CR-LDP.

Reservation Styles: Each LSP can be reserved with a specific reservation style. There are three types of reservation styles as

1. Shared Explicit (SE): Allows a receiver to explicitly specify the senders to be included in a reservation. There is a single reservation on a link for all the senders listed. Because each sender is explicitly listed in the RESV message, different labels may be assigned to different senders, thereby creating separate LSPs.

2. Fixed Filter (FF): In fixed filter a distinct reservation is made for traffic from each sender. This reservation cannot be shared by other senders.

3. Wildcard Filter (WF): With the Wildcard Filter (WF) reservation style, a single shared reservation is used for all senders to a session. The total reservation on a link remains the same regardless of the number of senders. A single multipoint-to-point label switched path is created for all senders to the session. On links that senders to the session share, a single label value is allocated to the session. If there is only one sender, the LSP looks like a normal point-to-point connection. When multiple senders are present, a multipoint-to-point LSP (a reversed tree) is created.

RELATED WORK:

In paper [1], depicts that for protecting a link failures use a MPLS Fast Re-route (FRR) mechanism. In path based restoration approach, if single link failure occur then there need to re-route entire flow in the network. While in link based or local approach, backup path created for each link and if link failed then this link based restoration only replace this failed link with backup path without changing the rest of the route. For distributing state information or routing use some routing

protocol such as Open Shortest Path First (OSPF) and also reconfiguring backup paths use some distributed algorithm.

In paper [2], depicts that FRR mechanism is beneficial over a link based or local based restoration. This is based on holistic view of network performance that is selecting the LSP which is less congested or less traffic available on that LSP. This FRR protection is special case of p-cycle scheme because p-cycle scheme is a set of cycles are defined over the whole network such that each link is either on-cycle link or a straddling link Hamiltonian p-cycle created for whole network for used to protect all links.

This scheme uses backup paths along a set of pre-configured p-cycles that can be selected using design methodologies that consider the overall network performance. The benefits of the hybrid scheme increase with the density of the network; hence adopting a p-cycle design is an attractive alternative for MPLS network operators.

In paper [3], depicts that several techniques which are based on the IPFRR framework. These techniques mainly focus on repairing paths rather than mechanisms for fast failure detection. We propose a routing technique, recursive Loop-Free Alternates (rLFAs), to alleviate packet loss due to transient link failures. The technique consist a backup path calculation for re-routing scheme based on the Loop-Free Condition (LFC) based on IP Fast Re-Route (IPFRR). For this routing strategy, nodes calculate backup paths by modifying the weights of links in the primary shortest path tree. The detecting node determines the number of recursions, which indicates the number of times packets must be forwarded along the alternate next hops to bypass the failed link. Several approaches based on IP Fast Re-Route (IPFRR) in which alternate paths are pre-computed for fast re-route in presence of failures, have been proposed to alleviate (reduce) packet loss rate due to failures. The main objective of fast re-route is to prevent packets from being dropped due to failures.



Figure 3: Comparison of Link Protection

In paper [4], depicts that Primary and backup paths in MPLS fast reroute (FRR) may be established as shortest paths according to the administrative link costs of the IP control plane, or as explicitly calculated arbitrary paths. The main objective is the maximum link utilization for a set of considered failure scenarios is minimized. For that load balancing mechanism useful to distribute traffic among the free or less congested link or LSP this will reduces the packet loss occur due to link failures in the network. Here also explain a mechanism such as MPLS fast reroute (MPLS-FRR) which is one to one backup path for each failed link. It is a local backup mechanism, i.e., the routers adjacent to a failure act as so it is called points of local

repair (PLRs) and redirect packets over alternative local backup LSPs to the destination.

From this comparison shows that multiple explicit primary and backup paths allow lower maximum link utilization than unique explicit paths and unique primary and backup paths satisfying IP routing constraints may lead to higher maximum link utilization that is the use of explicit path layouts may increase the number of backup paths. Thus, a considerable improvement of the resource efficiency usage in protected MPLS networks as compared to the simple setup of primary and backup paths with the IP control plane can be obtained for the price of increased control plane complexity required for establishing optimized explicit paths and load balancing.

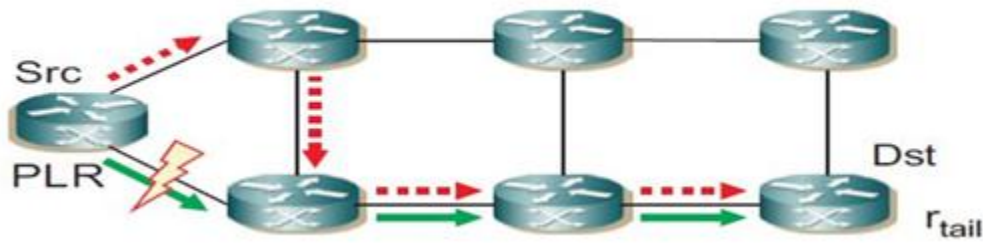

Figure 4: Link Detour after Failure

In paper [5], depicts that Fast-reroute mechanism especially for establishing backup path while link failures, but it is not effective for multiple failures frequently occurring in backbone networks. Backbone network, router-to-router links carry the traffic of multiple end-to-end connections. If link failure occurs then all the connections traversing it that failure link also fails. the main focus is on recovering end-to-end connections using path protection techniques. In link protection using MPLS fast reroute is to pre-compute alternate paths to handle dual-link failures, they are more complex. Because a first link failure may affect the backup path of a other link, the pre-

computed backup paths for each link would have to consider all possible combinations of failures of other links. Here uses OSPF-TE and RSVP and is a natural extension to the MPLS fast-reroute. The main focus is that each node running a simple reconfiguration algorithm independently. Further we can deal with multiple concurrent failures in a scalable and adaptive manner by exploiting the capability of Layer 3 protocols (OSPF) to disseminate (i.e. spread information) the backup path information for a failed link, so as to reconfigure other backup paths.

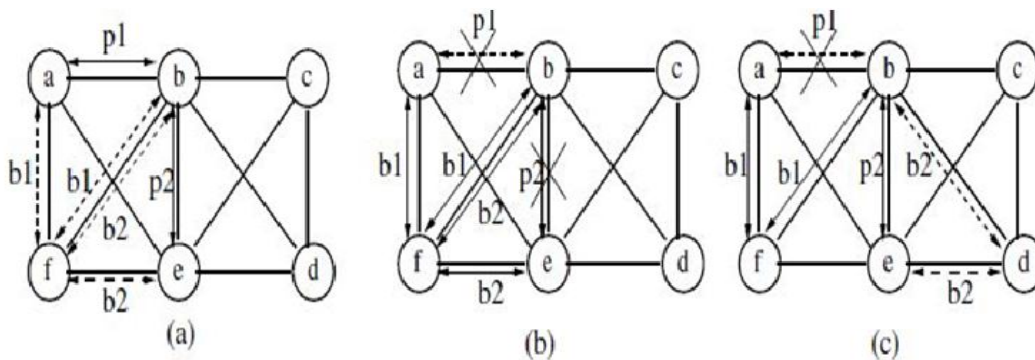

Figure 5: Backup path Reconfiguration

In [6] depict that fast rerouting has been a key component for providing service continuity to end users. These RFR mechanisms are able to significantly reduce average delay due to path restoration while eliminating packet disorder for traffic in MPLS networks for a protected LSP. However, critical services or hard real time will be affected by packet losses and, for TCP traffic, lost packets trigger retransmission requests; hence the gains due to the decrease in restoration time may become negligible. The main factors that affect the performance of fast rerouting mechanisms are packet loss, traffic recovery delay i.e. Full Restoration Time and packet disorder. The RFR mechanism uses a novel recovery algorithm with small local buffers in each LSR node within the protected path

in order to eliminate both packet losses due to link failure and packet disorder during the restoration period.

In [7] depict that Multiprotocol Label Switching is an architecture developed to combine the dynamic nature of IP routing protocols and the efficiency of label switching. There is an issue in network such that it must support the real-time services or multimedia applications even in the presence of node or link failures. MPLS employs two basic techniques for network protection from such failures as first protection switching where a pre-computed alternative path is set up for every flow and second is rerouting where an alternative path is dynamically recomputed after a fault is detected. For both techniques, the alternative path can be either global or local.

The main focus is combine the protection-switching algorithm with the rerouting algorithm and the choice of the algorithm is based on the performance criteria such as Fault recovery time, Packet loss, Packet reordering and Multiple faults. The challenge is to find an efficient way to combine the two algorithms in order to obtain a third one that would perform well in all four these criteria.

In [8] depict that Multiprotocol Label Switching (MPLS) technology enables configuration of end-to-end virtual connections in communication networks, especially in networks without connection-oriented capabilities. Labeled packets can be sent over the connections and forwarded according to the labels over called as Label Switched Paths (LSPs). MPLS is able to detect network failures locally and thus a failure-detecting router can quickly switch all packets from failing primary LSP path to a backup LSP path just after a failure is detected. This is called fast reroute (FRR) capability and the failure-detecting router is the called point of local repair (PLR).

This paper focuses on compact node-link formulations for MPLS fast reroute optimal single path layout. Also proposes mathematical formulations for MPLS fast reroute local protection mechanisms. The comparison one-to-one (called detour) local protection and many-to-one (backup) local protection mechanisms with respect to minimized maximum link utilization.

In [9] depict that the author consider the two recovery possibilities for the alternative or backup LSP such as pre-established and dynamic recovery i.e. rerouting. The objective is to provide a path protection mechanism in MPLS networks. The Haskin's proposal scheme uses a fault notification mechanism (FIS) to send the information about the occurrence of a fault to a responsible node in order to take the appropriate action to that failure such as in ingress LSR is notified to switch traffic from the protected path to the alternative path. The Haskin's proposes method based on FRR mechanism and rerouting mechanism i.e. dynamic routing. This mechanism uses FRR with reversing backup for link failure environment in MPLS network. This mechanism beneficial for reducing the packet loss and but there is need for packet reordering. It is totally based on the FRR mechanism in that it uses local mechanism for it path recovery when there is link failure.

In [10] depict that the authors consider the two recovery possibilities for the alternative LSP such as pre-established or FRR mechanism and dynamic recovery or rerouting. The objective is to provide a path protection mechanism in MPLS networks. This scheme uses a fault notification mechanism (FIS) to convey information about the occurrence of a fault to a responsible node in order to take the any action against the link failure. In the case of using the pre-established

alternative LSP or backup path, the traffic entering the domain is directly diverted to the pre-established alternative LSP by the ingress LSR after the arrival of the notification signal.

This method provides better resource utilization in than network than Haskin's scheme because the length of the protection path used during the recovery period is less than that of Haskin's proposal. However, the traffic that is in transit during the interval of time between the detection of the fault detected and the time the fault notification signal reaches the ingress LSR will be dropped by the alert LSR. Moreover, those packets that were circulating on the failed link at the time of the failure will also be lost. When the dynamic method is applied, as it takes much longer to establish the alternative LSP, and the amount of dropped packets is larger than with the pre-established alternative LSP or backup path. Resource utilization is more efficient than other scheme because updated network information is used. This scheme also provides more flexibility in the establishment of a new alternative LSP or backup path.

CONCLUSION:

As per the survey, MPLS based on some performance parameters. The parameters consider for analysis such as fault recovery time, packet loss ratio, resource requirement complexity, packet re-ordering, optimal path option selection. The analysis can be done through any simulation tool such as Network Simulator version 2 (NS2), NS3 etc

REFERENCES:

- path MPLS Fast Reroute layout*", *ADVANCES IN ELECTRONICS AND TELECOMMUNICATIONS, VOL. 2, NO. 3, SEPTEMBER 2011.*
1. Rakesh K. Sinha, Funda Ergun, Kostas N. Oikonomou, K. Ramakrishnan, "Network Design for Tolerating Multiple Link Failures Using Fast Re-Route (FRR)", *IEEE*, 2014.
 2. Chang Cao, George N. Rouskas, "Hybrid FRR/p-Cycle MPLS Link Protection Design", *IEEE Communications Society subject matter experts for publication in the IEEE Globecom*, 2011.
 3. Suksant SaeLor, Redouane Ali, Raul Landa, and Miguel Rio, "Recursive Loop- Free Alternates for Full Protection Against Transient Link Failures", *IEEE*, 2010.
 4. Micha Piro, Artur Tomaszewski, Cezary Zukowski, David Hock, Matthias Hartman, Michael Menth, "Optimized IP-Based vs. Explicit Paths for One-to-One Backup in MPLS Fast Reroute", *IEEE, 14th International Telecommunications Network Strategy and Planning Symposium (NETWORKS 2010), Warsaw, Poland, sept 2010.*

5. Ajay Todimala, K. K. Ramakrishnan and Rakesh K. Sinha, "Cross-layer Reconfiguration for Surviving Multiple-link Failures in Backbone Networks", *IEEE*, 2009.
6. Lemma Hundessa and Jordi Domingo-Pascual, "Reliable and Fast Rerouting Mechanism for a Protected Label Switched Path", *Departament d'Arquitectura de Computadors Universitat Politècnica de Catalunya (UPC) C/Jordi Girona 1-3, 08034. Barcelona, Spain*.
7. Maria Hadjiona, Chryssis Georgiou and Vasos Vassiliou, "A Hybrid Fault-Tolerant Algorithm for MPLS Networks", *Department of Computer Science University of Cyprus*.
8. Cezary Żukowski, Artur Tomaszewski, Michał Pióro, David Hock, Matthias Hartmann and Michael Mentz, "Compact node-link formulations for the optimal single path MPLS Fast Reroute layout", *ADVANCES IN ELECTRONICS AND TELECOMMUNICATIONS, VOL. 2, NO. 3, SEPTEMBER 2011*.
9. D. Haskin and R. Krishnan, "A Method for Setting an Alternative Label Switched Paths to Handle Fast Reroute", *Work in progress, Internet draft <draft-haskin-mpls-fast-reroute-05.txt>, November 2000*.
10. S. Makam, V. Sharma, K. Owens, and C. Huang, *Protection/Restoration of MPLS Networks. Work in progress, Internet draft <draft-makam-Mpls protection-00.txt>, October 1999*.
11. Lemma Hundessa Gonfa, "ENHANCED FAST REROUTING MECHANISMS FOR PROTECTED TRAFFIC IN MPLS NETWORKS", *UPC. Universitat Politècnica de Catalunya, 2011*.
12. Johan Martin Olof Petersson, "MPLS Based Recovery Mechanisms", *Master Thesis, 2005*.
13. Rozita Yunus, Siti Arpah Ahmad, Noorhayati Mohamed Noor, Raihana Md Saidi, Zarina Zaino, "Analysis of Routing Protocols of VoIP VPN over MPLS Network", *2013 IEEE Conference on Systems, Process & Control (ICSPC2013), 13 - 15 December 2013*.
14. Md. Arifur Rahman, Ahmedul Haque Kabir, K. A. M. Lutfullah, M. Zahedul Hassan, M. R. Amin, "Performance Analysis and the Study of the behavior of MPLS Protocols", *Proceedings of the International Conference on Computer and Communication Engineering 2008*.
15. http://www.cisco.com/c/en/us/td/docs/ios/12_0s/feature/guide/gslnh29.html.

National Conference on Current Trends in Engineering, Science and Technology
(NACCTEST- 2018) Organized by GF's Godavari College of Engineering, Jalgaon
International Journal of Innovations in Engineering and Science, Special Conference Issue,
2018

www.ijies.net

BLOCKCHAIN TECHNOLOGY- A SURVEY

Poonam P Patil

M.Tech. Student Department of Computer Engineering

Mr. Rahul Gaikwad

gaikwad005@gmail.com

Asst. Professor Department of Computer Engineering

GF's Godavari College of Engineering

Jalgaon -425003, Maharashtra, India

Abstract – Blockchain is being termed as the fifth disruptive innovation in computing. In simplest words, it is a distributed ledger of records that is immutable and verifiable. Since its advent in 2008, blockchain as a concept has been used in various ways. The largest impact or application is seen as a multitude of cryptocurrencies that have sprung up. However, with time, it has become clear that blockchain as a technology is likely to have an impact much wider than just the cryptocurrency domain and much deeper than simple distributed ledger storage. This detailed survey intends to bring together all the key developments so far in terms of putting blockchain to practice. While the most common adoption of blockchain is in finance and banking domain, there are experiments being conducted by many big players in various other domains. This paper will explore the various domains where blockchain has had an impact and where future implementations may be expected.

General Terms-Blockchain

Keywords-Blockchain, Cryptocurrency, Distributed Ledger

INTRODUCTION

Blockchain technology or the distributed, secure ledger technology has gained much attention in recent years. This paper presents a detailed survey of blockchain technology literature and its applications. The sources of blockchain literature examined for this survey include research papers, books and book chapters, journal papers, specific cryptocurrency sites and wikis, conference papers, company 'Point of View's (PoVs), whitepapers published by various organizations implementing and experimenting in Blockchain. Blockchain being a much hyped and experimented technology a lot of literature is found in content hosted on proprietary forums such as company websites, web articles, etc. This survey is extensive and covers the various aspects of blockchain including

consensus algorithms and their variations as well as currently implemented and possible future applications. This survey will not cover the details of technical aspects of blockchain, however, references that cover these aspects may be found in bibliography.

BLOCKCHAIN OVERVIEW

- **Blockchain Technology**

The blockchain is the core mechanism for the Bitcoin. Blockchain was first proposed in 2008 and implemented in 2009. Blockchain can be regarded as a public ledger, in which all committed transactions are stored in a chain of blocks. This chain continuously grows when new blocks are appended to it. The blockchain technology has the key characteristics, such as decentralization, persistency, anonymity and auditability. Blockchain can work in a decentralized environment, which is enabled by integrating several core technologies such as cryptographic hash, digital signature (based on asymmetric cryptography) and distributed consensus mechanism. With blockchain technology, a transaction can take place in a decentralized fashion. As a result, blockchain can greatly save the cost and improve the efficiency.

Although Bitcoin is one of the most famous blockchain applications, blockchain can be applied into diverse applications far beyond cryptocurrencies. Since it allows payment to be finished without any bank or any intermediary, blockchain can be used in various financial services such as digital assets, remittance and online payment.

BLOCKCHAIN ARCHITECTURE

Blockchain is a sequence of blocks, which holds a complete list of transaction records like conventional public ledger. Figure 1 illustrates an example of a blockchain. Each block points to the immediately

National Conference on Current Trends in Engineering, Science and Technology (NACCTEST- 2018) Organized by GF's Godavari College of Engineering, Jalgaon
International Journal of Innovations in Engineering and Science, Special Conference Issue, 2018

www.ijies.net

previous block via a reference that is essentially a hash value of the previous block called parent block.

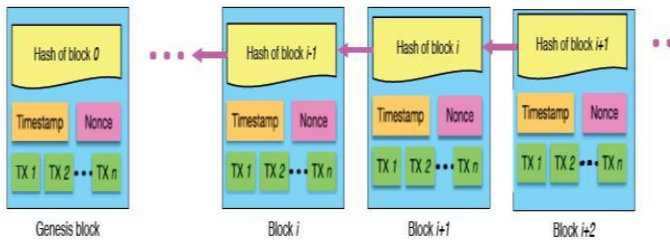

Fig1: An example of blockchain which consist of a continuous sequence of block

It is worth noting that uncle blocks (children of the block’s ancestors) hashes will also be stored in ethereum blockchain. The first block of a blockchain is called genesis block which has no parent block.

• **BLOCK**

A block consists of the block header and the block body as shown in Figure 2. In particular, the block header includes:

- (i) Block version: indicates which set of block validation rules to follow.
- (ii) Parent block hash: a 256-bit hash value that points to the previous block.
- (iii) Merkle tree root hash: the hash value of all the transactions in the block.
- (iv) Timestamp: current timestamp as seconds since 1970-01-01T00:00 UTC.
- (v) nBits: current hashing target in compact format.
- (vi) Nonce: an 4-byte field, which usually starts with 0 and increases for every hash calculation

The block body is composed of a transaction counter and transactions. The maximum number of transactions that a block can contain depends on the block size and the size of each transaction. Blockchain uses an asymmetric cryptography mechanism to validate the authentication of transactions. Digital signature based on asymmetric cryptography is used in an untrustworthy environment

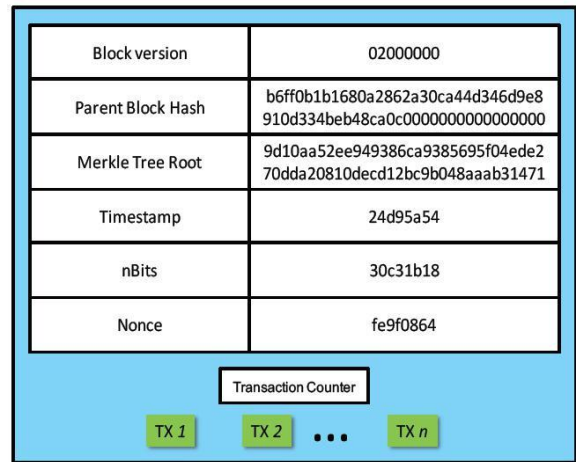

Fig 2: Block structure

• **DIGITAL SIGNATURE**

Each user owns a pair of private key and public key. The private key is used to sign the transactions. The digital signed transactions are spread throughout the whole network and then are accessed by public keys, which are visible to everyone in the network. Figure 3 shows an example of digital signature used in blockchain.

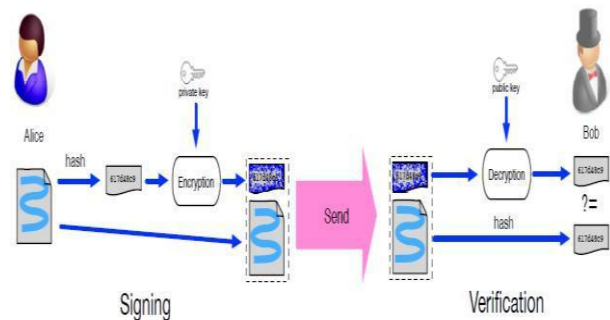

Fig 3: Digital Signature used in blockchain

The typical digital signature is involved with two phases: the signing phase and the verification phase.

KEY CHARACTERISTICS OF BLOCKCHAIN

In summary, blockchain has following key characteristics.

- **Decentralization.** In conventional centralized transaction systems each transaction needs to be validated through the central trusted agency (e.g., the central bank) inevitably resulting the cost and the performance bottlenecks at the central servers.

National Conference on Current Trends in Engineering, Science and Technology
(NACCTEST- 2018) Organized by GF’s Godavari College of Engineering, Jalgaon
International Journal of Innovations in Engineering and Science, Special Conference Issue, 2018

www.ijies.net

• **Differently**, a transaction in the blockchain network can be conducted between any two peers (P2P) without the authentication by the central agency. In this manner, blockchain can significantly reduce the server costs (including the development cost and the operation cost) and mitigate the performance bottlenecks at the central server.

• **Persistency**. Since each of the transactions spreading across the network needs to be confirmed and recorded in blocks distributed in the whole network, it is nearly impossible to tamper. Additionally, each broadcasted block will be validated by other nodes and transactions will be checked. So any falsification will be detected easily.

• **Anonymity**. Each user can interact with the blockchain network with a generated address. Further, an user will generate many addresses to avoid identity exposure. There is no longer any central party keeping users’ private information.

• **Auditability**. Since each of the transactions on the blockchain is validated and recorded with a timestamp, users can easily verify and trace the previous records through accessing any node in the distributed network. In Bitcoin blockchain, each transaction can be traced to previous transactions iteratively. It improves the traceability and the transparency of the data stored in the blockchain.

TAXONOMY OF BLOCKCHAIN SYSTEMS

Current blockchain systems can be roughly categorized into three types: public blockchain, private blockchain and consortium blockchain. We compare these three types of blockchain from different perspectives. The comparison is listed in Table 1.

Table 1 Comparisons among public blockchain, consortium blockchain and private blockchain

Property	Public blockchain	Consortium blockchain	Private blockchain
Consensus determination	All miners	Selected set of nodes	One organization
Read	Public	Could be public or	Could be public or

permission		restricted	Restricted
Immutability	Nearly impossible to tamper	Could be tampered	Could be tampered
Efficiency	Low	High	High
Centralized	No	Partial	Yes
Consensus process	Permissionless	Permissioned	Permissioned

• **Consensus determination**. In public blockchain, each node can take part in the consensus process. And only a selected set of nodes are responsible for validating the block in consortium blockchain. As for private chain, it is fully controlled by one organization who can determine the final consensus.

• **Read permission**. Transactions in a public blockchain are visible to the public while the read permission depends on a private blockchain or a consortium blockchain. The consortium or the organization can decide whether the stored information is public or restricted.

• **Immutability**. Since transactions are stored in different nodes in the distributed network, so it is nearly impossible to tamper the public blockchain. However, if the majority of the consortium or the dominant organization wants to tamper the blockchain, the consortium blockchain or private blockchain can be reversed or tampered.

• **Efficiency**. It takes plenty of time to propagate transactions and blocks as there are a large number of nodes on public blockchain network. Taking network safety into consideration, restrictions on public blockchain will be much more strict. As a result, transaction throughput is limited and the latency is high. With fewer validators, consortium blockchain and private blockchain can be more efficient.

• **Centralized**. The main difference among the three types of blockchains is that public blockchain is decentralized, consortium blockchain is partially centralized and private blockchain is fully centralized as it is controlled by a single group.

National Conference on Current Trends in Engineering, Science and Technology
(NACCTEST- 2018) Organized by GF's Godavari College of Engineering, Jalgaon
*International Journal of Innovations in Engineering and Science, Special Conference Issue,
2018*

www.ijies.net

• **Consensus process.** Everyone in the world can join the consensus process of the public blockchain. Different from public blockchain, both consortium blockchain and private blockchain are permissioned. One node needs to be certificated to join the consensus process in consortium or private blockchain.

APPLICATIONS OF BLOCKCHAIN

There is a diverse of applications of blockchain technology. In this section, we summarize several typical applications of blockchain.

• **Social Inclusion**

As internet has become an accessible global platform to bring the world together, thanks to the mobility revolution, it is possible for the people in remotest parts of the world to access internet resources across the world. Cryptocurrencies enable people with no access to physical banks to perform global transactions with others across the world

• **Cryptocurrency**

Currency that is in use across the world is largely fiat currency or currency whose value is assured by a government guarantee, e.g. Indian Rupees, US Dollar, Great Britain Pound, etc. These currencies are not backed by physical assets. Commodity money is backed by a tradable resource, like Gold and Silver. Its value is at least as much as the value of the commodity itself.

• **Reputation Management**

A successful implementation of reputation management can be found in Accenture's [8] Akshay Patra Midday Meal Program Management project. This project used a private blockchain implementation to gather real time, direct feedback from schools that is not manipulated by intermediaries. Thus blockchain has provided the required transparency to the meal chain, to help in audits and invoicing.

• **Education**

Blockchain can be the transformational force in education as well. Sharples and Domingue [17] have suggested the use of blockchain to provide a verifiable, easily shareable and permanent record of such educational records and rewards. It also talks about the

possibility of having an 'Educational Reputation Currency', which is initially distributed to participating institutes based on any existing metric.

• **Banking**

The impact of blockchain as a technology was first felt by the banking and trading sector. So much so that Bitcoin and its underlying technology, the blockchain, were initially seen as the biggest threat to banking businesses worldwide. However, in past few years it has been seen that banks have deep dived to make this technology work for them in a favorable manner and are experimenting various ways to use blockchain in their business.

• **Finance – Payroll and Settlement**

Public service transactions may be as trivial as buying a train ticket or more complex ones such as marriage registration, property buy and sell, patent management, etc. Typically public service transactions require a series of actions to validate the authenticity of the transacting party (or parties), verification of the data provided by the transacting party (or parties), conduct the required transaction and finally provision of the required service followed by recording of the end to end transaction. This translates into significant turnaround time for the transacting parties..

BLOCKCHAIN PROTOCOLS

Blockchain eliminates the need for third party to conduct transactions on one's behalf. This implies that the consensus mechanism has to exist in the network itself. How a given blockchain network implements its consensus mechanism, determines the strength of the network. A foolproof consensus mechanism, suitable for purpose (of the blockchain in question) is essential to maintain sanity and coherence of data among the participating nodes of the network.

• **Proof of Work**

PoW protocol requires all nodes on the network to solve cryptographic puzzles by brute force. For example, in case of Bitcoin blockchain, the new transactions are tentatively committed and then based on the PoW output, a selected block created by the winning node is broadcast to all the nodes, at specific synchronization intervals.

National Conference on Current Trends in Engineering, Science and Technology
(NACCTEST- 2018) Organized by GF's Godavari College of Engineering, Jalgaon
International Journal of Innovations in Engineering and Science, Special Conference Issue, 2018

www.ijies.net

- **Proof of Stake**

Proof of stake protocol of block verification does not rely on excessive computations. It has been implemented for Ethereum and certain altcoins. Instead of splitting blocks across proportionally to the relative hash rates of miners (i.e. their mining power), proof-of-stake protocols split stake blocks proportionally to the current wealth of miners. The idea behind Proof of Stake is that it may be more difficult for miners to acquire sufficiently large amount of digital currency than to acquire sufficiently powerful computing equipment. It is also an energy saving alternative [1, 11].

- **Practical Byzantine Fault Tolerance**

An approach to deal with the Byzantine Generals problem is the Federated Byzantine Agreement (FBA). In this approach, it is assumed that the participants of the network know each other and can distinguish which ones are important and which ones are not. PBFT (Practical byzantine fault tolerance) is a replication algorithm which utilizes this principle. The primary is responsible for multicasting requests to other replicas in its group.

- **Blockchain Consensus Algorithms**

1. Proof of Work

E.g.: Bitcoin, Litecoin, Dogecoin, Namecoin

Pros:

- Considered very secure, as less prone to Sybil attack unless a mining node acquires
- 51% of the pools computing power.
- Miners get rewards (as Bitcoins)
- Prevents unlawful forking of the chain

Cons:

- Quite slow at the moment, only 1 block added in 10 mins
- Driven by rewards assigned to solving the hash, may run into problems as rewards dwindle
- Consumes lot of electricity (mining likely to be centralized where electricity is cheap!)

- Decisions are not final till 6 blocks are confirmed

2. Proof of Stake

E.g.: Nxt, Mintcoin

Pros:

- Less wasteful in terms of energy consumption
- Less chance of hardware centralization
- Potentially faster than Proof-of-work protocol
- Possibly reduced possibility of selfish mining attack (assuming already rich miners are less likely to attack!)

Cons:

- Miners are encouraged to hold on to their stake rather than converting it into at currency
- Economic penalties for fraudulent attempts

3. Practical Byzantine Fault Tolerance

E.g.: Stellar, Ripple

Pros: • Can tolerate 1/3rd of the nodes to be faulty or adversarial

- Fast and efficient
- Trust is decoupled from resource ownership, so small group can keep a powerful organization in check

Cons: • Parties must agree to the exact participation of groups

- Comes at the cost of anonymity

OTHER RELATED WORK

Blockchain has its inherent challenges and limitations. Due to peer to peer network operation, it is high on energy usage and hence wastage per unit computation. While all the network nodes compete to add the block in case of a Proof of Work based blockchain system, only one node succeeds in adding its transactions block each time. As a result, while other blocks contributed to transaction validation and verification process, thus reinforcing it, their efforts are effectively are wasted when the given transaction block is not added.

National Conference on Current Trends in Engineering, Science and Technology
(NACCTEST- 2018) Organized by GF's Godavari College of Engineering, Jalgaon
*International Journal of Innovations in Engineering and Science, Special Conference Issue,
2018*

www.ijies.net

CONCLUSION

In a plethora of blockchain based applications and experiments, faith on the longevity of blockchain technology, is increasing. Scalability and consensus algorithms are areas of growing research in order to make blockchain more adaptable for businesses of larger scale. Areas like taxation, education, insurance are yet to see a major overhaul via blockchain adoption and these can be the focus areas of future research in blockchain. Acceptance of cryptocurrency by governments and establishment of regulations governing them are very important to ensure ethical use of cryptocurrency. The public blockchains also provide an opportunity of mining interesting patterns of cryptocurrency usage, user behaviors and monetary networks across the globe.

REFERENCES

- [1] Pilkington Mark. 2016 *Blockchain Technology: Principles and Applications, Research Handbook on Digital Transformations, Social Science Research Network*
- [2] Swan Melanie. 2015. *Blockchain: Blueprint for a new Economy*, O'Reilly Publications
- [3] Peters G.W. Panayi E. 2016. *Understanding Modern Banking Ledgers Through Blockchain Technologies: Future of Transaction Processing and Smart Contracts on the Internet of Money*, Banking Beyond Banks and Money, Springer Sep 2016, pp. 239-278
- [4] Satoshi Nakamoto. 2008, *Bitcoin: A Peer-to-Peer Electronic Cash System*, [Online] <http://www.bitcoin.org>
- [5] Buterin, Vitalik. 2015, *On Public and Private Blockchains*. [Online] <https://blog.ethereum.org/2015/08/07/on-public-and-private-blockchains/>
- [6] Xu et al. 2017. *A Taxonomy of Blockchain-Based Systems for Architecture Design*. 2017 IEEE International Conference on Software Architecture (ICSA), Gothenburg, Sweden, 3-7 April 2017
- [7] Huaiqing Wang, Kun Chen and Dongming Xu. 2016. *A maturity model for blockchain adoption*. *Financial Innovation*, Springer, Open Access, DOI 10.1186/s40854-016-0031-z
- [8] Kiran Balasubramanian. 2017, *Accenture Labs and Akshaya Patra Use Disruptive Technologies to Enhance Efficiency in Mid-Day Meal Program for School Children*. *Accenture Newsroom*. [Online] <https://newsroom.accenture.com/news/accenture-labs-and-akshaya-patra-use-disruptive-technologies-to-enhance-efficiency-in-mid-day-meal-program-for-school-children.htm>
- [9] Cachin et al. 2017. *Blockchain, cryptography, and consensus*, IBM Research, Jun 2017, <https://www.itu.int/en/ITU-T/Workshops-and-Seminars/201703/Documents/Christian%20Cachin%20blockchain-itu.pdf>
- [10] Decker, Wattenhofer. 2013. *Information Propagation in the Bitcoin Network*, 2013 IEEE Thirteenth International Conference on Peer-to-Peer Computing (P2P). [Online] <http://dx.doi.org/10.1109/P2P.2013.6688704>
- [11] BitFury group. 2015. *Public versus Private Blockchains Part 1: Permissioned Blockchains*, BitFury.com whitepapers [Online]: <http://bitfury.com/content/5-white-papers-research/public-vs-private-pt1-1.pdf>
- [12] Crosby et.al. 2016. *BlockChain Technology: Beyond Bitcoin*, *Applied Innovation Review*, Issue No. 2 June 2016. [Online]. Available: <http://scet.berkeley.edu/wp-content/uploads/AIR-2016-Blockchain.pdf>
- [13] Edgeverve-Infosys team. 2017. *Blockchain Technology From Hype to Reality: Edgeverve Infosys Finacle Report*, Feb 2017. [Online]. Available: https://www.edgeverve.com/wp-content/uploads/2017/02/Blockchain_Technology_From_Hype_to_Reality_Infosys_Finacle.pdf
- [14] Trevor Kiviat. 2015. *Beyond Bitcoin: Issues in Regulating Blockchain Transactions*, HeinOnline.org.
- [15] Cryptocurrency Market Capitalizations, [Online] <https://coinmarketcap.com/>
- [16] Zyskind et. al. 2015. *Decentralizing Privacy: Using Blockchain to Protect Personal Data*, 2015 IEEE Security and Privacy Workshops (SPW), San Jose, CA, USA, July 2015 [Online]. Available: <http://dx.doi.org/10.1109/SPW.2015.27>
- [17] Sharples M., Domingue J. 2016. *The Blockchain and Kudos: A Distributed System for Educational Record, Reputation and Reward*. In: Verbert K., Sharples M., Klobočar T. (eds) *Adaptive and Adaptable Learning*. EC-TEL 2016. *Lecture Notes in Computer Science*, vol 9891. Springer, Cham, [Online] Available: https://doi.org/10.1007/978-3-319-45153-4_48
- [18] Sony Global Education. 2016. *Sony Global Education Develops Technology Using Blockchain for Open Sharing of Academic Proficiency and Progress Records*, 22 February 2016. <http://www.sony.net/SonyInfo/News/Press/201602/16-0222E/index.html>
- [19] University of Nicosia. 2017. *Academic Certificates on the Blockchain*. <https://digitalcurrency.unic.ac.cy/free-introductory-mooc/self-verifiable-certificates-on-the-bitcoin-blockchain/academic-certificates-on-the-blockchain/>
- [20] Fanning, K et.al. 2016. *Blockchain and Its Coming Impact on Financial Services*, *The Journal of Corporate Accounting and Finance*, Wiley Periodicals, Inc. [Online]. <http://onlinelibrary.wiley.com/doi/10.1002/jcaf.22179/pdf>

CSE-14 Android Based Waste Food Management Using Sustainable Food Prevention Strategies

Ashwini Ahirrao¹, Shital Patil², Kanchan Mali³, Kajal Patil⁴, Priya Patil⁵, Ashfaque Shaikh⁶

^{1,2,3,4} Student

GF's Godavari COE Jalgaon (MS), India, 425001

⁵ Lecturer

patilpriya2012@gmail.com

GF's Godavari COE Jalgaon (MS), India, 425001

⁶ Assistant professor

sk.ashfaque.shaikh@gmail.com

GF's Godavari COE Jalgaon (MS), India, 425001

Abstract –The mobile devices are very vast in used in now a days android mobile in today's market come in very cheap rate and offerable for many people and now a days it become prime need for the people in many countries around the world face striving problem also in many situation like a family function or at restaurant there is lots of foods wastage happens. Here we playing to develop an app which will form a like between the striving and people those who have food waste in this project we communicate through the app and bridge the requirements of food donators and needy people through food wastage donation. The use of sustainable food prevention strategies which add some constraints to food testing in case of food making time is more. This project is used to manage wastage foods in a useful way. Every day the people are wasting lots of foods. So we have to reduce that food wastage problem through online. If anyone have wastage foods they are entering their food quantity details and their address in that application and then the admin maintain the details of food donator. The donator can create the account and whenever they are having wastage food they can login and give request to the admin. And the admin also maintain the needy People's details too and the admin collect foods from donator through their nearby agent then provide to nearest orphanages or poor people. After receiving the food from the agent by admin and give alert message to that donator. If the donator needs any detail about the orphanage with helping thought they can give request to the admin and collect the orphanage details. This paper is food redistribution is an

enormously successful social innovation that tackles food waste and food poverty. The user's details are maintained confidential because it maintains a separate account for each user.

1. INTRODUCTION

Now days many people around the world have wastage of food in their home and daily life, or in some programs and parties and other many so many situations are there where food is wasted. If anyone have extra food because of any function in their home it will become waste because instantly there is no way to share that food with anyone. Even if they want to give that extra food to any orphanage or poor people they don't have time or don't have an idea about that there for we came in this paper with idea of food wastage reduction. There are so many research papers available for wastage of food prevention but in this paper we deal with some food prevention strategies which will be used to secure food donation if food is fresh and have the quality to be donated to the needy people then it will donated otherwise it is donated to decomposition department. These strategies are imposed to increase safety and donating good quality food. The food redistribution is an enormously successful social innovation that tackles food waste and food poverty. We can add NGO's to the admin who will collect foods from donator through their nearby agent then provide to nearest orphanages or poor people. After receiving the food from the agent by admin and give alert message to that donator through this way we can reduce food wastage problem. Also we can have

direct food transmission to the needy people from donor this is because in the world nowhere all the NGO's will take part in this hence we can use direct donation techniques also. The work consist of few modules from registration to donation and receiving first users both donor and receiver have to register with the details then depends on the login criteria the users are redirected to their respective activities. Then the users are prompted for the details further we have three types of users donors, admins and receivers.

2. RELATED WORK

In this paper the authors focused on severe increase in the amount of food wastage, clothes, books, etc. this paper also focus on making the need for charity in terms of donation. This paper presents 'Helping Hands', a new internet-based application that provides a platform for donating old stuff and leftover food to all needy people/organizations. It provides information about the motivation to come up with such an application, thereby describing the existing donation system and how the proposed product works for the betterment of society. The product is shown to be an effective means of donating things to organizations, etc. over the internet. It shows the potential for avoiding the wastage of food, clothes, books and other stuff[1]

Smartphones are increasingly integrated with everyday uses. It utilize for various activities like e-commerce, social media, a messaging, a chart and map location application. A problem of waste food becomes a critical issue and it affect the social and environmental problem. Every time food is wastage the other sources water, energy, time, manpower, land, fertilizer, packaging and mainly money is also wasted. Food waste is big problem in India and it directly affect to the financial benefits. When huge quantity of food goes wasted instead of hungry mouths, it ends up in landfill means ultimately contributing to global warming by releasing methane gas. According to survey 40 percent of food is wasted from hotels and restaurant, marriage function, family function and household estimated that millions of rupees food is wasted every year in a country. Yet millions of people are hungry and in need of nourishment to overcome this problem we are proposing to new idea to facilitates the exchange in web based services here charity can easily find, secure and then deliver food to those who need it. This is the client-server GIS and Smartphone application for the hunger free city. At the client side App provide facility to donate food to the charity for the help of hungry people. Donors enter basic

information like quantity of waste food and type of waste along with latitude and longitude value and contact number. Charities can pick up that waste food and deliver food to hungers. Charities can mapped onto Google map with the help of GIS location based services using GIS coordinate (latitude and longitude) value. Completion of registration will placed onto server database where charities can store the entries of donor in table format and shows the optimal path between donor locations to nearest charity along with direction. So wastage food can easily deliver to hungry people within a time[2].

The need to address food security has never been greater and is moving up national agendas around the world. Achieving food security won't be easy considering the megatrends of growing population, greater affluence, and increasing urbanization. The global population is forecast to grow from the current 7 billion to 9 billion by 2050, creating the need for an increased food production of 70%. Recent investments in agricultural technology and advanced genetics have been making only a modest dent in meeting our global food demands.

Food is one of the most important drivers of environmental pressures, particularly in terms of water, land and resource use, greenhouse gas emissions (GHGs), pollution, and subsequent climate and habitat change. In terms of economic impacts, food waste represents high waste management costs and money wasted. Wasting food also raises social questions, particularly given the current global financial crisis, rising food prices and international food shortages. That's where waste prevention issue emerges. Even cutting waste in half would be a huge step toward global food security and a boon for the environment.

Food waste source prevention strategy focuses on preventing food waste before it is created.

Annakshetra is a unique initiative by Centre for Development Communication (CDC), Jaipur that connects the luxuries of the privileged ones with the sustenance issues of the other by collecting the surplus food left in the celebration gatherings like wedding / family occasion / festivities, then testing its edibility and feeding it to the underprivileged section of the society. The Annakshetra model based on 3Rs of waste prevention has been successful in minimizing food

Waste on one hand and feeding the needy on the other. The paper describes strategies and best practices of this model to implement sustainable food service, addresses the need to move towards Zero waste economy to ensure poverty eradication, food security and sustainable cities.

3. METHODOLOGY

The paper consist of few work modules from registration to donation and receiving first users both donor and receiver have to register with the details then depends on the login criteria the users are redirected to their respective activities. For session management we used the shared preferences technique. Then the users are prompted for the details further we have three types of users donors, admins and receivers. We have focused on the food prevention method authors in "Sustainable Food Waste Prevention Strategies to Achieve Food Security in India" discussed the sustainable food prevention techniques that can be applied to food to maintain the quality or to verify the quality of food. The word sustainable here is used to by means of transforming ways of living to increase the chances of ecofriendly conditions that will indefinitely support human safety, security, and healthiness. Generally, the flow of non-substitutable goods and facilities from this system must be sustained [3]. These are the factual ends of sustainability and there has been some recognition that their achievement, and their distribution, will be enhanced by decreasing the communication gaps between us

3.1. Food prevention techniques:

3.1.1 Food Security:

It contains three aspects: food availability, food access, and food use this facet consider the matching the large number of people's rapidly changing demand in this paper our main goal is to make food security in so that poorest persons will be no longer hungry by means of food access, availability and its use [3].

3.1.2 Reduce:

This facet indicate that if the food is efficiently reduced at the first phase then the food saved in a large part for the people and also its hurtful effects on the environment are prohibited. Reduce food means buying less quantities of any kind of processed or unprocessed food products that may end up into garbage [3].

3.1.3 Reuse:

It is the recovery point in this we collect the remaining food from sources and distributes among the hungry and needy. Thus value is obtained from leftover food of vast

significance which would otherwise have been wasted [3].

3.1.4 Recycle/Compost:

If the available food is not suitable for human consumption, it is sent for composting. For future scope we can also make a module of composition and provide the same to the needy and poor farmers. They can use it or recycle it using composition technique [3].

4. DESIGN

This application is developed on android studio 3.0.1 IDE with grade 4-1 and using languages java for coding and xml for designing it have google firebase database but there are different alternatives are also available like parse.com, MySQL etc. thus this application require internet connection as the android mobiles are very known to all people including poor's to rich. There are three types of users in this application we have, one is admin who will manage the operation and if require it can also form the bridge between user and receiver. To the admin we give pick and drop feature also hence we can add NGO's and Charity associations into the app as admin in case if someone going to publish this app worldwide. Therefore this app's admin levels are placed in future work. Second user is donor the one who have food leftover. They can register and make notification for food availability. The notification is shown to all the users and in notification the address of user is also shown by default and the also the scope to provide the address of place or location where the food is leftover and the contact number of donor as in case if they going to contact food donor. Before broadcasting the notification the app itself asks the donor about the type of food and its making time then this app will automatically add the sustainable food prevention facets by simple finding in the database for the time and type of food preservation if the food has passed the threshold limit then it is declared as fusty and notification is generated for composition not for the donation but as it is the future scope we have not included composition part in this app.

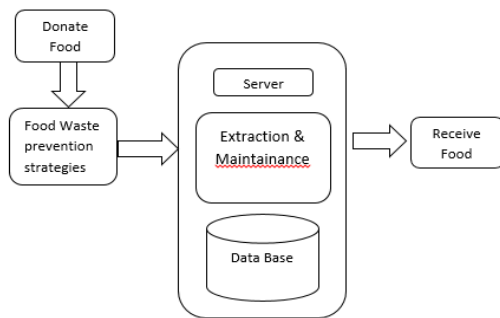

Fig. 1- Architecture of FoodsApp application

There are two major modules of the app donation and receiving we are forcing donor to specify the address where the food is available authors in references specified the location of food by using GIS based location[2] but it will be then difficult for the users who will make donate request from the distance where the food is located. Then after applying for donation of food the app will ask for the time and details of food. Like type of food, food type in smartphone based waste food supply chain is the breakfast, lunch, dinner etc. [2] but here in our project we have food type as fruits, processed vegetables, raw vegetables, non-vegetables and then the app also ask for the donor for quality and quantity. Then the app depends on the information given apply the food waste prevention technique specially food security and find out whether the food waste is available for the receiver and verify that it is secure for consumption. After the verification of food the details are saved on the database and then its notification is generated for the receivers. The database here we used is google firebase therefore we don't need to setup specific server separately.

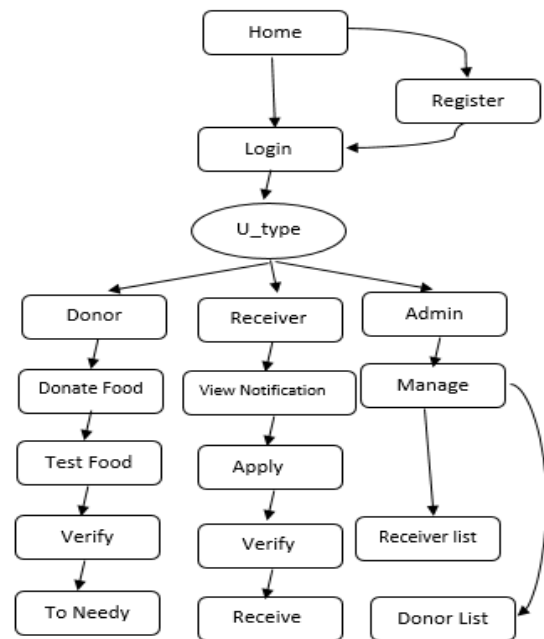

Fig. 2- Algorithmic Flow of FoodsApp application

The Fig2 demonstrate the flow of application which have the registration and login options once the user has logged in it will display the activity related to the users type as mentioned above if the user is donor then he will ask for donation and history also likewise the details are shown for each users.

CONCLUSION

In the FoodApp we use android based smartphones to use it to provide food wastage to the poor people, now a days android is used in many devices like TV, IoT internet of Things, android auto, smartphones and tablets so using all these availability of android it is possible to use the food sharing idea which will reduce the food wastage and provide the healthy food to the needy peoples. In this app we have developed the food donation functionality the food can be donated by those who have leftover food and can be received by those we require the food. This paper comes with idea of sustainable food prevention technique to provide healthy food distribution. In the future scope of this idea anyone can provide alternate solution for address of donor by accessing its GIS based location or by typing the address manually and secondly the composition module to this app which can be then used by farmers and other peoples who deals with compositions of food. Finally in this app can be used for social cause for ecofriendly culture and helping the needy people. With this app food wastage can be heavily reduced and this app will also work in

increasing the economy by supplying food to the need people.

ACKNOWLEDGMENT

Here with we are thanking our parents for motivating us our principal, vice principal and college management, Head of department for giving us opportunity to publish this work and lastly to our guide Miss Priya Patil madam for working with us.

REFERENCES

- [1] Komal Mandal ,Swati Jadhav, Kruti Lakhan "Food Wastage Reduction through Donation using Modern Technological Approach: Helping Hands" *International Journal of Advanced Research in Computer Engineering & Technology (IJARCET) Volume 5, Issue 4, April 2016*
- [2] Hitesh V. Raut¹, Swapnil R. Rajput², Dhananjay B. Nalawade³, Karbhari V. Kale⁴ "SMARTPHONE BASED WASTE FOOD SUPPLY CHAIN FOR AURANGABAD CITY USING GIS LOCATION BASED AND GOOGLE WEB SERVICES " *IJRET: EISSN:2319-1163 pISSN: 2321-7308*
- [3] Vivek S. Agrawal and Ambika Nag "Sustainable Food Waste Prevention Strategies to Achieve Food Security in India" *International Journal of Agriculture and Food Science Technology*.ISSN 2249-3050, Volume 4, Number 3 (2013), pp. 189-194© Research India Publications
- [4] Swapnil R. Rajput, Mohd Sohel Deshmukh, Karbhari V. Kale, PhD "Cross-platform Smartphone Emergency Reporting Application in Urban Areas using GIS Location based and Google Web Services" *International Journal of Computer Applications (0975 – 8887) Volume 130 – No.12, November 2015*
- [5] Dipali B. Gaikwad, Yogesh W. Wanjari and Karbhari. V. Kale "Accident Analysis System by Integration of Spatial Data Mining with GIS Web Services" *International Journal of Computer Applications (0975 – 8887) Volume 103 – No.10, October 2014*
- [6] Jethro B. de Guzman, Ritz Carlo C. de Guzman, and Engr. Remedios G. Ad "Mobile Emergency Response Application Using Geolocation for Command Centers" *International Journal of Computer and Communication Engineering, Vol. 3, No. 4, July 2014*
- [7] <https://play.google.com/store/apps/details?id=com.wastenofood.app&hl=en> [Accessed: January 2016].
- [8] <http://wastenofood.org/> [Accessed: January 2016]
- [9] Jethro B. de Guzman, Ritz Carlo C. de Guzman, and Engr. Remedios G. Ado, " Mobile Emergency Response Application Using Geolocation for Command Centers", *International Journal of Computer and Communication Engineering, Vol. 3, No. 4, 2014, pp.235-238.*
- [10] Kumar, S.; Qadeer, M.A.; Gupta, A., "Location based services using android (LBSOID)," in *Internet Multimedia Services Architecture and Applications (IMSAA), 2009 IEEE International Conference on*, vol., no., pp.1-5, 9-11 Dec. 2009.
- [11] JQuery Mobile "<https://jquerymobile.com/>" [Accessed: August 16,2015]
- [12] SQLite Database "<https://www.sqlite.org/>" [Accessed: August 16,2015]
- [13] Fuming Shih, Oshani Seneviratne, Ilaria Liccardi, Evan Patton, Patrick Meier, Carlos Castillo, "Democratizing mobile app development for disaster management ", *AHP '13 Joint Proceedings of the Workshop on AI Problems and Approaches for Intelligent Environments and Workshop on Semantic Cities, Pages 39-42.*
- [14] Appdynamics, "https://www.appdynamics.com/media/uploadedfiles/White_Paper_Going_live_with_a_mobile_app_1.pdf" [Accessed: Oct 15, 2015].
- [15] [3]. Kumar, S. & Kevin, B. (2002). *The Evolution of Global Positioning System (GPS) Technology. Journal of Science Education and Technology, 11, 59-80.*
- [16] Vicentini, F. Giusti, A., Rovetta, A., Fan, X., He, Q., Zhu, M., & Liu, B. (2008). *Sensorized waste collection container for content estimation and collection optimization. Waste Management.29, 1467-1472.*

CSE-15 A Review on Retinex based Image Enhancement Techniques

Priyanka B. Waghmode¹

¹Student Computer Engineering,

¹GF's Godavari College of Engineering, Jalgaon-India

Mr. Nilesh Vani²

nileshvani@gmail.com

²Assistant Professor in Computer Engineering

²GF's Godavari College of Engineering, Jalgaon-India

Abstract : Retinex is a method of bridging the gap between images and the human observation of scenes. Retinex theory is a model of lightness and color perception of human vision proposed by Edwin Land in 1986. While the retinex theory was actually aimed at providing explanation of human color perception, it has led to various image enhancement algorithms called as retinex algorithms, which are usually used to enhance local image contrast. This paper presents a review of several image enhancement techniques based on retinex model.

Keywords: Retinex, image enhancement, single-scale, multi-scale, illumination estimation, Color Restoration.

1. INTRODUCTION

Retinex is the theory of human color vision proposed by Edwin Land to account for color sensations in real scenes. Color constancy experiments showed that color does not correlate with receptor responses. In real scenes, the content of the entire image controls appearances. A triplet of L, M, S cone responses can appear any color. Land coined the word "Retinex" (the contraction of retina and cortex) to identify the spatial image processing responsible for color constancy. Further, he showed that color sensations are predicted by three lightness's observed in long-, middle-, and short-wave illumination. Retinex is also used as the name of computer algorithms that mimic vision's spatial interactions to calculate the lightness's observed in complex scenes.

Edwin H. Land, the inventor of hundreds of film patents, was struck by experiments showing that color sensations in real complex images depend on scene content. Film responds to the light falling on each

tiny local region. Land realized that vision's mechanisms were very different from film. His early experiments studied the color's observed in red and white projections. He realized color appearance required both the cone responses to a local region and the neural spatial processing of the rest of the scene. He proposed the Retinex Theory.

Land coined the word Retinex to describe three independent spatial channels. In 1964 he wrote: "We would propose that all of the receptors with maximum sensitivity to the long-waves in the spectrum, for example, operate as a unit to form a complete record of long-wave stimuli from objects being observed. (For convenience of reference, let us call this suggested retinal-cerebral system a "retinex."). It is the word that describes the mechanism that performs the comparison of scene information to create the array of sensations of lightness in three channels.

2. RETINEX IN IMAGE PROCESSING

Land described that the fundamental challenge of color vision shifted to the ability to predict lightness; that is, the spatial interactions found in post-receptor neural processes. In 1967 Land and McCann proposed a computational model for calculating lightness from the array of all scene radiances. The model compared each pixel with every other pixel in an image. The goal was to calculate the sensation of image segments that equalled what observers saw. In the past 50 years, there have been many implementations and variations of this process. They are called Retinex algorithms. It is curious that Land reserved the use of the term "Retinex" to describe three independent lightness channels. Today's usage of the word includes a much wider range of computer

algorithms that build calculated appearances out of arrays of radiances. To calculate lightness's in complex scenes, one must: Capture scene radiances, Convert scene radiances to cone and rod quanta catches, Calculate lightness using all pixels in the scene, Compare calculated lightness with observer matches. The Land and McCann model used: Edge ratios, Gradient threshold (found to be unnecessary in later studies), Multiplication of edge ratios (made long-distance interactions), Reset to maxima (scaled the output)(introduced dependence on scene content, e.g., simultaneous contrast) Average of many spatial comparisons. The first computer implementation of the model used an array of 20 by 24 pixels. McCann, McKee, and Taylor showed that long-, middle-, and short-wave computed lightness's predicted observer matches of color Mondrian's in color constancy experiments.

Since the late 1960s, computer imaging has shown remarkable advances. Digital images have replaced film in most of photography. Computer graphics has made image synthesis ubiquitous. Retinex image processing has grown with the advances in digital imaging. In the early 1980s Frackle and McCann introduced a multi-resolution algorithm that allowed efficient comparison of all pixels in the image. Jobson and Kotera with their colleagues have studied the NASA Retinex. Rizzi and colleagues have developed the Milan Retinex. Sobol extended that Retinex algorithm was used in the design of commercial cameras. Other algorithms have used Retinex spatial processing in color gamut-mapping applications.

The important feature of real complex scenes is that the illumination is rarely uniform. Shadows and multiple reflections increase the dynamic range of light coming to our eyes and to cameras. The application of Retinex algorithms to high dynamic range (HDR) scenes has become a major topic of research and engineering applications. The limits of HDR scene capture and reproduction are controlled by optics, namely, optical veiling glare. Camera glare limits the range of light on the sensor, just as intraocular glare limits the range of light on the retina. The scene content controls the range of light in images. Vision's post-receptor neural processes compensate for veiling glare. That explains humans' high dynamic range of appearances from low-dynamic-range retinal images. The spatial mechanisms modeled by Retinex algorithms play a

major role in compensating for glare and generating our range of color and lightness sensations.

Over the years many variations of spatial processing mimicking human vision have been called Retinex algorithms.

The different types of retinex algorithms are:

(i) Single Scale Retinex algorithm (SSR)

(ii) Multiscale Retinex algorithm (MSR)

(iii) Multiscale retinex with Color Restoration algorithm (MSRCR)

2.1 Single Scale Retinex Algorithm (SSR)

Single Scale Retinex, is the most basic method for Retinex algorithm. A low pass filter is applied on $I_i(x, y)$ which is the input color image to estimate the illumination. This illuminations log signal is subtracted to get the output color image $R_i(x, y)$. It is a 2D convolution of Gaussian surround function and its component of the original image.

It is given by ,

$$R_i(x, y) = \log [I_i(x, y)] - \log [F(x, y) * I_i(x, y)] \quad \dots (1)$$

Where $i=1 \dots S$. Here,

$$F(x, y) = K \exp [-(x^2 + y^2)/c^2] \quad \dots (2)$$

is Surround Function, S is the number of spectral bands, c is surround constant or scale value and selection of K is such that $\iint F(x, y) dx dy = 1$.

The log function in SSR is placed after the Gaussian surround function. A canonical gain offset is used as a postretinex signal processing. A space constant of 80 pixel is a good compromise between dynamic range compression and tonal rendition.

A single scale cannot simultaneously provide dynamic range compression and tonal rendition. The images are either locally or globally grayed out or suffered from color distortion due to violations of the gray world assumptions. These are the drawbacks of SSR[6].

2.2 Multi Scale Retinex Algorithm (MSR)

Single-scale Retinex cannot provide both the dynamic range compression and tonal rendition. MultiScale Retinex (MSR) [4] is developed to combine the strength of different surround spaces. The Gaussian filters of different sizes are used to process input image several times. The resulting images are weighted and summed to get output of MSR.

It is given by [3]

$$R_i(x, y) = W_n \log I_i(x, y) - \log [F_n(x, y) * I_i(x, y)] \dots (3)$$

Where $i=1, \dots, S$.

Here, W_n represents the weight for the net scale, N is number of scales.

MSR provide color enhancement. It also provides dynamic range compression and tonal rendition. The halos are reduced by using MSR.

But MSR output images violate gray world assumptions. So it suffers from greying out of the image, either globally or locally. This gives a washed out appearance. This is the main drawback of MSR algorithm.[4]

2.3 Multi Scale Retinex with Color Restoration Algorithm (MSRCR)

To restore color, MSR is modified by adding a color restoration function. The color restoration factor is given by:

$$\alpha_i(x, y) = f \left[\frac{I_i(x, y)}{\sum_{n=1}^N I_n(x, y)} \right] \dots (4)$$

It is the color restoration coefficient in the i th spectral band. The number of spectral bands is given by K . MSRCR algorithm is given by,

$$R_i(x, y) = \alpha_i(x, y) \sum_{k=1}^K W_k \log I_i(x, y) - \log [F_k(x, y) * I_i(x, y)] \dots (5)$$

The block diagram of MSRCR algorithm is shown in fig.1 MSR algorithm fails to meet Grey World Assumption. This problem can be removed by using color restoration method. Thus a color restoration factor (CRF) block is added with the MSR block to obtain the MSRCR algorithm.[4]

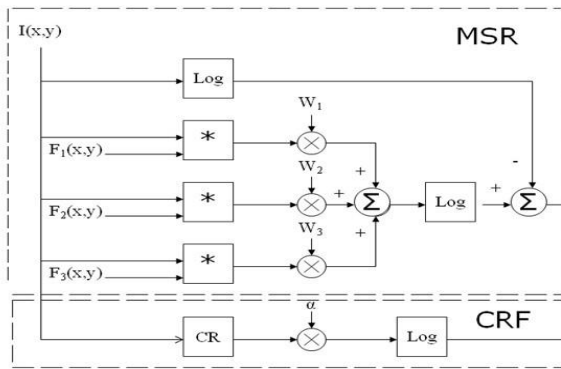

Fig.1 Block Diagram for MSRCR Algorithm

3.1 Illumination Estimation for Image Enhancement based on Retinex Model

This section shows the algorithm for retinex based image enhancement referred from IEEE transaction "Naturalness Preserved Non-Uniform Illumination Estimation for Image Enhancement Based on Retinex" by Yuanyuan Gao, Hai-Miao Hu, Bo Li and QiangGuo" [5].

3.1.1 Coarse Illumination Estimation using Extension of Max-RGB

3 NATURALNESS PRESERVATION IN RETINEX

Since Retinex-based algorithms regard illumination removal as a default preference and fail to limit the range of reflectance, the naturalness of non-uniform illumination images cannot be effectively preserved. However, naturalness is essential for image enhancement to achieve pleasing perceptual quality. In order to preserve naturalness while enhancing details, instead of removing the illumination, its transformation is useful. The following section shows the naturalness preserved Retinex based algorithm for non-uniform illumination. Here, illumination is estimated, assuming that in a local patch it is constant. Thus the Max-RGB algorithm is extended to take into account the local area of a pixel while estimating the maximum response of each colour channel. Formally, for an image I , the coarse illumination is defined as:

$$I^{ie}(x, y) = \max_{c \in \{R, G, B\}} (\max_{(x, y) \in \Omega} (I^c(x, y)))$$

Algorithm for Estimating Illumination

Input: I input color image

Output: Coarse illumination estimation I_{ie}

begin

foreach pixel I[x,y]:

// Find maximum values of the three channels in a local area

Max_red = Maximum value of red channel among all the pixels in local area

Max_blue = Maximum value of blue channel among all the pixels in local area

Max_green = Maximum value of green channel among all the pixels in local area

// Find maximum among these maximum values of these individual Channels

Max = maximum of Max_red, Max_blue and Max_green

I_{ie}[x,y] = Max

endFor

end

3.1.2 Illumination Estimation by joint Edge Preserving Filter with Step-up Function and Range Kernel Function

a) Introducing a guidance image

To compensate the edge region of the illumination, a maximum channel is introduced as guidance image L:

$$L(x, y) = \max_{c \in \{R, G, B\}} (I_c(x, y))$$

where L is a theoretical lower bound of illumination and keeps edges completely.

b) Joint-edge preserving filter

Next, a content adaptive joint edge preserving filter is defined, which combines a

step-up function and a range kernel function. It is defined as:

$$K(x, y) = \left[\frac{\sum_{(i,j) \in \Omega} \eta(i, j) \varphi(i, j) I^{ie}(i, j)}{\sum_{(i,j) \in \Omega} \eta(i, j) \varphi(i, j)} \right]$$

c) Step-up Function

The step up function η is defined as:

$$\eta(i, j) = \begin{cases} 1, & I^{ie}(i, j) - L(x, y) \geq 0 \\ 0, & \text{else} \end{cases}$$

d) Exponential Range Function

Exponential Range Function φ is defined as:

$$\varphi(i, j) = \exp\left(-\frac{|I^{ie}(i, j) - L(x, y)|}{2\sigma^2}\right)$$

3.2 Obtaining Reflectance

The reflectance R(x, y) can be obtained by removing the illumination:

$$R_c(x, y) = I_c(x, y) / L_r(x, y)$$

The reflectance image presents the details and the illumination image presents the ambience of incident light, which is in accordance with our previous analysis.[8]

3.3 Illumination Mapping Using the Bi-Log Transformation

As the mapped illumination will be synthesized with the reflectance to get the final enhanced image, it should not suppress the details so that it should be bright enough, and meanwhile the lightness order should be preserved. Inspired by that histogram specification is able to preserve the lightness order. The log shape, given by, performs well for most images.

$$Llg(x, y) = \log(L_r(x, y) + \epsilon)$$

where ϵ is a small positive constant and is empirically set as 1.

However, the intensity of the images processed by histogram specification appears similar. The weighted histogram is utilized, mp(n), instead.

$$mp(k) = \frac{\sum_{i=0}^m \sum_{j=0}^n Llg(i, j) \cdot U(Lr(i, j), k)}{\sum_{i=0}^m \sum_{j=0}^n Llg(i, j)}$$

$$U(x, y) = \begin{cases} 1, & \text{for } x = y \\ 0, & \text{else} \end{cases}$$

where δ is the impulsive function. According to the definition of the Cumulative Density Functions (CDF), the CDF of the weighted histogram is:

$$cL(v) = \frac{\sum_{k=0}^v mp(k)}{\sum_{i=0}^m \sum_{j=0}^n Llg(i, j) \cdot U(v, Lr(i, j))}$$

Similarly, the CDF of the specified histogram, $s(z)$, is defined as follows:

$$cf(z) = \frac{\sum_{i=0}^z s(i)}{\sum_{i=0}^{255} s(i)}$$

$$s(z) = \log(z + \epsilon), \quad z \in N[0, 255]$$

where z is a non-negative integer within $[0, 255]$, ϵ is a small positive constant. According to the definition of histogram specification [23], [24], the purpose of BLT is to seek values of z that satisfies

$$cf(zv) = cL(v), \quad \text{for } v = 0, 1, 2, \dots, L-1$$

The values of z is given by

$$z = cf^{-1} [cL(Lr(x, y))] \quad , \text{ for } v = 0, 1, 2, \dots, L-1$$

The mapped illumination can be obtained through the BLT transformation.

$$Lm(x, y) = cf^{-1} [cL(Lr(x, y))] \quad , \text{ for } v = 0, 1, 2, \dots, L-1$$

3.4 Synthesis of Reflectance and Mapped Illumination

The synthesize $R(x, y)$ and $Lm(x, y)$ together to get the final enhanced image:

$$E I_c(x, y) = R_c(x, y) \times Lm(x, y).$$

CONCLUSION

Retinex theory which was originally developed to explain the human color perception by Edwin Land has inspired many image enhancement algorithms. All these algorithms are collectively called retinex algorithms. This paper provides a brief review of image enhancement techniques based on retinex model.

REFERENCES

- 1] Meylan and S. Susstrunk, "High dynamic range image rendering with a retinex-based adaptive filter," IEEE Transactions on Image Processing, vol. 15, no. 9, pp. 2820–2830, Sept 2006
- 2] Z. urRahman, Jobson, and Woodell, "Multi-scale retinex for color image enhancement," International Conference on Image Processing, IEEE, vol. 3, pp. 1003–1006, Sep 1996
- 3] Z. u. Rahman, D. J. Jobson, and Woodell, "Retinex processing for automatic image enhancement," Journal of Electronic Imaging, vol. 13, no. 1, pp. 100–110, 2004
- 4] Contrast Enhancement Of Color Images Using Improved Retinex Method, by Neethu Simon Student, VLSI and Embedded System, ASIET, Kerala, India and Ajay Kumar ,Asst.Professor, VLSI and Embedded System, ASIET, Kerala, India, IJRET: International Journal of Research in Engineering and Technology, eISSN:2319-1163 | pISSN: 2321-7308
- 5] Naturalness Preserved Non-Uniform Illumination Estimation for Image Enhancement Based on Retinex by Yuanyuan Gao, Hai-Miao Hu, Bo Li and Qiang Guo, IEEE transaction on multimedia.
- 6] Naturalness Preserved Enhancement Algorithm for Non-Uniform Illumination Images

National Conference on Current Trends in Engineering, Science and Technology (NACCTEST-2018)

Organized by GF's Godavari College of Engineering, Jalgaon
International Journal of Innovations in Engineering and Science, Special Conference Issue,
2018

www.ijies.net

Shuhang Wang, Jin Zheng, Hai-Miao Hu, and
Bo Li IEEE TRANSACTIONS ON IMAGE
PROCESSING, VOL. 22, NO. 9, SEPTEMBER
2013

CSE-16 Priority based Algorithm for Automatic Question Paper Generation

Mr. Aditya p Kulkarni¹, Mr. Mayur Kakade², Mr. Shaikh Ashfaque³

¹ Student

GF's Godavari COE Jalgaon (MS), India, 425001

² Student

GF's Godavari COE Jalgaon (MS), India, 425001

³ Assistant professor

sk.ashfaque.shaikh@gmail.com

GF's Godavari COE Jalgaon (MS), India, 425001

Abstract –Now a days, education is the supreme significant way of accomplishing success. When we deal with the education, the traditional and best suitable way to analyze the impact of education is by conducting the examination. But the world is growing faster and use of ICT is too common everywhere. Examinations make students to let them prepare in their quest for understanding. The traditional method and most widely used method is by generating the paper manually. In this technique definite official's workout and writes the question paper or type the paper. But this technique is inefficient because it is time consuming and unsecured because the leak of paper may happen by simply guessing the paper and its format. Because the officials are limited hence they can easily know which kind of questions they can have. Hence we have proposed an algorithmic based automatic question paper generation system. We have proposed an automated process of Question Paper Generation which is fast and greedy algorithm based algorithmic solution for selection problem. It is secure and randomized algorithm which can be suitably applied to select the questions from the given set and subsets of questions. This system is fully automatic hence there is no problem security threats anymore. Meanwhile this system is fully secured, robust and can select best suitable questions for question paper generation. This system assigns priorities to question depend on the wattage of syllabus and importance of topics to the questions and depend on the priority randomly questions are selected as mentioned above it greedy algorithm based solution which finds the suitable n selections and depend on the priority one is selected.

Keywords— question paper generation; paperless; automation; randomization; information communication technology (ICT)

1. INTRODUCTION

Education is the tedious and important aspect of being able to do something now a days There is a countless affluent in e-learning in the area of technology-enhanced Intelligent Tutoring Educational Systems where excellent virtual instructors/teachers which guide their learners/students. Growth has been made, addressing a variability of educational needs, ranging from enhancements to existing “traditional” courses, to complete on-line programs. Despite all this effort, hype, and even product development, most of the courseware material available for use at the educational level is still not judged to be as effective as a teacher lecturing and leading discussions with students.

However, it is difficult to make a fair online evaluation of how well the students understanding. There are several disturbances for realizing fair grading such as mere duplication of answers between the students or illegally pretending to be other persons to answer the exam.

An online question bank and examination system is a relatively new and rapidly expanding system. Although it is an effective solution for mass education evaluation, the fairness of the evaluation is still a big concern. Most of the present systems were designed to grade students based on how well they have done on their examination.

These systems were designed with the concept of traditional paper based examination in mind. There is

a need to use a range of different We have proposed here an automated method of Question Paper Generation which is fast and greedy algorithm based algorithmic solution for selection problem. It is secure and randomized algorithm which can be suitably applied to select the questions from the given set and subsets of questions. This system is fully automatic hence there is no problem security threats anymore. This system assigns priorities to question depend on the wattage of syllabus and importance of topics to the questions and depend on the priority randomly questions are selected as mentioned above it greedy algorithm based solution which finds the suitable n selections and depend on the priority one is selected. This system is fully secured, robust and can select best suitable questions for question paper generation.

2. RELATED WORK

The research paper „Framework for Automatic Examination Paper Generation System“ has provided a thorough insight into the process of automated paper generation [8]. As the manual generation of a balanced question paper by an individual is quite complex, the blending of technology into teaching and learning process is inevitable. A simple and efficient way for an examination paper generation is provided. A three tier model is provided in this framework [8]. Generation of Examination Papers is governed by the Syllabus Engine, Pattern Composer and Question Aggregator. The generated question paper is based on the pattern or skeleton of the course. Another component called Bank Management takes care of User Rights and Privilege assignment. Questions are entered through the Question Aggregator. The attributes related to questions are type, marks and complexity. All these attributes are efficiently used during Question Paper Generation [8]. The paper generator selects a question according to the pattern and complexity. This engine also introduces a marking systems wherein any selected question is marked so that it might not be selected again. This prevents repetition of questions in subsequent papers. Finally, generated papers are stored as pdfs [8]. The paper on „Automatic Question Paper Generation System using Randomization Algorithm“ describes a system which uses a shuffling algorithm (existing algorithm) as a randomization technique [8]. The system defines several modules such as user administration, subject selection, difficulty level specification, question entry, question management, paper generation, and paper management [8]. It supports multiple languages. Also, mathematical formulae and

diagrams can be integrated in questions. The system has a dual interface viz., web-based and desktop-based [8]. The system introduces a highly efficient shuffling algorithm which uses an array to store randomly generated numbers. The questions are then selected against these array elements, thereby ensuring completely random generated question papers. However, this system fails to utilize the highly efficient marking system. So, questions once selected may be repeated in subsequent papers. This is a limitation of this system [8]. The „Question Paper Generator System“ has provided a ready to use built-in question bank [8]. The paper aptly describes CQZ (Cloze Question Generation) putting more emphasis on the actual type of the questions [8]. Another paper on „Automatic Test Paper Generation Based on Ant Colony Algorithm“ has implemented a complex but highly efficient Ant Colony Algorithm [8]. It requires building of a mathematical model of constraint according to the requirements of the paper. This paper provides an efficient solution with their algorithm [8]. The paper on „An Integrated Automated Paperless Academic Module for Education Institutes“ has stated the importance and working of switching from Paper based systems to Paperless Systems [8]. The importance of automation is very well documented in the context of Task Engineering [8]. The paper also clearly defines the importance of Information and Communication Technology (ICT) in academics and educational organizations [8].

The paper also describes many Access Control Methods such as MAC (Mandatory Access Control), DAC (Discretionary Access Control), RBAC (Role based Access Control) and DTE (Domain Type Enforcement) [8]. Role based Access Control is very helpful in automation due to the user hierarchy comprising of different roles [8].

3. METHODOLOGY

The issue of best feature selection is difficult. The extensive search procedure is appropriate for lower-dimensional problems only. A well-known alternative to extensive search is the Branch & Bound algorithm. The Branch & Bound algorithm is a “top-down” algorithm with backtracking. It is based on the assumption that the adopted criterion function fulfills the monotonicity condition and many feature subset evaluations may be omitted. Here with this system the the algorithm used for searching of question is as follow

Algorithm:

Consider Q questions available in database for each q in Q we have Priority P and threshold of priority t .

1. Create main List L of Q questions
2. Read Paper Format priority(marks) and and number of questions to be selected n .
3. Repeat 4 to 8 till length of $D=n$
4. Create a Set D of Q question's
5. Select q from D by randomly generating index of set D . where $q \in Q$.
6. If $t \geq P(q)$ jump to step 2.
7. If $q \in D$ jump to step 2.
8. Store q in D
9. Store D in L .

The Question inventory Q is the number of questions available for selection and marks are denoted by priority the question paper selection is done by selecting the different questions q of various priorities each priority set is first calculated in D and then finally concatenated to main question list L . using this algorithm we have proposed a different system for automatic paper generation which is based on the prioritizing the question that are selected and by randomizing the question selection this system is totally automatic system. This system has revised this existing algorithm by incorporating an effective priority and its threshold value for questions in our proposed algorithm. The administrator will have complete power over all tasks and users. Also, the system is fully customizable according to any educational institute and course structures. Secure Algorithms are used to store admin and user passwords to enhance security. This algorithm uses a basic randomization algorithm

4. DESIGN

This Question Paper Generator System is developed and built up using Java programming language. This paper implementation done with different modules of courses, questions and patterns of question papers. Then it executes the algorithm on

the database of questions and then generates the question paper. Modules in system are as Paper Generator:

1. Register and Login Module
2. User Module (staff, students, and admin)
3. Entry module (Subject, Questions, and priority)
4. Paper generation and validation

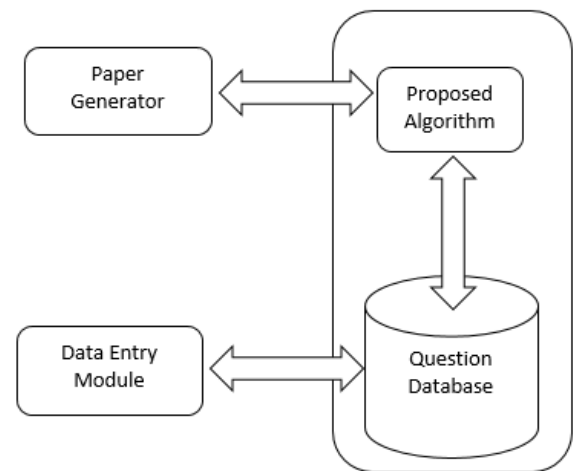

Fig1: Architecture of Priority Based Paper Generator

Login Module there are two types of users we have one is administrator, second is teachers and staff. Administrator will monitor the working of the system manage the staff and their roles their subject assignment etc. next the data entry module where we have space for each registered users they can enter their own questions and then they can generate their own question paper using the questions they have on their database. And the last module which generate the question paper executes the algorithm given in this research. Starting with this system authorized user will register, after the successful registration login ID and Password will be generated of that user then the system will redirect the user to its home page where he can manage the profile and dashboard. From dashboard he can select the options like data entry and question paper generation then if

he selects the data entry option it will ask him to enter question bank with details like priority and subjects in future we can update this system to provide more granular priorities and role based access security to this system

ACKNOWLEDGMENT

First of all we would like to thank our college management for giving us opportunity to publish this paper. Then we are thankful to our principal, vice principal and Head of department for encouraging us and helping us in this work. Next to our respected guide Prof Ashafaque shaikh Professor in Department of Computer Engineering for introducing me throughout features needed. The time-to-time guidance, encouragement, and valuable suggestions received from him are unforgettable in our life. This work would not have been possible without the enthusiastic response, insight, and new ideas from him.

CONCLUSION

In this paper a new priority based automatic question paper generation is made with the help of algorithm updated from the automatic question paper generation. This system uses priorities of question for generation of paper and depend on the priorities it generates question paper. Algorithm uses threshold value for the selection of question and to allow feasibility to select question paper different pattern. System. Using this algorithm and system one can easily generate question paper and can construct different formats of question. For fill in the blank and multiple choice questions user will have to enter the options also in the question paper.

REFERENCES

- [1] Rohan Bhirangi, Smita Bhoir "Automated Question Paper Generation System" International Journal of Emerging Research in Management & Technology ISSN: 2278-9359 (Volume-5, Issue-4)
- [2] Surbhi Choudhary, Abdul Rais Abdul Waheed, Shrutika Gawandi and Kavita Joshi, "Question Paper Generator System," International Journal of Computer Science Trends and Technology, vol. 3, issue 5, Sept – Oct 2015.
- [3] Prita Patil and Kavita Shirsat, "An Integrated Automated Paperless Academic Module for Education Institutes," International Journal of Engineering Science Invention Research and Development, vol. I, issue IX, March 2015.
- [4] Ashok Immanuel and Tulasi.B, "Framework for Automatic Examination Paper Generation System," International Journal of Computer Science Trends and Technology, vol. 6, issue 1, Jan - March 2015.
- [5] Kapil Naik, Shreyas Sule, Shruti Jadhav and Surya Pandey, "Automatic Question Paper Generation using Randomization Algorithm," International Journal of Engineering and Technical Research, vol. 2, issue 12, December 2014.
- [6] Dan Liu, Jianmin Wang and Lijuan Zheng, "Automatic Test Paper Generation Based on Ant Colony Algorithm," Journal of Software, vol. 8, no. 10, October 2013.
- [7] Moinuddin Qadir, "Role of Automation in Computer-based Systems," unpublished.
- [8] Ashok Immanuel , tulsi B "Framework for Automatic Examinaton Paper generation System" IJCST Vol6, Issue 1, Jan-March

CSE-17 Finger Matching Using Ratio Of Relational Distances & point Matching

Anil K.Jain¹, Tasneem Bakerywala², Rahul Gaikwad³, Pramod Gosavi⁴

^{1,2}Student

GF's Godavari COE Jalgaon (MS), India, 425001

³Lecturer

gaikwad005@gmail.com

GF's Godavari COE Jalgaon (MS), India, 425001

⁴Assistant professor

gosavi.pramod@gmail.com

GF's Godavari COE Jalgaon (MS), India, 425001

Abstract – We present a fingerprint matching algorithm that initially identifies the candidate common unique (minutiae) points in both the base and the input images using ratios of relative distances as the comparing function. A tree like structure is then drawn connecting the common minutiae points from bottom up in both the base and the input images. Matching score is obtained by comparing the similarity of the two tree structures based on a threshold value. We define a new term called the 'M (i) - tuple' for each minutiae point which uniquely encodes details about the local surrounding region, where $i = 1$ to N , and N is the number of minutiae. The proposed algorithm requires no explicit alignment of the two to-be compared fingerprint images and also tolerates distortions caused by spurious minutiae points. The algorithm is also capable of comparing and producing matching scores between two images obtained from two different kinds of sensors, hence is sensor interoperable and also reduces the FNMR in cases where there is very little overlap region between the base and the input image. We conducted evaluations on the FVC-2000 [1] datasets and have summarized the results in the concluding section. Fingerprint matching has been successfully used by law enforcement for more than a century. The technology is now finding many other applications such as identity management and access control. The authors describe an automated fingerprint recognition system and identify key challenges and research opportunities in the field. A fingerprint verification system based on triangular matching and dynamic time warping is proposed which provides better results especially for poor quality fingerprint images. An existing reference

fingerprint image must validate the identity of a person by means of a test fingerprint image acquired online and in real time using minutiae matching. The matching system consists of an information extraction block and matching block.

1. INTRODUCTION

A fingerprint is the pattern of ridges and valleys on the surface of the finger. The uniqueness of a fingerprint can be determined by the pattern of ridges and furrows as well as the minutiae points. Minutiae points are local ridge ending. Even identical twins having same face and genes are said to have different fingerprint. Among all the biometrics fingerprint based identification is one of the most mature and proven technique. Fingerprint is an impression formed through deposit of minute ridges and valleys when a finger touches a surface. Facts exist that the ridges and valleys do not change throughout lifetime no matter what happens and in a case of injury or mutilation, they reappear within a short period. The five commonly found fingerprint ridge patterns are arch, tented arch, left loop, right loop and whorl (Figure 1) [1 - 6]. Fingerprint has proved to be a very reliable human identification and verification index and has enjoyed superiority over other biometrics such as ear, nose, iris, voice, face, gait and signature [7]. The uniqueness of the ridges and valleys makes it immutable and therefore serves a strong mark for identity. Fingerprint based biometric authentication and verification systems have gained immense popularity and acceptance ever since their inception. This is primarily because of the ease of operation, installation and easy acquisition of the biometric feature, which in this case is a fingerprint. Matching two fingerprints can be unsuccessful due to various reasons and also depends upon the method that is

being used for matching. Very popular methods include minutiae based matching, correlation based matching, pattern matching etc... The quality of fingerprints often plays a major role in affecting the degree of accuracy of the result produced by the matcher. In this paper, we have solely concentrated on attacking two problems, the first being the increased FNMR when the overlap region is very less in area and the second being the sensor interoperability problem, as indicated by Jain et al . The quality of fingerprints can be perceived as a problem in two major cases. [a] Fingerprint quality often deteriorates based on the acquisition device from which it was obtained with respect to overlap regions. While an optical scanner may be able to produce an image as large as 500 * 500 pixels with 500 dots per inch, a solid state scanner will be able to produce an image with dimensions of 300 *300 only. What this effectively means is that, while fingers are placed at different positions on the platen of the scanner at various instances, an optical scanner will be able to capture more area at all times, hence the overlap region between the base and the input image is always considerable enough in area to perform a match. But in a system that deploys solid state acquisition devices, this common area or the overlap region might be low enough to an extent that either a match could not be performed or the result is not accurate when the matching process is executed..A fingerprint is the pattern of ridges and valleys on the surface of the finger. The uniqueness of a fingerprint can be determined by the pattern of ridges and furrows as well as the minutiae points. Minutiae points are local ridge characteristics that occur at either a ridge bifurcation or a ridge ending. Even identical twins having same face and genes are said to have different fingerprint. Among all the biometrics fingerprint based identification is one of the most mature and proven technique..Most classical fingerprint recognition algorithms tak the minutiae and the singular points, including their coordinates and direction, as the distinctive features to represent the fingerprint in the matching process. Minutiae extraction mainly includes steps such as ridge ending and ridge bifurcation, ridge extraction or enhancement and minutiae extraction. Then the minutiae feature is compared with the minutiae template; if the matching score exceed a predefined threshold, these two fingerprints can be regarded as belonging to a same finger. The main points addressed in automatic systems are: fingerprint acquisition, verification, identification, and classification

Numerous algorithms have already been proposed to deal with fingerprint matching an recognition. Jain et al proposed a filterbank matching algorithm that employs gabor filters to obtain both local and global information which in turn becomes a FingeCode. Matching is based on comparing the Euclidean distances between two such FingerCodes. In [4], a hybrid matching algorithm that considers both minutiae point data and texture information is detailed. A few graph based algorithms do matching by performing operations based on graph principles. The algorithm [8] proposed by Nalini K Ratha et al creates two Minutiae Adjacency Graphs, one each for the base and the input image, in which the vertices of the graph represent minutiae from the matched minutiae set. The algorithm proceeds in three phases to arrive at the matched minutiae set. The first phase results in a minimum set of matched node (minutiae) pairs based in their neighborhood information. The second phase results in an increased set of matched pairs by comparing the distances from the unmatched minutiae set to the matched minutiae set, which indeed was obtained because of the first phase. The algorithm proceeds to the third phase in which the neighborhood of each feature is extended, if a decision could not be arrived at the end of the second phase. Point Pattern Matching problems ([9] and [10]) are also used in fingerprint matching though they are computationally expensive.] proposes a solution to fingerprint matching by incorporating ideas associated with point pattern matching problem. Werner Olz and Walter Kropatsch proposed an algorithm [12] that brings the entire ridge topology into consideration. Each ridge is assigned a symbol based on their kind, which includes a ridge ending, ridge bifurcation etc... These symbols are considered to be nodes/vertices of a graph, and two such graphs that are drawn from the entire ridge topology of the base and the input image is compared to arrive at a result. Fingerprint Classification and indexing techniques are prevalent, some of which discriminate between fingerprints based on the appearance of the core area. In [16], a new term called K-plet is introduced, which may either refer to 'K' nearest neighbors of a minutia or all neighbors within a circular radius etc... An adjacency graph is drawn for each of the K-plets and then the CBFS (Coupled Breadth First Search) algorithm is used to traverse through the nodes of the graphs to produce a matching score. The K-plet construction and the resulting adjacency graphs are used to match local regions within both the images, while CBFS consolidates all the local matches. In multiple feature descriptors and classifiers are used in

RELATED WORK

parallel to enhance the result of the matching process. Techniques discussed I which we] try to align the global patterns of the ridges and valleys rather than matching minutiae points only. We realized the importance of simultaneously considering both local information and global features from the above papers. The proposed algorithm in this paper considers each of the minutiae point in the base image to be a candidate common point minutiae (a common point minutiae is one that is available in both the base and the input image) initially, and derives the 'M (i) – tuple 'for all the minutiae. Then the M (i) - tuples are computed for minutiae points in the input image and are compared to the already computed tuples from the base image. Based on tuple matching, common point minutiae sets (set of points that are available in both in the base and the input image) are obtained. Note that we will have two such sets, one from the perspective of the base image and one from the perspective of the input image. The reason why we will have two sets is explained in section. After these sets are obtained, a tree like structure is drawn between the minutiae points in both the sets and the trees are compared to arrive at a matching score result. The above overview of the proposed algorithm is explained in great detail in the following section. Biometrics is the science of verifying the identity of an individual through physiological measurements or behavioural traits.. Since biometric identifiers are related permanently with the user, they are more reliable than token or knowledge based authentication methods. Several benefits of biometrics over typical security measures are:

(a) Non-repudiation: With token and password based approaches, the perpetrator can always deny committing the crime pleading that his/her password or ID was stolen or compromised even when confronted with an electronic audit trail. There is no way in which his claim can be verified effectively. This is known as the problem of deniability or of "repudiation". However, biometrics is indefinitely associated with a user and hence it cannot be lent or stolen making such repudiation infeasible [6].

(b) Accuracy and Security: Password-based systems are susceptible to brute force attacks. Such systems are as exposed as their weakest password. In contrast, biometric authentication requires the physical presence of the user and therefore cannot be circumvented through brute force style attack. Biometrics has also been shown to possess a higher bit strength compared to password-based systems and is therefore inherently more secure.

(c) Screening: In screening applications, users are prevented from assuming multiple identities, for example, a terrorist using multiple passports to enter a foreign country. This requires a process to ensure a person has not been enrolled under another assumed identity before adding the new record into the database. Such screening is not feasible using typical authentication mechanisms and biometrics provides a viable solution.

Traditionally fingerprints were acquired by transferring the inked impression onto the paper. This process is termed as off-line acquisition. Existing authentication systems are based on devices that capture the fingerprint image in real time. The live-scan devices can be based on one of the following sensing schemes:

- (a) Optical sensors
- (b) Capacitive sensors
- (c) Ultra-sound sensors
- (d) Thermal sensors

Optical sensors are the oldest and most widely used in fingerprint acquisition technology. In most devices, image of the fingerprint with dark ridges and light valleys is converted by a charged coupled device (CCD) into a digital signal. These devices are inexpensive and can provide resolutions up to 500 dpi. Most of the sensors acquire the image by using Frustrated Total Internal Reflection (FTIR) technique where a source illuminates the fingerprint through one side of the prism. Most of the light is reflected back to the other side due to internal reflection phenomenon, where it is then recorded by a CCD camera. In regions where the fingerprint surface touches with the prism, the light is diffused in all directions and consequently does not reach the sensor, resulting in dark regions. Furthermore, a wet fingerprint may affect the quality of the image .Optical sensors also faced another problem which is the residual patterns left by the previous fingers. It has also been shown that fake fingers are able to fool most low-grade commercial sensors [9]. Due to the optics involved, optical sensors are also among the bulkiest sensor.

In capacitive sensors, the silicon sensor acts as one plate of a capacitor while the finger acts as another other plate. The capacitance between the plate and the finger depends inversely with the distance between them. Since the ridges are closer, they relate to increased capacitance and the valleys relate to smaller capacitance. This variation is transformed into an 8-bit greyscale digital

image. Due to its small size, most of the electronic devices featuring fingerprint authentication utilize this form of solid state sensors

Ultrasound technology is possibly the most accurate fingerprint sensing technologies where it utilizes ultrasound waves and measures the distance based on the impedance of the finger, the plate, and air [12]. The sensors are capable of very high resolution of 1000 dpi or more. However, these sensors tend to be very huge and contain moving parts.

Thermal sensors are made up of pyro-electric materials whose properties change with temperature [13]. These are usually manufactured in the form of strips. As the fingerprints are swiped across the sensor, there is differential conduction of heat between the ridges and valleys (since skin conducts heat better than the air in the valleys) that is measured by the sensor. Full size thermal sensors are not practical since skin reaches thermal equilibrium very quickly once placed on the sensor leading to loss of signal. This would require us to constantly keep the sensor at a higher or lower temperature making it very energy inefficient. The sweeping action prevents the finger from reaching thermal equilibrium leading to good contrast images. However, since the sensor can acquire only small strips at a time, a sophisticated image registration and reconstruction scheme is required to construct the whole image from the strips.

METHODOLOGY

The algorithm proposes to match two fingerprints provided that their minutiae points are identified already. In order to test and verify our algorithm, we used the algorithm proposed by Sharat et al in [1], to extract minutiae points from a given fingerprint image. fingerprint image enhancement based on STFT (Short Time Fourier Transform) analysis to improve the overall clarity of a fingerprint image and also provides it in a binary format. We use [23] to obtain the enhanced binary image, after which we thin down the binary image down to a width of one pixel so as to retrieve minutiae points from the image. What we have now is a pair of fingerprint images with their minutiae points identified. The prime purpose of this phase is to find the number of common minutiae points available in a pair of fingerprint images. Given two fingerprint images with 'N1' and 'N2' identified minutiae points respectively (where N1 need not be equal to N2), this phase outputs

the 'M' common minutiae points, which would be available in both the images. Effectively, if N1 represents the set of minutiae points in image 1 and N2 represents the set of minutiae points in image 2, M would be the intersection of N1 and N2 ($M = N1 \cap N2$). We define a new term called the 'M (i) – tuple' to represent information about a minutiae that would identify it uniquely among the set of all minutiae. The M (i) – tuples of a pair of minutiae can be compared/matched to find if they both are the same or not. The method followed to arrive at M follows in the next sub-section. When two images with identified minutiae points are given as input, the algorithm

Step 1: For each minutiae $i = 1$ to $N1$, the 5 nearest minutiae points are found. This is done by calculating the Euclidean Distances from the 'i'th minutiae point to all the other minutiae points in the set N (BM) and noting down the 5 nearest minutiae points with respect to Euclidean Distances

Step 2: If $i1, i2, i3, i4$ and $i5$ are the 5 nearest minutiae points of i , then we calculate M (i) – tuple in the following way: (a) Calculate distances $i - i1, i - i2, i - i3, i - i4$, and $i - i5$. Note that distance ' $i - iN$ ' means the Euclidean Distance between the points i and iN . So here, distance $i - i1$ means the Euclidean distance between minutiae point i and $i1$ and so on. (b) Find the following 10 ratios $(i - i1) : (i - i2), (i - i1) : (i - i3), (i - i1) : (i - i4), (i - i1) : (i - i5), (i - i2) : (i - i3), (i - i2) : (i - i4), (i - i2) : (i - i5), (i - i3) : (i - i4), (i - i3) : (i - i5), (i - i4) : (i - i5)$ according to the following equation : $(a - b) : (a - c) = \frac{\text{Max} \{(a-b), (a-c)\}}{\text{Min} \{(a-b), (a-c)\}}$. ----- {1}

So all the ten ratios when calculated using would yield a number value that is definitely greater than 1. The decimals are rounded to two digits and the 10 values are entered in to the tuple. (c) While calculating the ratio of distances between $(a - b) : (a - c)$, the angle that is formed between 'bac' or 'cab' at 'a' is also calculated and entered in the tuple correspondingly near to where the ratio of $(a - b) : (a - c)$ is entered. Calculation of angles is also explained below. While comparing two tuples, one from the input image and one from the base image, those two tuples are considered to be the same if a minimum of 2 or more ratios along with the corresponding angles match. A matching of two ratios along with the angles means that for that particular minutiae ('i'), there is a similar corresponding minutiae ('isim') in the other image which also has two minutiae points at relational distances with specified angles, like 'i'. So the threshold for two tuples to match is two ratios along with the specified angles. All such matched tuples,

which invariably are minutiae points are strictly Candidate Common Points, which would be available in the both the images. No conclusion is arrived at, the end of phase 1. Two things will have to be explained here before proceeding to the matching phase. The first thing is to explain how two matching ratios is reason enough to accept a tuple/minutiae point as a Candidate Common Point.

Consider the following scenario. In fig 6, when ratios of distances of AB: AC, AC: AD along with their internal angles from the base image match with the ratios of AB: AD, AD: AE along with the internal angles from the input image,

The internal angles are given

a range of plus or minus 3.5 degrees to match, since, when comparing an image acquired from a solid state device with an image acquired from an optical device, the size of the images may differ by around more than $300 * 300$ pixels. For example, the base image may be a $300 * 300$ image from a solid state device, while the input image may be from an optical device with size $600 * 600$. For these sensor interoperable matches, the 3 degree range is given. If both the images are from the same sensor, a 1.5 degree range is more than enough . only one ratio matches, which is not good enough to say that the point A is a Common Point that lies in both the images. But checking the quadrant information for every minutiae point while trying to match the local neighborhood is a complex task computationally. Hence these points are also including the Candidate Common Point List for the time being, but are removed in the matching phase. This is explained in the matching section. In the following section, we discuss the matching phase by using a tree like structure. At the end of this phase, after checking each of the tuples from the input image with all the tuples from the base image, the algorithm results in producing the Candidate Common Point List.

1. Matching phase

The matching phase of the algorithm does two functions. (1) Separates the Candidate Common Points List into two lists, (a) Confirmed Common Points List and (b) Spurious / Unconfirmed Point List. (2) Uses the Confirmed Common Points List to generate a Matching Score between the Base and the Input image.

2 . Finding confirmed common points list

From $N(BM)$, which is the set of minutiae points in the base image, the algorithm considers only those points that feature in the Candidate Common Point List to create the tree. The remaining points in the set $N(BM)$

are listed in the set $N'(BM)$. After those points are considered, a tree like structure is drawn from bottom up. Similarly from $N(IM)$, algorithm considers points that feature in the Candidate Common Point List to create the tree and the remaining points are listed in the set $N'(IM)$. This is illustrated from figure 9. The Candidate Common Points in the Base and the Input image are ordered as follows. The lowest common point in both the images is considered to be the origin of an X –Y co-ordinate system. All the other points that are above this point are ordered with respect to their Y values (lower the Y value, lower the order, so the origin point is order 0, the next is order 1 and so on), and when two points happen to have the same Y value, the point with the lower X value is given the lower order.

Effectively the order increases bottom up in the image. After ordering all the Candidate Common Points, they are connected from bottom up with respect to their order in both the images, as shown .. Then, the algorithm does the following to eliminate spurious minutiae points by doing the following: In both the tree structures, if we consider the Candidate Minutiae Points to be Vertices and the lines connecting the vertices as edges, then the algorithm encodes the following information in each of the edges: Each edge carries information about (1) the quadrant to which it is moving, (2) ratio of its own length with the previous edge length calculated using {1}, hence this information is a number value greater than 1, (3) Angle created by the edge along with the extension of the previous edge. Dark lines in figure 9 represent edges flowing through the Candidate Common Points, while semi dark lines represent the X – Y coordinate system with the starting vertex of the edge or particular minutiae as the origin, and dark dotted lines indicate extension of the previous edge. The edge from B to C would contain the below mentioned information:

(a)

Quadrant to which it is moving, which in this case is 1st quadrant, and this is calculated by projecting an X –Y Co-ordinate system from the starting vertex of the edge, which is B here. The edge BC obviously moves to the first quadrant. (b) Ratio of edge lengths AB and BC is calculated based on {1}. (c) The minimum angle that is created by the edge BC with the extension line of the previous edge is noted. Similarly, these three information is calculated for each of the edges that connect the Candidate Common Points in both the images.

DESIGN

The system compares two fingerprint images, reference image and a test image. It is assumed that a reference image is available for the person to be identified and that it may be processed offline. The test image is obtained and used in real-time. It has to be compared to the reference image within a short time compatible with the application. The operation sequence applied to the reference image is shown in the information extraction block and the effective fingerprint matching is carried out on each test image, as shown in the matching block. The reference image is carefully filtered to reduce noise and to use the whole gray-scale dynamics. Since this operation is performed only once for each person to be identified, the filtering operation speed is not a primary requirement. The minutiae coordinate and the neighbouring minutiae list is extracted for each detected minutiae. A coarse and fast filter is applied to the original reference image and the region of 16*16 pixels around each minutiae point is saved in several rotated versions to cope with a possible significant global rotation. The test image is acquired by the same device as the reference image. It is filtered by the same coarse filter applied to the reference image leading to comparable images. The filtered test image is scanned by a moving window technique searching for possible correspondences between the reference minutiae regions and the test image. If some correspondences are found, a triangular matching is applied and a possible fingerprint matching is defined. Finally, this tentative matching has to be verified by dynamic time warping to overcome the strong local deformations.

The procedures of this block are applied to the reference image only. The main result of this processing is the real minutiae set of the fingerprint, minimizing the false minutiae and maximizing the true ones. The filter is based on the bidimensional Fourier transform and some nonlinear operators in the frequency domain in order to reduce low and high frequency noise.

A. Fine Filtering

The fine filter should reduce the noise as much as possible to facilitate the subsequent minutiae extraction operations. The filter is based on the dimensional Fourier transform and some nonlinear operators in the frequency domain in order to reduce low and high frequency noise.

B. Coarse Filtering

The image quality is improved by the coarse filtering procedure, expanding the gray-scale dynamics to the whole pixel depth. The coarse filter does not cope with

the noise in the frequency domain nor with ridge or valley interruptions. Since this filter is applied both on the reference and test images, it has to be fast and therefore simple. The coarse filtering procedure consists of the subsequent steps:

1. A four-neighbor average filter is applied to each pixel in the image to blur the image, reducing sharp local variations.
2. The image is split into $m * n$ regions, creating approximately $16 * 16$ pixel squares.
3. The average, maximum, and minimum pixel values are computed for each region.
4. A four-neighbor average filter is used to equalize the average, maximum, and minimum pixel values of the whole image.

C. Histogram Equalization

In order to enhance the contrast of the fingerprint image histogram equalization is adopted. Histogram equalization defines a mapping of gray levels p into gray levels q such that the distribution of gray level q is uniform. This mapping stretches contrast (expands the range of gray levels) for gray levels near the histogram maxima. Since contrast is expanded for most of the image pixels, the transformation improves the detectability of many image features. A fingerprint is the pattern of ridges and valleys on the surface of the finger. The uniqueness of a fingerprint can be determined by the pattern of ridges and furrows as well as the minutiae points. Minutiae points are local ridge characteristics that occur at either a ridge bifurcation or a ridge ending. Even identical twins having same face and genes are said to have different fingerprint. Among all the biometrics fingerprint based identification is one of the most mature and proven technique. Most classical fingerprint recognition algorithms take the minutiae and the singular points, including their coordinates and direction, as the distinctive features to represent the fingerprint in the matching process. Minutiae extraction mainly includes steps such as ridge ending and ridge bifurcation, ridge extraction or enhancement and minutiae extraction. Then the minutiae feature is compared with the minutiae template; if the matching score exceed a predefined threshold, these two fingerprints can be regarded as belonging to a same finger. The main points addressed in automatic systems are: fingerprint acquisition, verification, identification, and classification. Fingerprint acquisition is used to obtain the fingerprint image in some useful format. Fingerprint identity verification requires some knowledge of the person to be identified. The system is asked to accept or reject the hypothesis of

matching between a stored fingerprint image and the test image. Consequently, the system must match the person's characteristics directly against those stored as reference information. Identity recognition requires further efforts. The system must match the characteristic of the person

to be recognized against the whole set of characteristics stored in the database, thus deciding if one of the items of reference information is sufficiently similar to the one considered.

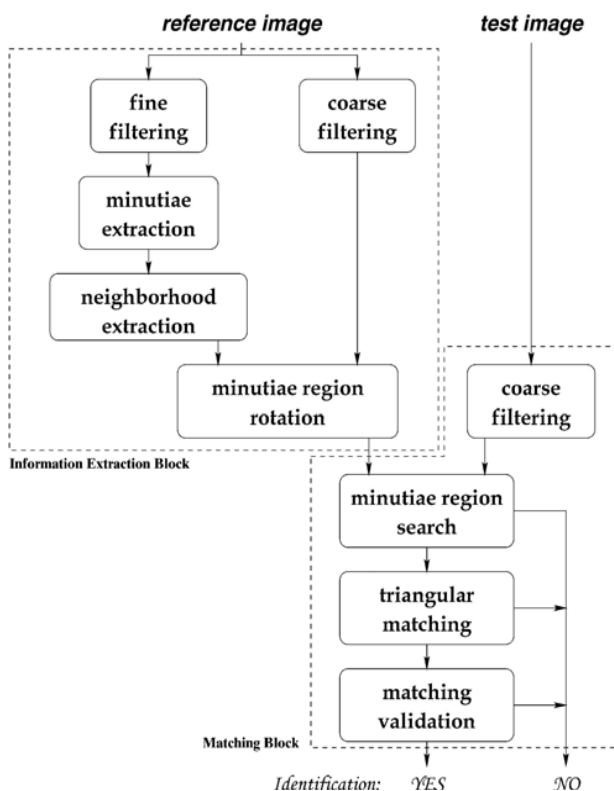

Fig. 2- Flow-chart of the identification system.

CONCLUSION

A fingerprint verification system has been designed and implemented based on two main blocks: the information extraction block and the matching block. The first block is used to extract the information from reference images offline. The second block is used in the matching phase online. The minutiae correspondences are found using a triangular matching algorithm and the final verification uses Dynamic Time Warping. Triangular matching is fast and overcomes the relative nonlinear deformation present in the fingerprint image pairs. In fact, triangular matching saves local regularities and compensates for global distortion. The final verification based on Dynamic Time Warping allows a

very low false positive rate to be obtained. The fingerprint matching rate and accuracy is very high, even on a difficult image database. We have proposed a new fingerprint matching algorithm based on ratios of relational distances. We extended the same concept to make the algorithm sensor – independent and also obtained satisfactory results. The proposed algorithm is able to generate a matching score when it obtains a minimum of $(N/2) + 1$ common minutia points between the base and the input image, where N is the maximum of Number of detected minutiae points in either the base or the input image. The implementation of a new minutiae-based fingerprint pattern matching algorithm has been presented. The algorithm uses the Euclidian and spatial characteristics of the minutiae and the core points to determine the similarity score for two fingerprint images. The obtained results showed the effectiveness of the algorithm at distinguishing fingerprints from different sources with average FAR of 0%. The algorithm yielded different FRR values for the used datasets due to unequal corruption and noise levels. The first dataset is mostly affected with FRR values of 10.23% while the third dataset is least affected with FRR value of 5.51%. A comparison of the obtained results with what obtained for some recently formulated algorithms over the same datasets revealed superior performance for the proposed algorithm. The implication of this superiority is that the new algorithm is more suitable for reducing the error rates and improving on the performances of the existing AFIS. Future research direction aims at the optimization of the proposed algorithm for further reduction in the FRR values and the computation times.

REFERENCES

- [1] Fingerprint Verification Competition, August 2000, organized by Biometric Systems Lab (University of Bologna), U.S National Biometric Test Center (SJSU), and Pattern Matching and Image Processing Laboratory (MSU).
- [2] A.Ross, A.K.Jain, "Biometric Sensor Interoperability – A case study in Fingerprints," International ECCV workshop on Biometric Authentication (BioAW), Prague, Czech Republic, LNCS vol. 3087, pp. 134-145, May 2004.
- [3] A.K.Jain, S.Prabhakar, L.Hong, S.Pankanti, "Filterbank based Fingerprint Matching," IEEE Transactions on Image Processing, vol. 9, no. 5, May 2000.
- [4] A.K.Jain, A.Ross, S.Prabhakar, "Fingerprint Matching

using Minutiae and Texture Features,” International Conference on Image Conference , vol. 3, 282 – 285, 2001.

[5] S.Gold and A.Rangarajan, “A graduated assignment algorithm for graph matching,” IEEE Transactions on Pattern Analysis and Machine Intelligence., vol. 18, no.4, pp.

[6] A.K.Hrechak and J.A.Mchugh, “Automated Fingerprint Recognition using Structural Matching,” Pattern Recognition, vol. 23, pp. 893-904, 1990.

[7] M.Eshera and K.S.Fu, “A Similarity Measure between Attributed Relational Graphs for Image Analysis,” in Proceedings of the 7th International Conference on Pattern Recognition, Montreal, P.Q., Canada, July 30 – Aug 3 1984.

[8] N.K Ratha, V.D Pundit, R.M Bolle, V. Vaish, “Robust Fingerprint Authentication Using Local Structural Similarity,” Workshop on Applications of Computer Vision, 29 – 34, '00.

[9] A.Ranade & A.Rosenfeld, “Point Pattern Matching by Relaxation,” Pattern Recog., vol, no:12,2; 269-275, 1993.

[10] J.Ton and A.K.Jain, “Registering landsat images by point matching,” IEEE Transactions on GeoSci. Remote Sensing, vol.27, pp. 642-651, May 1989.

CSE-18 Internet of Robotics Things

MsAshwini B. Lokhande, MrRahul Gaikwad

1Ashwinilokhande

GF'S Godavari Engineering College India,425001

*² MrRahul Gaikwad ,Assistant Professor,
gaikwad005@gmail.com*

GF'S Godavari Engineering College India,425001

Abstarct:

Day to day The Internet of Things (IoT) concept is evolving rapidly and influencing new developments in various application domains, such as the Internet of Mobile Things (IoMT), Autonomous Internet of Things (A-IoT), Autonomous System of Things (ASoT), Internet of Autonomous Things (IoAT), Internet of Things Clouds (IoT-C) and the Internet of Robotic Things (IoRT) etc. are progressing/advancing by using IoT technology. This IoT paper focus on the IoRT concept, technologies, architectures and applications and to provide a comprehensive coverage of future challenges, developments and applications.

Keywords: Internet of Robotic Things
, artificial intelligence, machine learning, IoT platforms

Introdcution

Internet of Robotic Things Concept

Robotics systems traditionally provide the programmable dimension to machines designed to be involved in labour intensive and repetitive work, as well as a rich set of technologies to make these machines sense their environment and act upon it, while artificial intelligence and machine learning allow/empower these machines to function using decision making and learning

algorithms instead of programming. The combination of these scientific disciplines

opens the developments of autonomous programmable systems, combining robotics and machine learning for designing robotic systems to be autonomous.

The IoT technologies and applications are bringing fundamental changes in individuals' and society's view of how technology and business work in the world.

Citizen centric IoT open environments require tackling new technological trends and challenges. In this context, the future developments where IoT infrastructure and services intersect with robotic and autonomous system technologies to deliver advanced functionality, along with novel applications, and new business models and investment opportunities, requires new IoT architectures, concepts and tools to be integrated into the open IoT platforms design and development.

The concept of IoRT goes beyond networked and collaborative/cloud robotics and integrates heterogenous intelligent devices into a distributed architecture of platforms operating both in the cloud and at the edge. IoRT addresses the many ways IoT today technologies and robotic "devices" convergence to provide advanced robotic capabilities, enabling aggregated IoT functionality along with novel applications, and by extension, new business, and investment opportunities not only in industrial domains but in almost every sector where robotic assistance and IoT technology and applications can be imagined (home, city, buildings, infrastructures, health, etc.).

At the technology side, the proliferation of multi-radio access technology to connect intelligent devices at the edge has generated heterogeneous mobile networks that need complex configuration, management and maintenance to cope with the robotic things. The artificial intelligence (AI) techniques enable IoT robotic cognitive systems to be integrated with IoT applications almost seamlessly for creating optimized solutions and for particular applications. Cognitive IoT technologies allows embedding intelligence into systems and processes, allowing businesses to increase efficiency, find new business opportunities, and to anticipate risks and threats thus IoRT systems are better prepare to address the multiple requirements in the expected more IoT complex environment as it is depicted in

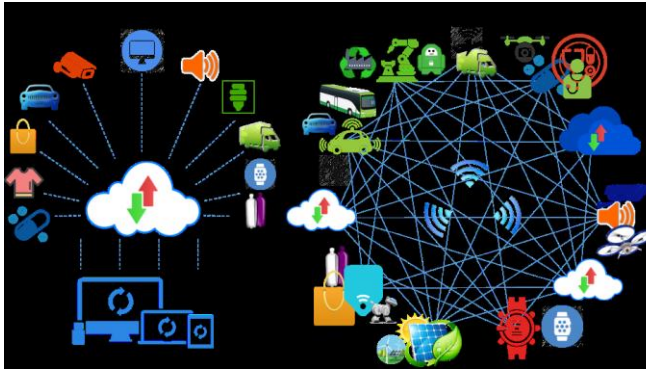

Figure 1 From a centralised cloud to distributed edge IoT platforms and applications

The combination of advanced sensing/actuating, communication, local and distributed processing, take the original vision for the IoT to a wholly different level, and one that opens completely new classes of opportunities for IoT and robotics solution providers, as well as users of their products. The concept enables baseline characteristics that can be summarized as follow:

- Define and describe the characteristics of robotics technologies that distinguish them as a separate, unique class of IoT objects, and one that differs considerably from the common understanding of IoT edge nodes as simple, passive devices.
- Reveal how the key features of robotics technology, namely movement, mobility, manipulation, intelligence and autonomy, are enhanced by the IoT paradigm, and how, in turn the IoT is augmented by robotic "objects" as "intelligent" edge devices.
- Illustrate how IoT and robotics technologies combine to provide for ambient sensing, ambient intelligence and ambient localization, which can be utilised by new classes of applications to deliver value.

Components of IOTr

1. Sensor and actuators

The two baseline technologies in IoT and robotics that are well defined and identified are sensors devices and actuators, both are always crucial components for implemented IoRT systems both with well-defined interfaces (e.g. for Identification or a Reaction) and for offering these functionalities to the IoRT platform via interaction components. Different from the IoT Sensors and Actuators compose the useful functionality in and out of the IoRT building blocks. Robotic Interaction Services (RoIS) defines also the use of external of the building block and abstracts the hardware in the service robot and the Human-Robot interaction (HRI) functions

provided by the robot. Calling each of the HRI functions provided by a robotic system such as a service robot or an intelligent sensing system a "functional implementation", a robotic system can be expressed as a set of one or more functional sensor and actuator services implementations. These functional implementations (e.g. face recognition, wheel control) are usually provided in a form that is dependent on robot hardware such as sensors and actuators, examples of these sensors and actuators services are Radar, Lidar, Camera, Microphones, etc. HRI components (e.g. person detection, person identification) are logical functional elements, realized through physical units such as sensors placed on the robot and/or in the environment. The interesting part of this standard is that it allows to build applications that can be deployed on both gateways and devices, yet it is mainly focusing on HRI scenarios.

Robotic things inherit the potential for varied and complex sensing and actuation from the long tradition of robotics. From the sensing side, robotic science and technology provides methods and algorithms to use both simple and sophisticated sensors, including inertial sensors (accelerometer, compass, gyro), ranging sensors (sonar, radar, LIDAR - Light Detection and Ranging), 3D sensors (3D laser or RGBD camera), as well more common sensors like cameras, microphones and force sensors Mobile robots or multiple robots can collect sensor data from multiple pose and/or at multiple times, and techniques exist to combine these data in a coherent picture of the environment and of its evolution in time From the actuation side, the ability to modify the physical environment is arguably the most unique aspect of robotic things. Actuation can take a wide range of forms, from to operation of simple devices like an automatic door to the transportation of goods and people and to the manipulation of objects. An impressive range of techniques for actuation have been developed in the robotics field, including techniques for autonomous planning and execution of actions by single or multiple robots

2. Communication technologies

Communication protocols are the backbone of IoRT systems and enable network connectivity and integration to applications. Different communication protocols are used by the edge devices and robotic things to exchange data over the network by defining the data exchange formats, data encoding, addressing schemes for devices and routing of packets from source to destination. The protocols used are 802.11 – Wi-Fi which includes different Wireless Local Area Network (WLAN) communication standards (i.e. 802.11a that operates in the 5 GHz band, 802.11b and 802.11g

operate in the 2.4 GHz band, 802.11n operates in the 2.4/5 GHz bands, 802.11ac operates in the 5 GHz band and 802.11ad operates in the 60 GHz band). The standards provide data rates from 1 Mb/s to 6.75 Gb/s and communication range in the order of 20 m (indoor) to 100 m (outdoor).

The 802.15.4 – LR-WPAN IEEE 802.15.4 is a set of Low-Rate Wireless Personal Area Networks (LR-WPAN) standards based on the specifications for high level communications protocols such as ZigBee. LR-WPAN standards provide data rates from 40 Kb/s to 250 Kb/s. The standards provide low-cost and low-speed communication to power constrained devices and operate at 868/915 MHz and 2.4 GHz frequencies at low and high data rates, respectively.

3.Processing and sensors/actuators data fusion

Connected robotic things can share their sensor data, fuse them, and reason collectively about them. The mobility and autonomy capabilities of robotic brings the problem of sensor fusion in IoT platforms to an entirely new level of complexity, and adds entirely new possibilities. Complexity is increased because of the great amount and variety of sensor data that robotic things can provide, and because the location of the sensing devices is not fixed and often is not know with certainty. New possibilities are enabled because of the ability of robotic things to autonomously move to specific locations to collect specific sensory input, based on the analysis of the currently available data and of the modelling and reasoning goals. The field of robotics has developed a wide array of technologies for multi-robot sensor fusion as well as for active and goal-directed perception These techniques would enable IoRT systems to dynamically and proactively collect wide ranges of data from the physical environment, and to interpret them in semantically meaningful ways.

4.Environments, objects, things modelling and dynamic mapping

Robotic things need to maintain an internal model of their physical environment and of their own position within it. The model must be continuously updated to reflect the dynamicity of the environment. The problem of creating and maintaining this model while the position of the robots are changing is known as SLAM, for “simultaneous localization and map building”, and it has been an active area of research in robotics for the past 20 years Techniques for metric 2D SLAM are now mature, and the field of robotics is now focusing on

extending these techniques to build 3D maps temporal dynamic maps and semantic maps The latter are of special interest to IoRT systems, since they enrich purely metric information with semantic information about the objects and location in the environment, including their functionalities, affordances and relations.

5.Virtual and augmented reality

Robot-assisted surgery systems are applications that are integrating virtual reality (VR) and augmented reality (AR) technology in the operating room. Live and virtual imaging featured on robot-assisted user interfaces assist surgeon's manipulation of robotic instruments and represent an open platform for the addition of VR and AR capabilities. Live surgical imaging is used to enhance on robot-assisted surgery systems through image injection or the superimposition of location-specific objects. The application of VR/AR technology in robot-assisted surgery is motion tracking of robotic instruments within an interactive model of patient anatomy displayed on a console screen.

The techniques and technology can be extended to IoRT applications with fleets of robots using VR/AR for learning, navigation and supporting functions.

6.Voice recognition, voice control

In this context, voice recognition and voice control requires robust methods for eliminating the noise by using information on the robot's own motions and postures, because a type of motion and gesture produces almost the same pattern of noise every time. The quality of the microphone is important for automatic speech recognition in order to reduce the pickup of ambient noise. The voice recognition control system for robots can robustly recognize voice by adults and children in noisy environments, where voice is captured using wireless microphones. To suppress interference and noise and to attenuate reverberation, the implementation uses a multi-channel system consisting of an outlier-robust generalized side-lobe canceller technique and a feature-space noise suppression criteria .

IoRT Platforms Architecture

The IoRT applications require holistic multi-layer, multi-dimensional architectural concepts for open IoT platforms integrating evolving sensing, actuating, energy harvesting, networking and interface technologies. This includes end-to-end security in

distributed, heterogeneous, dynamic IoT environments by using integrated components for identification, authentication, data protection and prevention against cyber-attacks at the device and system levels, and can help ensure a consistent approach to IoT standardisation processes.

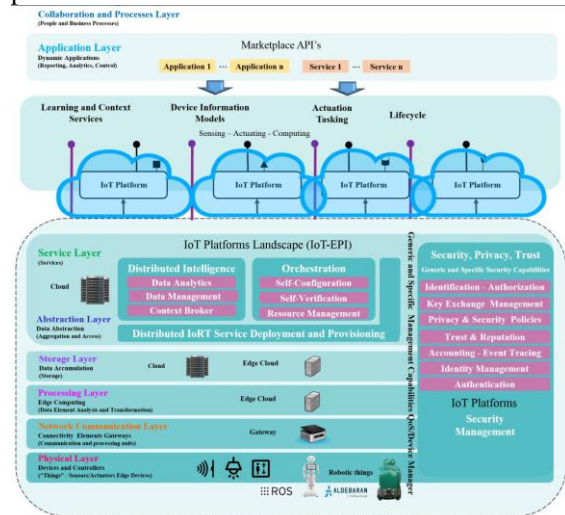

In this context, the IoT platforms need to integrate new components in the different IoT architecture layers to address the challenges for connectivity and intelligence, actuation and control features, linkage to modular and ad-hoc cloud services, data analytics and open APIs and semantic interoperability across use cases and conflict resolution by addressing object identity management, discovery services, virtualisation of objects, devices and infrastructures and trusted IoT approaches.

The IoT platforms architectures allow robotic things, local embedded and/or distributed intelligence, and smart networks to interact and exhibit smart behaviour and ultimately create open and sustainable marketplaces for large-scale complex and heterogeneous IoT applications and services. Due to the heterogeneity of the applications, devices and stakeholders IoT platforms generic architectures need to be independent of any specific application domains, which refer to the areas of knowledge or activity applied for one specific economic, commercial, social or administrative scope. The architectural concept builds on the common requirements based on use cases of the IoT and the IoT stakeholders, considering key areas from a requirement perspective combined with representative use cases of the IoT that are abstracted from application domains. The IoT developments in the last few years have generated multiple architectures, standards and IoT platforms and created a highly fragmented IoT landscape creating technological silos and solutions that are not interoperable with other IoT platforms and

applications. In order to overcome the fragmentation of vertically-oriented closed systems

architectures and application areas and move towards open systems and platforms that support multiple applications, there is a need for enhancing the architecture of open IoT platforms by adding a distributed topology and integrating new components for integrating evolving sensing, actuating, energy harvesting, networking and interface technologies. The key technological shift is to provide tools and methods for implementing components and mechanisms in different architectural layers that operates across multiple IoT architectures, platforms and applications contexts and add functionalities for actuation and smart behaviour. One solution as presented in the layered architecture concept in Figure 4.8 is that the services and applications are running on top of a specific architectural layer and provide higher-level functionalities such as e.g. data filtering and complex event management and processing that allow the services of existing IoT platforms to be integrated. This concept allows solution providers to use, share, reuse the data streams and perform analytics on shared data increasing the value added of IoT applications. The IoT applications using this approach integrate data and services among different IoT platforms and between different applications, using shared infrastructure and common standards and reducing the cost for deployment and maintenance. Application developers are able to reuse their applications in different applications, across the IoT ecosystem and greatly reducing development effort and time.

IoRT application

Drones and robots market segmentation

(Source: Sensors for Drones and Robots: Market Opportunities and Technology Revolution, March 2016, Yale Développement)

	Flying	Swimming	4+ Legged	2 Legged	4x Wheeled	2x Wheeled	Arms	Head
Defense								
Industry								
Security								
Medical								
Transport								
Commercial								
Consumer								

Research interest in service robotics for assistance and wellbeing has grown during the last few decades, particularly as consequence of demographic changes.

Maintaining a healthy lifestyle and trying to achieve a state of well-being helps to improve the life conditions and increase its durability. Service robotics could focus on early diagnosis and detection of risks, to develop prevention programs. Thus, it is possible to use robots to perform physical activity at home, or planning a proper nutrition program, based on the user's needs. Personal wellbeing management robots can provide services also for people who are alone, or live isolated from families. These robots can both detect physiological parameters and transmit them to the doctor in real time and to interpret the emotional state of the user and accordingly interact. Figure illustrate the evolution of robots in different application areas presented as report from Yole Development in 2016

Conclusion: IoT has features of reconnect with different entities like apps, devices and people interaction, which gives the better solution for many application domains. Combination of Robotics, IoT and Artificial Intelligence results in robots with higher quality capability to perform more complex tasks, autonomously or cooperating with humans. With IoT platform, multiple robots can get easily interconnected between them and with objects and humans, facilitating the capability to transfer data with them without human to computer or humans to humans interaction

References

1. O. Vermesan and P. Friess (Eds.). *Internet of Robotic Things - Converging Sensing/Actuating, Hypoconnectivity, Artificial Intelligence and IoT Platforms*
2. . O. Vermesan and P. Friess (Eds.). *Digitising the Industry Internet of Things Connecting the Physical, Digital and Virtual Worlds, ISBN: 978-87-93379-81-7, River Publishers, Gistrup, 2016*
3. J. Wan, S. Tang, H. Yan, D. Li, S. Wang, and A. V. Vasilakos, "Cloud robotics: Current status and open issues," *IEEE Access*, vol. 4, pp. 2797–2807, 2016.
4. L. Riazuelo et al., "RoboEarth semantic mapping: A cloud enabled knowledge-based approach," *IEEE Trans. Autom. Sci. Eng.*, vol. 12, no. 2, pp. 432–443, Apr. 2015.
5. G. Hu, W. P. Tay, and Y. Wen, "Cloud robotics: Architecture, challenges and applications," *IEEE Netw.*, vol. 26, no. 3, pp. 21–28, May/Jun. 2012

6. *Robotics 2020 Multi-Annual Roadmap (MAR)*, online at https://www.eu-robotics.net/cms/upload/downloads/ppp-documents/Multi-Annual_Roadmap2020_ICT-24_Rev_B_full.pdf
7. *Yole Development Report, "Sensors for drones and robots: market opportunities and technology revolution 2016" Report by YoleDeveloppement, February 2016 From Technologies to Market Sensors for Drones & Robots 2016 report sample*

CSE-19 Computer and Network Security

Prof. Vasanti U. Mahajan¹, Prof. Pooja S. Dani², Prof. Rais Khan³

^{1,2} Assit Prof., ³ Asstt. Prof.

^{1,2} Dept of Computer Science, Annasaheb G. D. Bendale Mahila Mahavidyalaya, Jalgaon, Maharashtra, India

³ Computer Engg. dept, GF's Godavari College of Engineering, Jalgaon, Maharashtra, India

¹ vasantimahajan94@gmail.com, ³ khanrais.khan42@gmail.com

Abstract:

Computer security is the continuing effort to protect electronics data and computer system from unwanted instruction. The goal of computer security is to protect electronic information both in transit and at rest. Our aim with this research is to check the awareness level of cybercrime and security majors and to suggest necessary steps which can really be helpful in making the environment secure, robust.

It is critical we consider what implications current and future technologies have for security and privacy. Requirements for further research, we explore how security and privacy might involve over the next decade. Computer network security is the first line of defense to accomplish information assurance. The computer network is at risk without a well-designed and flawless implemented network security policy. The main problem is that network administrators are not able to verify the network security policy. Although further research has been carried out, it mainly concerns small specific parts of the overall system

Introduction:

Network Security is the most vital component in information security because it is responsible for securing all information passed through networked computers. Network Security refers to all hardware and software functions, characteristics, features, operational procedures, accountability, measures, access control, and administrative and management policy required to provide an acceptable level of protection for Hardware and Software, and information in a network.

Network security problems can be divided roughly into four closely intertwined areas: secrecy, authentication, non repudiation, and integrity control. Secrecy, also called confidentiality, has to do with keeping information out of the hands of unauthorized users. This is what usually comes to mind when people

think about network security. Authentication deals with determining whom you are talking to before revealing sensitive information or entering into a business deal. Non repudiation deals with signatures.

Network security starts with authorization, commonly with a username and a password. Network security consists of the provisions and policies adopted by a network administrator to prevent and monitor unauthorized access, modification in system, misuse, or denial of a computer network and network-accessible resources. Basically network security involves the authorization of access to data in a network, which is controlled by the network admin. It has become more important to personal computer users, and organizations. If this authorized, a firewall forces to access policies such as what services are allowed to be accessed for network users. So that to prevent unauthorized access to system, this component may fail to check potentially harmful content such as computer worms or Trojans being transmitted over the network. Anti-virus software or an intrusion detection system (IDS) helps detect the malware. Today anomaly may also monitor the network like wire shark traffic and may be logged for audit purposes and for later on high-level analysis in system. Communication between two hosts using a network may be uses encryption to maintain privacy policy.

Network security:

System and Network Technology is a key technology for a wide variety of applications. It is a critical requirement in current situation networks, there is a significant lack of security methods that can be easily implemented. There exists a "communication gap" between the developers of security technology and developers of networks. Network design is a developed process that is depends on the Open Systems Interface (OSI) model. The OSI model has several advantages

when designing network security. It offers modularity, ease-of-use, flexibility, and standardization of protocols.

1. Access: - Authorized users are provided the means to communicate to and from a particular network
2. Confidentiality: - It means that the non-authenticated party does not examine the data
3. Integrity: - It is an guarantee that the data which is received by the receiver has not been change or modified after the send by the sender.
4. Non repudiation: - Ensure the user does not refute that he used the network.

Types of Attack:

1. Common Internet Attack Methods

Common internet attacks methods are broken down into categories. Some attacks gain system knowledge or personal information, such as eavesdropping and phishing. Attacks can also interfere with the system's intended function, such as viruses, worms and Trojans. The other form of attack is when the system's resources are consumes uselessly, these can be caused by Denial of Service (DoS) attack. Other forms of network intrusions also exist, such as land attacks, scurf attacks, and teardrop attacks. These attacks are not as well known as DoS attacks.

1.1 Eavesdropping

Interception of communications by an unauthorized party is called eavesdropping. Passive eaves dropping is when the person only secretly listens to the networked messages. On the other hand, active eavesdropping is when the intruder listens and inserts something into the communication stream. This can lead to the messages being distorted. Sensitive information can be stolen this way.

1.2 Viruses

Viruses are self-replication programs that use files to infect and propagate. Once a file is opened, the virus will activate within the system.

1.3 Worms

A worm is similar to a virus because they both are self-replicating, but the worm does not require a file to allow it to propagate. There are two main types of worms, mass-mailing worms and Network-aware worms. Mass mailing worms use email as a means to infect other computers. Network-aware worms are a major problem for the Internet. A network-aware worm selects a target and once the worm accesses the target host, it can infect it by means of a Trojan or otherwise.

1.4 Trojans

Trojans appear to be benign programs to the user, but will actually have some malicious purpose. Trojans usually carry some payload such as a virus.

1.5 Phishing

Phishing is an attempt to obtain confidential information from an individual, group, or Organization. Phisher strick users into disclosing personal data, such as credit card numbers, online bank credentials, and other sensitive information.

1.6 IP Spoofing Attacks

Spoofing means to have the address of the Computer mirror the address of a trusted computer in order to gain access to other computers. The identity of the intruder is hidden by different means making detection and prevention difficult. With the current IP protocol technology, IP- spoofed packets cannot be eliminated.

1.7 Denial of Service

Denial of Service is an attack when the system receiving too many requests cannot return communication with the requestors. The system then consumes resources waiting for the handshake to complete. Eventually, the system cannot respond to any more requests rendering it without service.

2. Technology for Internet Security

Internet threats will continue to be a major issue in the global world as long as information is accessible and transferred across the Internet. Different defense and detection mechanisms were developed to deal with these attacks.

2.1 Cryptographic systems

Cryptography is a useful and widely used tool in security engineering today. It involved the use of codes and ciphers to transform information into unintelligible data.

2.2 Firewall

A firewall is a typical border control mechanism or perimeter defense. The purpose of a firewall is to block traffic from the outside, but it could also be used to block traffic from the inside. A firewall is the front line defense mechanism against intruders. It is a system designed to prevent unauthorized access to or from a private network. Firewalls can be implemented in both hardware and software, or a combination of both.

2.3 Intrusion Detection Systems

An Intrusion Detection System (IDS) is an additional protection measure that helps ward off computer intrusions. IDS systems can be software and hardware devices used to detect an attack. Some IDS systems just monitor and alert of an attack, whereas others try to block the attack.

2.4 Anti -Malware Software and scanners

Viruses, worms and Trojan horses are all examples of malicious software, or Malware for short. Special so-called anti-Malware tools are used to detect them and cure an infected system.

2.5 Secure Socket Layer (SSL)

The Secure Socket Layer (SSL) is a suite of protocols that is a standard way to achieve a good level of security between a web browser and a website. SSL is designed to create a secure channel, or tunnel, between a web browser and the web server, so that any information exchanged is protected within the secured tunnel. SSL provides authentication of clients to server through the use of certificates.

3. Security Issues of IP Protocol IPv6

From a security point of view, IPv6 is a considerable advancement over the IPv4 internet protocol. Despite the IPv6's great security mechanisms, it still continues to be vulnerable to threats. The possible security problems emerge due to the following:

1. Header manipulation issues
2. Flooding issues
3. Mobility issue

Differentiating Data Security and Network Security

Data security is the aspect of security that allows a client's data to be transformed into unintelligible data for transmission. Strong cryptography in the past can be easily broken today. Cryptographic methods have to continue to advance due to the advancement of the hackers as well. When transferring cipher text over a network, it is helpful to have a secure network. A secure network will also prevent someone from inserting unauthorized messages into the network. Therefore, hard ciphers are needed as well as attack hard networks.

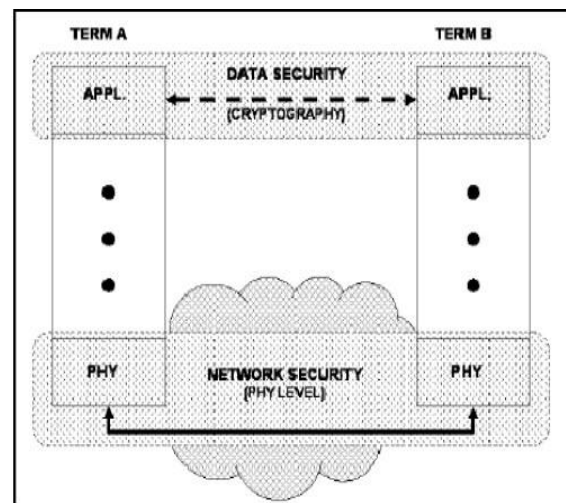

Figure 1: Based on the OSI model, data security and network security have a different security function.

The relationship of network security and data security to the OSI model is shown in Figure 1. It can be seen that the cryptography occurs at the application layer; therefore the application writers are aware of its existence. Layers above the physical layers are also used to

accomplish the network security required. Authentication is performed on a layer above the physical layer.

ITY IN DIFFERENT NETWORKS :

The businesses today use combinations of firewalls, encryption, and authentication mechanisms to create "intranets" that are connected to the internet but protected from it at the same time. Intranet is a private computer network that uses internet protocols. Intranets differ from "Extranets" in that the former are generally restricted to employees of the organization while extranets can generally be accessed by customers, suppliers, or other approved parties. When such access is provided it is usually through a gateway with a firewall, along with user authentication, encryption of messages, and often makes use of virtual private networks (VPNs). To keep the networks open, with these safeguards:

1. Firewalls that detect and report intrusion attempts
2. Sophisticated virus checking at the firewall
3. Enforced rules for employee opening of e-mail attachments
4. Encryption for all connections and data transfers
5. Authentication by synchronized, timed passwords or security certificates

VPN is a private network that uses a public network (usually the Internet) to connect remote sites or users together. Figure 3 is a graphical representation of an organization and VPN network.

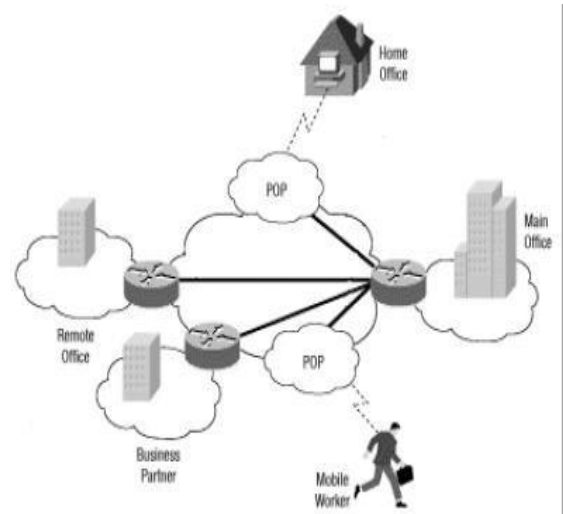

Figure 3: A typical VPN might have a main LAN at the corporate headquarters of a company, other LANs at remote offices or facilities and individual users connecting from out in the field.

Hardware Developments

Hardware developments are not developing rapidly. Biometric systems and smart cards are the only new hardware technologies that are widely impacting security. The most obvious use of biometrics for network security is for secure workstation logons for a workstation connected to a network. Each workstation requires some software support for biometric identification of the user as well as, depending on the biometric being used, some hardware device. The main use of Biometric network security will be to replace the current password system. Passwords have to be changed every few months and people forget their password or lock themselves out of the system by incorrectly entering their password repeatedly. Biometrics can replace this security identification method. Smart cards are usually a credit-card-sized digital electronic media. Smart cards can be used for everything from logging in to the network to providing secure Web communications and secure e-mail transactions. Smart cards require anyone who is using them to enter a personal identification number (PIN) before they'll be granted any level of access into the system. The PIN is similar to the PIN used by ATM machines. The PIN is verified from inside the smart

card. The smart card is cost-effective but not as secure as the biometric identification devices.

Advantage

- Protect system against viruses and other unwanted programs.
- Gives privacy to users.
- Protect the computer from being hacked.
- Protection against data from theft.

Disadvantages:

- Makes Firewall can be difficult to configure correctly.
- The system slower than before.
- Need to keep updating the new software in order to keep security up to date.
- Could be costly for average user.

Conclusion:

Network Security is the most vital component in information security because it is responsible for securing all information passed through networked computers. Network security consists of the provisions made in an underlying computer network infrastructure, policies adopted by the network administrator to protect the network and the network-accessible resources from unauthorized access, and consistent and continuous monitoring and measurement of its effectiveness (or lack) combined together. We have studied various cryptographic techniques to increase the security of network. Cryptography, together with suitable communication protocols, can provide a high degree of protection in digital communications against intruder attacks as far as the communication between two different computers is concerned. The security technology is mostly software based, but many common hardware devices are used. The current development in network security is not very impressive. The embedded security of the new internet protocol such as firewalls, intrusion detection, and authentication mechanisms will prove effective in guarding intellectual property for the near future. The network security field may have to evolve more rapidly to deal with the threats further in the future.

References

1. NehaKhandelwal, Prabhakar.M. Kuldeep Sharma, "An Overview Of security Problems in MANET".

2. Anupam Joshi and Wenjia Li. "Security Issues in Mobile Ad Hoc Networks- A Survey".
3. Ali Ghaffari, "Vulnerability and Security of Mobile Ad hoc Networks".
4. DENNING, D., and DENNING, P.J.: 'Data security', *ACM Comput. Surveys*, 1979, 11, pp. 227-250
5. A Role-Based Trusted Network Provides Pervasive Security and Compliance - interview with JayshreeUllal, senior VP of Cisco.
6. Dave Dittrich, Network monitoring/Intrusion Detection Systems (IDS), University of Washington.
7. Dowd, P.W.; McHenry, J.T., "Network security: it's time to take it Seriously," *Computer*, vol.31, no.9, pp.24- 28, Sep 1998
8. Kartalopoulos, S. V., "Differentiating DataSecurity and Network Security," *Communications*, 2008. ICC '08. IEEE International Conference on, pp.1469-1473, 19-23 May 2008
9. "Security Overview," www.redhat.com/docs/manuals/enterprise/RHEL-4-Manual/security-guide/ch-sgs-ov.html.
10. Molva, R., InstitutEurecom, "Internet SecurityArchitecture," in *Computer Networks & ISDN Systems Journal*, vol. 31, pp. 787-804, April 1999
11. Sotillo, S., East Carolina University, "IPv6 security issues," August 2006, www.infosecwriters.com/text_resources/pdf/IPv6_Sotillo.pdf.
12. AndressJ., "IPv6: the next internet protocol," April 2005, www.usenix.com/publications/login/2005-04/pdfs/andress0504.pdf.

National Conference on Current Trends in Engineering, Science and Technology (NACCTEST- 2018)
 Organized by GF's Godavari College of Engineering, Jalgaon
International Journal of Innovations in Engineering and Science, Special Conference Issue, 2018
 www.ijies.net

Reliability of Mathematical model in Cupola Furnace

Hemant R. Bhagat ¹, Dr. V. G. Arajpure ²,

¹ Research scholar

B.D.C.O.Engg. Wardha,(M.S), India

² Principal & Research Guide

Godavari College of Engineering, Jalgaon, India

¹Email:- hrbhagatpatil@gmail.com

Abstract – A subject that is so important to many decisions in this world could hardly escape quantitative analysis. The name “reliability” is given to the field of study that attempts to assign numbers to the propensity of systems to fail. In a more restrictive sense, the term “reliability” is defined to be the probability that a system performs its mission successfully. This presents an approach to reliability of models. Error frequency distribution for developed models with graphical representation. These graphs were compared with probability density function graphs of commonly used life distributions.

Reliability of the model can be established by using

Reliability % = 100 - % Mean Error

Keywords- Mathematical model, Cupola furnace, field data.

INTRODUCTION

This represents an approach to reliability of models. Error frequency distribution graphs were plotted for developed models. These graphs were compared with probability density function graphs of commonly used life distributions.

In statistical analysis frequency distribution is most generalized case. Many statistical distributions are used to model various reliability parameters. The particular distribution used depends on the nature of the data being analyzed. Model reliability approximation is executed by comparing error frequency graphs of various mathematical models with probability density function graphs of commonly used life distribution.

This also presents a statistical method that explains how much of the variability of a factor can be caused or explained by its relationship to another factor. This is achieved through the trend analysis by the method of Coefficient of determination. The approach of R2-Co-efficient of Determination is used to analyze the behavior of mathematical models and clubbed models. The calculation for the reliability and the value of R2-Co-efficient of Determination is done for five response variables i.e. Π01 toΠ012and the proper comparisons are made to analyze the best suit for the reliability and the value of R2-Co-efficient.

Life distribution

Life distribution is the basic tool of reliability engineer; which may also be called as failure distribution. They can be either a combination of smaller distributions of different failure mechanism or a single distribution representing single failure mechanism. Life distribution can have any shape, but some standard forms have become commonly used over the years. Commonly used life distributions are: normal, lognormal, exponential and Weibull.

The normal distribution

The normal distribution is more often used to model repair many times, although it is also used to model reliability. In this application, the normal distribution is most applicable to simple maintenance tasks that consistently require a fixed amount of time to complete with little variation. The probability density function of the normal distribution is often called the bell curve

because of its distinctive shape. Figure 1 shows the plot of the standard normal probability density function.

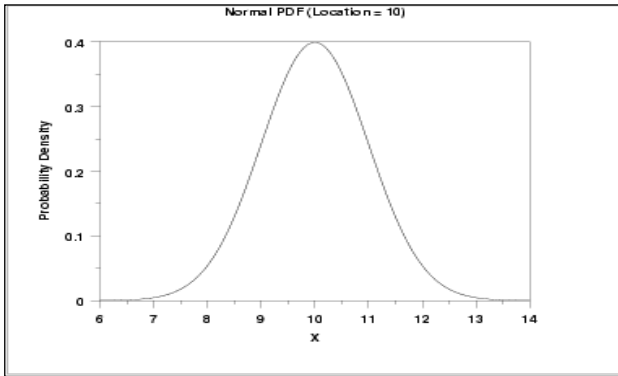

Fig. 1- Probability density function normal distribution

The lognormal distribution

It is also used to model reliability. The lognormal is applicable to maintenance tasks where the task time and frequency vary, which is often the case for complex systems and products. Unlike the mean of the normal distribution, the mean of the lognormal is not the 50th percentile of the distribution and the distribution is not symmetrical around the mean. Figure shows the plot of the standard lognormal probability density function for four values of σ .

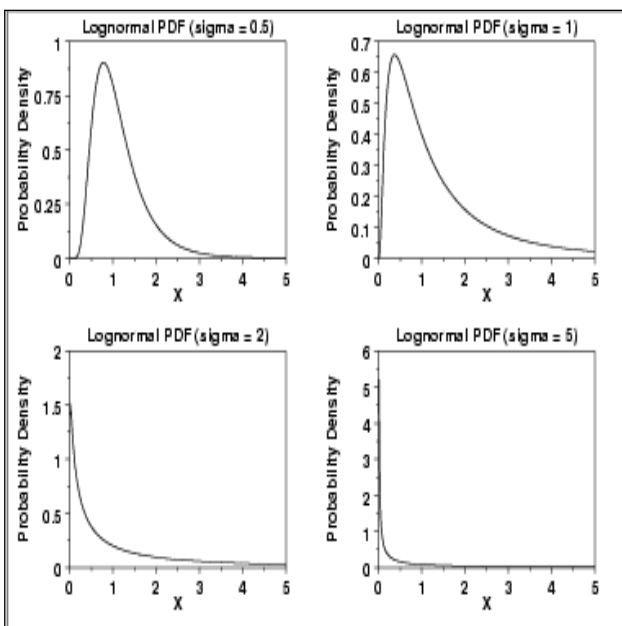

Fig. 2- Probability density function lognormal distribution

The exponential distribution

The exponential distribution is widely used to model electronic reliability failures in the operating domain that tend to exhibit a constant failure rate. To fail exponentially means that the distribution of failure times fits the exponential distribution plot as shown in probability density function. Figure 2 represents probability density function for exponential distribution.

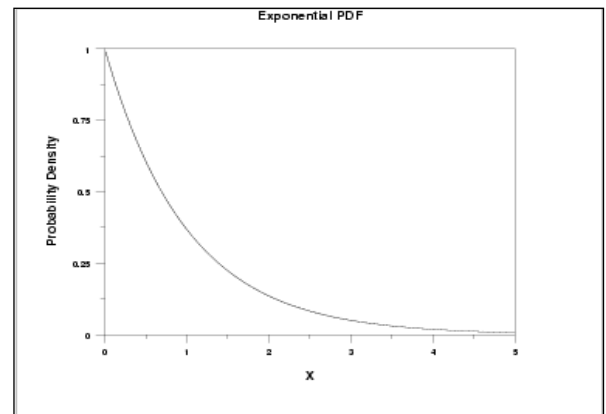

Fig. 3- Probability density function exponential distribution

The Weibull distribution

The Weibull distribution is an important distribution since it can be used to represent many different probability density functions. It has many applications. The Weibull distribution can be used to fit a wide variety of data and it models wear out. Figure 4 illustrates the plot of the Weibull probability density function.

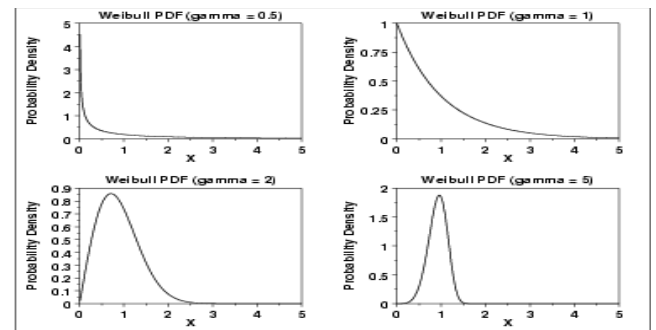

Fig. 4- Probability density function Weibull distribution

Error frequency distribution

National Conference on Current Trends in Engineering, Science and Technology (NACCTEST- 2018)
 Organized by GF's Godavari College of Engineering, Jalgaon
International Journal of Innovations in Engineering and Science, Special Conference Issue, 2018
 www.ijies.net

In our experimentation, we have two sets of values i.e. observed and computed values of all twelve dependent parameters viz. % of Carbon Equivalent: Π01, % of Carbon Content: Π02, % of Silicon Content: Π03, Slag at outlet: Π04, Wood at outlet: Π05, Pig Iron outlet: Π06, Cast Iron Scrap Outlet: Π07, Coke at outlet : Π08, Waste In front of Cupola : Π09, Number of Actual Charging required : Π010, Strength of Material : Π011, Hardness of Material : Π012. The difference of these two values provides the error. Frequencies of occurrence

of specific errors are estimated for four models of oil extrusion process as representative sample. Table shows calculations for frequency of error analysis and Reliability. All figures show graphs of % Error Frequency for all response variable models.

Tables 1:-Error frequency distribution and Reliability for all mathematical models

For Pi01			For Pi02			For Pi03			For Pi04		
%Error)fi(Frequen cy)xi(fi*x i	%Error)fi(Frequen cy)xi(fi*x i	%Error)fi(Frequen cy)xi(fi*x i	%Error)fi(Frequen cy)xi(fi*x i
0	22	0	0	23	0	0	5	0	0	4	0
1	19	19	1	18	18	1	5	5	1	1	1
2	9	18	2	8	16	2	5	10	2	3	6
4	2	8	3	1	3	3	9	27	3	4	12
7	52	45	4	1	4	4	7	28	4	6	24
			25	1	25	5	3	15	5	1	5
			35	52	66	6	4	24	6	12	72
						7	3	21	7	2	14
						8	5	40	8	5	40
						9	4	36	9	2	18
						13	1	13	10	3	30
						27	1	27	11	3	33
						85	52	246	17	1	17
									22	2	44
									29	1	29
									32	1	32
									42	1	42
									208	52	419

Mean Error	$\Sigma fi \cdot xi / x$	0.865	1.269	4.730	8.057
Reliability)100-Mean Error(99.13	98.73	95.269	91.94

National Conference on Current Trends in Engineering, Science and Technology (NACCTEST- 2018)
 Organized by GF's Godavari College of Engineering, Jalgaon
International Journal of Innovations in Engineering and Science, Special Conference Issue, 2018
 www.ijies.net

For Pi05		
%Error)fi(Frequency)xi(fi*xi
0	7	0
1	6	6
2	6	12
3	6	18
4	2	8
5	5	25
6	3	18
7	2	14
8	2	16
9	1	9
10	3	30
11	1	11
12	3	36
14	1	14
15	1	15
16	1	16
18	1	18
27	1	27
Σ	52	293

For Pi06		
%Error)fi(Frequency)xi(fi*xi
0	3	0
1	4	4
2	5	10
3	9	27
4	2	8
5	3	15
6	5	30
7	1	7
8	3	24
9	2	18
11	2	22
12	1	12
13	2	26
14	2	28
15	2	30
17	1	17
19	1	19
21	1	21
22	1	22
23	1	23
33	1	33
0	0	0
Σ	52	396

For Pi07		
%Error)fi(Frequency)xi(fi*xi
0	4	0
1	4	4
2	7	14
4	3	12
5	2	10
6	2	12
7	1	7
8	3	24
9	4	36
11	2	22
12	2	24
13	4	52
14	4	56
15	1	15
18	1	18
19	1	19
20	1	20
21	1	21
23	1	23
24	1	24
28	1	28
44	2	88
Σ	52	529

For Pi08		
%Error)fi(Frequency)xi(fi*xi
0	1	0
1	7	7
2	5	10
3	3	9
4	8	32
5	2	10
6	6	36
7	3	21
8	2	16
9	3	27
10	2	20
11	3	33
12	1	12
13	2	26
17	1	17
19	1	19
20	2	40
Σ	52	335

Mean Error	$\Sigma fi*xi/xi$	5.635
Reliability	$(100 - \text{Mean Error})$	94.37

7.615
92.384

10.173
89.826

6.442
93.557

For Pi09		
%Error)fi(Frequency)xi(fi*xi
0	3	0
1	1	1
2	2	4
3	3	9
4	1	4
5	3	15
7	2	14

For Pi010		
%Error)fi(Frequency)xi(fi*xi
0	14	0
1	7	7
2	6	12
3	5	15
4	4	16
5	4	20
6	5	30

For Pi011		
%Error)fi(Frequency)xi(fi*xi
0	4	0
1	3	3
2	2	4
3	2	6
4	6	24
5	4	20
6	5	30

For Pi012		
%Error)fi(Frequency)xi(fi*xi
0	7	0
1	10	10
2	7	14
3	8	24
4	5	20
5	7	35
6	2	12

National Conference on Current Trends in Engineering, Science and Technology (NACCTEST- 2018)
 Organized by GF's Godavari College of Engineering, Jalgaon
International Journal of Innovations in Engineering and Science, Special Conference Issue, 2018
 www.ijies.net

8	4	32	Σ	7	2	14	Σ	7	6	42	Σ	7	2	14
9	3	27		8	3	24		8	5	40		8	2	16
10	2	20		9	2	18		9	3	27		19	1	19
11	2	22		45	52	156		10	3	30		25	1	25
12	2	24						11	2	22		80	52	189
13	3	39						12	2	24				
14	2	28						13	2	26				
15	2	30						15	2	30				
16	2	32						79	1	79				
18	3	54						Σ	185	52		407		
19	2	38												
20	2	40												
21	2	42												
26	1	26												
27	1	27												
29	1	29												
33	1	33												
40	1	40												
44	1	44												
Σ	407	52	674											

Mean Error	$\frac{\sum f_i \cdot x_i}{x_i}$	12.96	3	7.82	3.634
Reliability	100 - Mean Error	87.04	97	92.173	96.365

For Pi05			For Pi06			For Pi07			For Pi08					
%Error	Frequency	f _i *x _i	%Error	Frequency	f _i *x _i	%Error	Frequency	f _i *x _i	%Error	Frequency	f _i *x _i	%Error	Frequency	f _i *x _i
0	7	0	0	3	0	0	4	0	0	1	0	0	1	0
1	6	6	1	4	4	1	4	4	1	7	7	1	7	7
2	6	12	2	5	10	2	7	14	2	5	10	2	5	10
3	6	18	3	9	27	4	3	12	3	3	9	3	3	9
4	2	8	4	2	8	5	2	10	4	8	32	4	8	32
5	5	25	5	3	15	6	2	12	5	2	10	5	2	10
6	3	18	6	5	30	7	1	7	6	6	36	6	6	36
7	2	14	7	1	7	8	3	24	7	3	21	7	3	21
8	2	16	8	3	24	9	4	36	8	2	16	8	2	16
9	1	9	9	2	18	11	2	22	9	3	27	9	3	27
10	3	30	11	2	22	12	2	24	11	2	20	10	2	20
11	1	11	12	1	12	13	4	52	11	3	33	11	3	33
12	3	36	13	2	26	14	4	56	12	1	12	12	1	12
14	1	14	14	2	28	15	1	15	13	2	26	13	2	26

National Conference on Current Trends in Engineering, Science and Technology (NACCTEST- 2018)
 Organized by GF's Godavari College of Engineering, Jalgaon
International Journal of Innovations in Engineering and Science, Special Conference Issue, 2018
 www.ijies.net

Σ	15	1	15	15	2	30	18	1	18	Σ	17	1	17
	16	1	16	17	1	17	19	1	19		19	1	19
	18	1	18	19	1	19	20	1	20		20	2	40
	27	1	27	21	1	21	21	1	21		147	52	335
	168	52	293	22	1	22	23	1	23				
				23	1	23	24	1	24				
				33	1	33	28	1	28				
				0	0	0	44	2	88				
				Σ 245	52	396	Σ 304	52	529				

Mean Error	$\Sigma fi * xi / xi$	5.6
Reliability	$(100 - \text{Mean Error})$	94.37

7.615
92.384

10.17
3
89.82
6

6.442
93.557

National Conference on Current Trends in Engineering, Science and Technology (NACCTEST- 2018)
 Organized by GF's Godavari College of Engineering, Jalgaon
 International Journal of Innovations in Engineering and Science, Special Conference Issue, 2018
 www.ijies.net

For Pi09			For Pi010			For Pi011			For Pi012		
%Error) fi(Frequen cy) xi(fi*xi	%Err or) fi(Freque ncy) xi(fi*xi	%Error) fi(Freq uenc y) xi(fi*xi	%Error) fi(Frequency) xi(fi*xi
0	3	0	0	14	0	0	4	0	0	7	0
1	1	1	1	7	7	1	3	3	1	10	10
2	2	4	2	6	12	2	2	4	2	7	14
3	3	9	3	5	15	3	2	6	3	8	24
4	1	4	4	4	16	4	6	24	4	5	20
5	3	15	5	4	20	5	4	20	5	7	35
7	2	14	6	5	30	6	5	30	6	2	12
8	4	32	7	2	14	7	6	42	7	2	14
9	3	27	8	3	24	8	5	40	8	2	16
10	2	20	9	2	18	9	3	27	19	1	19
11	2	22	45	52	156	10	3	30	25	1	25
12	2	24				11	2	22	80	52	189
13	3	39				12	2	24			
14	2	28				13	2	26			
15	2	30				15	2	30			
16	2	32				79	1	79			
18	3	54				Σ	185	52	407		
19	2	38									
20	2	40									
21	2	42									
26	1	26									
27	1	27									
29	1	29									
33	1	33									
40	1	40									
44	1	44									
Σ	407	52	674								

Mean Error	$\frac{\sum fi*xi}{xi}$	12.96	3	7.82	3.634
Reliability	100-Mean Error(87.04	97	92.173	96.365

From calculation, the value of Reliability R_i for general mathematical models are shown in table, which shows that the values of general model are more than 90%, so the model is more accurate.

National Conference on Current Trends in Engineering, Science and Technology (NACCTEST- 2018)
 Organized by GF's Godavari College of Engineering, Jalgaon
International Journal of Innovations in Engineering and Science, Special Conference Issue, 2018
 www.ijies.net

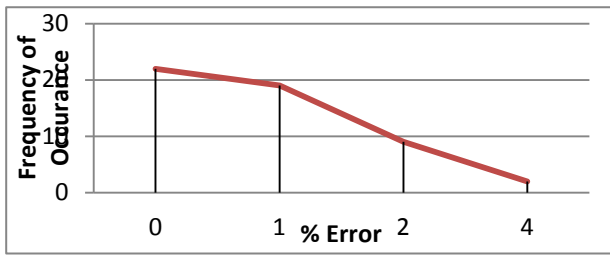

Fig. 5- % Error Frequency graph for % of Carbon Equivalent: II01

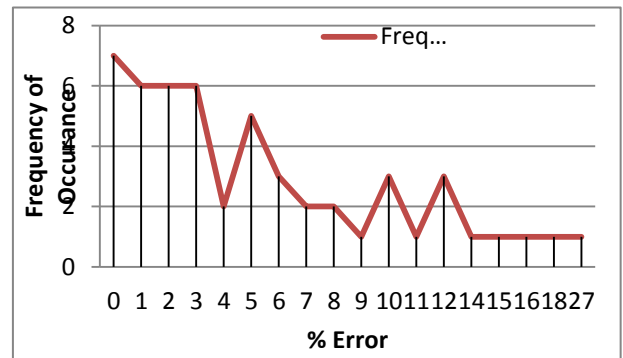

Fig. 9 -% Error Frequency graph for Wood at outlet: II05

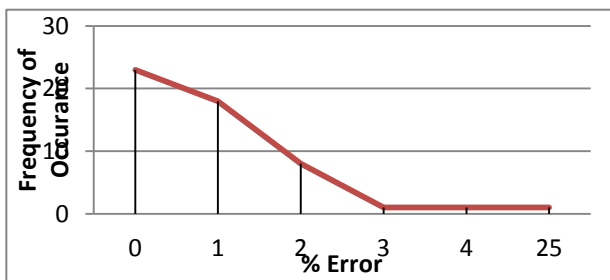

Fig. 6- % Error Frequency graph for % of Carbon Content: II02

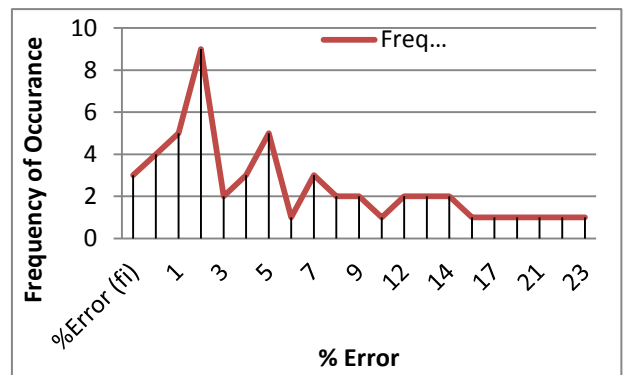

Fig. 10- % Error Frequency graph for For Pig Iron outlet: II06

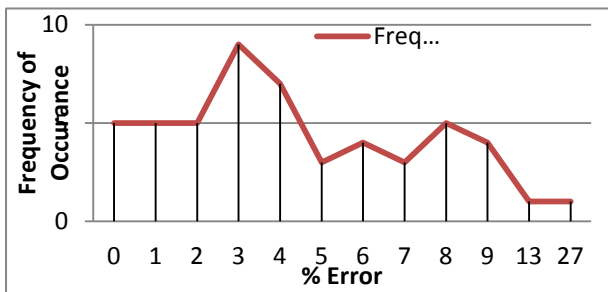

Fig. 7- % Error Frequency graph for For % of Silicon Content: II03

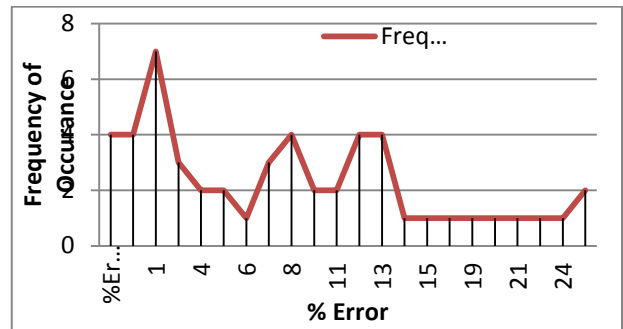

Fig. 11- % Error Frequency graph for Cast Iron Scrap Outlet: II08

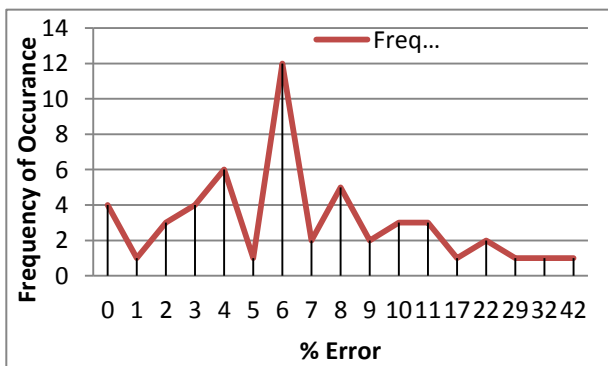

Fig. 8- % Error Frequency graph for Slag at outlet: II04

National Conference on Current Trends in Engineering, Science and Technology (NACCTEST- 2018)
 Organized by GF's Godavari College of Engineering, Jalgaon
 International Journal of Innovations in Engineering and Science, Special Conference Issue, 2018
 www.ijies.net

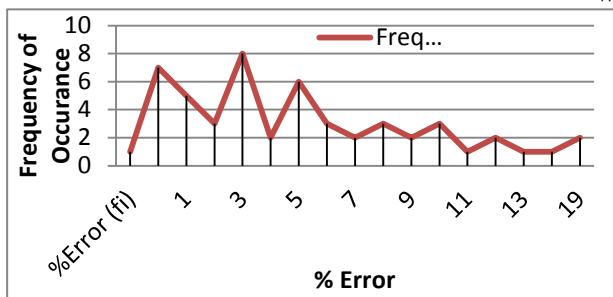

Fig. 12- % Error Frequency graph for Waste In front of Cupola : II09

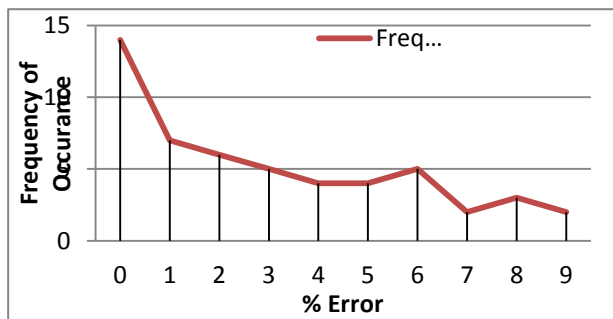

Fig. 13- % Error Frequency graph for Number of Actual Charging required : II10

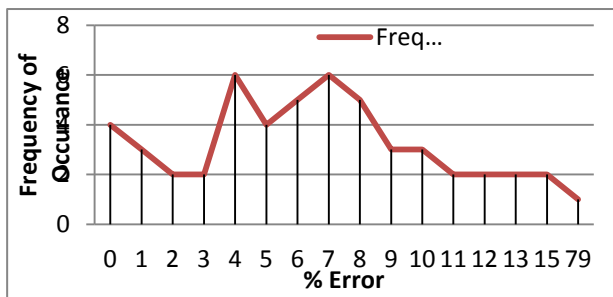

Fig. 14- % Error Frequency graph for Strength of Material : II11

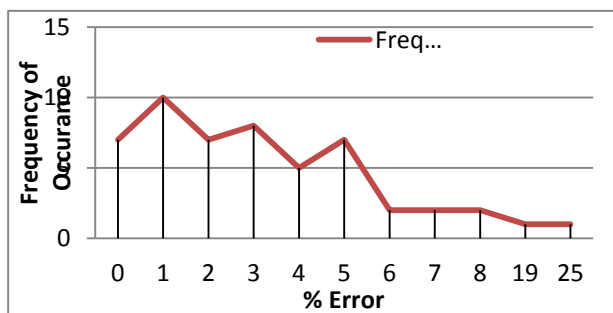

Fig. 15- %Error Frequency graph for Hardness of Material: II012

R2-CO-EFFICIENT OF DETERMINATION

A statistical method that explains how much of the variability of a factor can be caused or explained by its relationship to another factor. Coefficient of determination is used in trend analysis. It is computed as a value between 0 (0 percent) and 1 (100 percent). Higher the value the better the fit. Coefficient of determination is symbolized by r² because it is square of the coefficient of correlation symbolized by r. The coefficient of determination is an important tool in determining the degree of linear-correlation of variables ('goodness of fit') in regression analysis and also called r-square. It is calculated using relation shown below:

$$R^2 = 1 - \frac{\sum (Y_i - \hat{Y}_i)^2}{\sum (Y_i - \bar{Y})^2} \dots \dots \dots$$

Where, y_i= Observed value of dependant variable for ith Experimental sets (Experimental data), f_i=Observed value of dependant variable for ith predicted value sets (Model data), \bar{Y} = Mean of Y_i and R² = Co-efficient of Determinant

From calculation the value of R² for general Models are nearer to 1 and combined models are nearer to zero shown in Table. A value of General Model indicates a nearly perfect fit, and therefore, a reliable model for future forecasts. A value of combined model, on the other hand, would indicate that the model fails to accurately model the dataset. This shows that General Model gives better accuracy results as compared to combined model.

Co-efficient of Determinant - (R²) for mathematical model of all response variables

Calculation of the value of Co-efficient of Determinant (R²) for mathematical model of II01 to II012 calculated as below shown in tables.

Co-efficient of Determinant (R²) for % of Carbon Equivalent: II01

Here, Y_i= Observed value of dependant variable for ith Experimental sets (Experimental data)

National Conference on Current Trends in Engineering, Science and Technology (NACCTEST- 2018)
Organized by GF's Godavari College of Engineering, Jalgaon
International Journal of Innovations in Engineering and Science, Special Conference Issue, 2018
www.ijies.net

f_i = Observed value of dependant variable for i th predicted value sets (Model data)

mathematical models for reliability approach as well as R2 value approach are found better.

Y = Mean of Y_i

R2 = Co-efficient of Determination

CONCLUSION

The details have presented the approach to reliability of mathematical models. Standard life distribution and their probability density functions base for reliability approximation. Comparison of error frequency graphs with probability density function graph reveals that reliability of models is equal to reliability of these standard distributions.

Approach to the R2 values of mathematical models and clubbed models is also presented .The comparison of percentage reliability of mathematical models is made and also the R2 values of mathematical model's models are compared .From the comparison, it is noted that the

REFERENCES

- [1] *An approach for reliability prediction of instrumentation & control cables by artificial neural networks and Weibull theory for probabilistic safety assessment of NPPs Volume 170, February 2018, Pages 31, T.V.Santhosha V.Gopikaa A.K.Ghosh B.B.G.Fernandesc Reliability Engineering & System Safety*
- [2] *Reliability evaluation of time evolving Delay Volume 171, March 2018, Pages 136-151, S.K.Chaturvedia Gaurav Khannaa SietengSohb} Reliability Engineering & System Safety*
- [3] *Reliability of Cupola furnaces through field data at Jadhao steel Alloys Amravati, Research scholar & Research Guide , Hemant R. Bhagat & Dr. V. G. Arajpure*
- [4] *Impact of common cause failure on reliability performance of redundant safety related systems subject to process demand Volume 172, April 2018, Pages 129-150, Siamak Alizadeh Srinivas Srinamula*

National Conference on Current Trends in Engineering, Science and Technology (NACCTEST- 2018)
 Organized by GF's Godavari College of Engineering, Jalgaon
International Journal of Innovations in Engineering and Science, Special Conference Issue, 2018
www.ijies.net

Resolved Issues of Dew Point in Hydrogen Dryer and Improving the Performance of Generator

H. G. Patil¹ R.P. Kale² A.S.Kamadi³

¹Senior Manager, Department of Turbine and auxiliaries maintenance,
 Vidharabha Industrial Power Limited (Reliance Power), Butibori, Nagpur, India, 441122.
 E mail- Harshal.patil@relianceada.com

² AVP, Department of Mechanical maintenance, VIPL, Butibori, Nagpur 441122

³Senior Manager, Department of Turbine and auxiliaries maintenance, VIPL, Butibori, Nagpur 441122
 E mail- Harshal.Patil@relianceada.com

Abstract- A safe and reliable supply of hydrogen gas is critical to the operation of a power plant. Hydrogen gas used in the power industry should not be viewed as a commodity. Many power plants have made serious compromises to the way they utilize hydrogen to cool their generators and have negatively affected their performance. Traditional sources of hydrogen gas do not allow the plant to enhance the performance of their generators due to cost and safety concerns. The high thermal conductivity of hydrogen remains a key advantage in its use as a cooling gas in power generators. The density of hydrogen is also an advantage over that of air. Since hydrogen's density is one-fourteenth the density of air at a given temperature and pressure, the use of hydrogen reduces the windage friction losses within a generator to a small fraction of the losses encountered when the generator is cooled by air. Like any critical resource required by the plant to produce electric power, the supply and use of hydrogen gas should not be taken lightly.

Critical to the proper implementation of hydrogen cooled generator is the supply of a continuous stable flow of high purity hydrogen due to increased purity, lower dew point and stable pressure within the electric generator. Whether a plant is utilizing a large volume of gas as that are distributed throughout the plant, the goal should always be the same maintain an uninterrupted supply of pure hydrogen to meet the OEM specified requirements for generator pressure, purity, and dew point. This paper will

present the root cause analysis by Turbine maintenance engineers at VIPL power Station during a routine check to identification of problem in hydrogen gas dew point maintain in higher side and low purity.

Keywords- Dew point, moisture, Hydrogen, dryer, purity.

INTRODUCTION

Hydrogen gas is used for cooling rotor windings in power generators for several reasons. It's extremely low density offers minimal resistance to rotor rotation reducing the energy requirement for same. Furthermore, its excellent thermal conductivity makes it a very efficient carrier of heat away from the generator, where it is cooled and continuously recirculation in a closed loop. A desiccant-based dryer is usually included in the hydrogen gas circulation in closed loop. The dryer is designed for the specific purpose of removing moisture from hydrogen used in hydrogen cooling generator. Removal of the moisture is accomplished by passing the moisture laden gas through absorbent beds filled with activated alumina. The activated alumina has characteristics of large surface area and large absorptive capacity. Under normal condition after being saturated with moisture, reactivation can be accomplished by the controlled application of heat to drive off the moisture. The properties and efficiency of activated alumina are not affected by repeated reactivation. In this dehumidifier, reactivation is accomplished by heating the

National Conference on Current Trends in Engineering, Science and Technology (NACCTEST- 2018)
Organized by GF's Godavari College of Engineering, Jalgaon
International Journal of Innovations in Engineering and Science, Special Conference Issue, 2018
www.ijies.net

absorbent with embedded electrical heating elements, thus vaporizing the imprisoned moisture and at the same time passing a stream of captured hydrogen through the bed to carry off the released moisture. The stream of hydrogen is then cooled and the moisture that drops out is removed from the system through a separator and drainage system. Before the hydrogen entering the desiccant tower, the oil filter will separate the oil vapour from the hydrogen, so that the service life of absorbent materials will be extended. Having two desiccant towers, the moisture removal device is capable of continuous drying service. When one tower is removing moisture from the hydrogen in the generator, the other bed is being renewed by reactivation. The dryer operation mode consists of 8 hours absorbing and 8 hours reactivation. Reactivation consists of 4 hours heating and 4 hours cooling. It controls the flow of hydrogen diverting the flow from the tower that is saturated to the one just reactivated. This automatic shifting also places the spent bed on the reactivation cycle for renewing. Thus this dryer is completely automatic.

Pressure and purity are important factors but understanding the impact of moisture levels within the gas and accurately monitoring its dew point is critical. The presence of wet hydrogen gas is extremely detrimental to the longevity of the windings due to increased risk of corrosion and insulation failure. Therefore, it is vital that the dew point of the hydrogen gas be maintained as low as possible. The industry standard is set at -20°C dew point (or lower) for control. It is not commonly known that the quality of the hydrogen used for cooling gas in turbine generators has a significant impact on the bottom line of a power generation utility.

THE EFFECT OF HYDROGEN QUALITY ON GENERATOR OPERATION AND PERFORMANCE

The quality of hydrogen coolant gas in the electric generator station has an impact on the overall operation of an electric power generator in three principal ways:

1. Hydrogen purity directly affects the operating efficiency of the generator.
2. Hydrogen's moisture content affects the longevity of the generator's internal windings.

3. The stability of the hydrogen gas pressure within the generator affects the maximum generating capacity of the electric power generator

When the hydrogen gas coolant in the generator is high in water content, there are additional problems besides windage loss. Water vapor contamination has been shown to reduce the life of generator components, and high humidity can induce stress corrosion cracking on retaining rings and cause stator winding shorts. A common source of moisture contamination in the hydrogen coolant gas is water that becomes mixed with the hydrogen seal oil. Water content in seal oil should be maintained below 50 ppm. Plants that still operate with old braze joint materials in their stator windings, hydrogen gas coolers and other generator internal components will be affected by the production of conductive lead carbonate when high dew points are present. While there is always residual carbon dioxide present within a generator, the reaction between lead from the braze material and CO_2 that forms lead carbonate is enhanced by the presence of water. In a high moisture environment, lead carbonate is transported throughout the internal environment of the generator and will eventually find its way into exposed and less protected areas of the generator. Conductive lead carbonate will affect the longevity of internal components of a generator through induced shorts.

Stator windings are directly affected by the combination of moisture and lead carbonate. A generator's gas cooled stator windings have high voltage copper exposed at each end of the stator bars. This design feature necessitates long electrical creep age paths to prevent high voltage phase-to-phase or phase-to-ground faults. Operators of hydrogen-cooled generators have found that moisture degrades the electrical creep age strength of a surface. When moisture migrates to the end turn area of a generator's rotor windings, it attacks the inter turn insulation and results in shorted rotor end winding turns. The costs to a power generation plant for premature or unplanned shutdowns and repairs due to moisture-induced failures are significant. In addition to hard costs of parts and labor, a generator repair of this type usually means an extended unplanned plant outage and significant lost revenues.

ROOT CAUSE ANALYSIS OF HIGH HYDROGEN GAS DEW POINT

National Conference on Current Trends in Engineering, Science and Technology (NACCTEST- 2018)
Organized by GF's Godavari College of Engineering, Jalgaon
International Journal of Innovations in Engineering and Science, Special Conference Issue, 2018
www.ijies.net

In July of 2016, the dew point in VIPL power Station unit 1 generator hydrogen cooling system was measured at greater than +7.8°C. Even though the hydrogen system on unit 1 was utilizing a hydrogen dryer to remove moisture, the dew point remained at extremely high levels with no signs of improvement. VIPL Hydrogen dryer root cause Analysis based on feedback data in CCR Unit#1 H2 Dryer performance:

1. Tower regeneration temperature requirement is between 120 to 180 degree.

2. Equipment adsorption effect is poor and equipment inlet/outlet dew point temperature is close and equipment water discharge volume during regeneration process is very less (20ML/8h) given below details analysis report in table.

Table 1 Hydrogen dryer performance before changing absorbent material.

Unit-1 Hydrogen dryer performance									
Time	Tower temp °C		Tower in service	Recirculation line temp °C	Dew point °C		Hydrogen pressure in bar	Hydrogen pressure in purity	Moisture collection in ML
	A	B			Inlet	outlet			
4 AM	42	62	A	40	1.3	-6.9	2.9442	98.5 %	20 ML
5 AM	39	103	A	50	0.5	-5	2.9301	98.4 %	
6 AM	39	116	A	60	0.3	-3.4	3.002	98.53 %	
7 AM	39	125	A	64	0.2	-2.9	2.987	98.52 %	
8 AM	39	95	A	66	0	-2	2.9897	98.51 %	20 ML
9 AM	40	71	A	66	0.6	-1.6	2.9905	98.51 %	
10 AM	41	55	A	57	1.4	-0.8	2.9868	98.49 %	
11 AM	42	50	A	52	1.7	-0.3	2.9756	98.48 %	
12 AM	54	42	B	42	1.9	-1.5	2.9682	98.49 %	
1 PM	121	42	B	54	2	-0.2	3.0055	98.48 %	
2 PM	139	42	B	60	2.1	2	2.993	98.45 %	
3 PM	146	42	B	64	4	5	2.9886	98.41 %	
4 PM	111	43	B	68	5	6	2.9663	98.4 %	
5 PM	82	43	B	66	6	7.8	2.9632	98.4 %	

VIPL power station determined that the gas dryer in the hydrogen system was continuous operational and needed to be replaced of absorbent material fail or polluted by oil and equipment regeneration function effect fail. The implications of operating an electric generator with high gas

dew point can affect the overall reliability of the generator and should not be ignored. Water vapor contamination inside a generator has been shown to reduce the life of its components, and high humidity can induce stress corrosion cracking on its retaining rings and cause stator winding

National Conference on Current Trends in Engineering, Science and Technology (NACCTEST- 2018)
Organized by GF's Godavari College of Engineering, Jalgaon
International Journal of Innovations in Engineering and Science, Special Conference Issue, 2018
www.ijies.net

shorts. It is recommended that the hydrogen dew point be maintained below -20°C in most generators, but will vary depending on the generator's original equipment manufacturer (OEM), the size of the generator, and the hydrogen gas pressure. Root cause analysis have carried out that generators that operate with high hydrogen gas dew point are much more susceptible to insulation degradation in windings that inevitably lead to disastrous shorts and major unplanned repair actions. It is well understood by power plant operators and recommended by generator OEMs that hydrogen gas dew point should be kept as low as possible to insure reliable operation of the generator. SEC manufacture and Chinese engineer advised VIPL that all efforts should be made to keep the hydrogen dew point in the plant's generators below -20°C . The costs to a power generation plant for premature or unplanned shutdowns and repairs due to moisture induced failures can be significant. In addition to hard costs of parts and labor, a generator repair of this type usually means an extended plant outage and significant lost revenue.

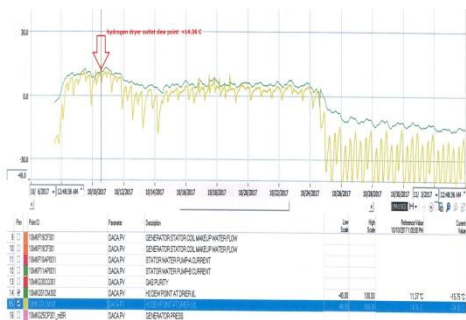

Fig.1 Hydrogen dryer dew point maintains higher side.

A dew point sensor should be considered for continuous gas monitoring to improve the efficiency and longevity of the generator. A dew point sensor that is placed in the hydrogen dryer stream of a continuously flow to generator will provide valuable feedback to CCR. The dew point data can be used to trend moisture over time to help identify the sources of moisture ingress. The analyzer that is used to determine the purity level of hydrogen as well as the dew point of the hydrogen gas.

RESOLUTION OF HYDROGEN DEW POINT AND PURITY IMPROVEMENTS

Hydrogen Dryer analysis was conducted by TGM engineer to find a suitable supplier for replacement absorbent material which yielded several reputable manufacturers that proposed the replacement of all hydrogen absorbent material drying systems at the plant. It was understood that to purchase new absorbent material in dryers. Also improve the quality of the coolant gas to meet OEM specifications without installing new dryers.

For root causes point 1:

1. Check the adsorbent brand and property. OEM's supply is UOP brand absorbent.
2. Check the reason for replacement of adsorbent, any abnormal observed for initial replacement.
3. Check whether dryer is polluted by oil, checking the water discharge oil percentage.



Figure 2 absorbent material size more than 5 mm

For root causes point 2:

1. Observe equipment local cooler outlet temperature.
2. Fully close regeneration flow regulation valve AA001 and then open for 1 circle.
3. During tower regeneration observe inner temperature. The heating period for tower regeneration is 4 hours. Adjust the regulation valve AA001 during this period, to ensure after heating finished, the tower inner temperature is between $120\sim 180$ degree, cooler inlet temperature is between $50\sim 80$ degree (30 degree difference to outlet temperature, depend on site cooling water temperature condition).

National Conference on Current Trends in Engineering, Science and Technology (NACCTEST- 2018)
Organized by GF's Godavari College of Engineering, Jalgaon
International Journal of Innovations in Engineering and Science, Special Conference Issue, 2018
www.ijies.net

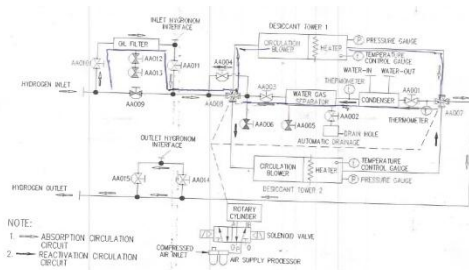

Figure 3 Hydrogen dryer working flow circuit diagram

4. Open valve AA001, will increase cooler inlet temperature, decrease tower inner heating efficiency.
5. Close valve AA001, will decrease cooler inlet temperature, increase tower inner heating efficiency.
6. Open or close valve AA001 shall be step by step, each step is around 1/8 circle, after each adjustment, it will take 15~20 minutes for temperature to reach stable condition.
7. After 4 hours heating, if not solve the problem, press 'MENU' button screen.
8. Press 'STOP', and then select 'TOWER 1 ABSORPTION FIRST', and then press 'START', restart the equipment.
9. Record when #2 tower regeneration heating finished, #2 tower inner temperature, cooler inlet and outlet temperature, water discharge volume.
10. Repeat above adjustment on #1 tower regeneration.

11. Based on site hydrogen dew point situation, dryer water discharge volume shall be hundreds liters.

RESULTS OF HYDROGEN DRYER DEW POINT AND PURITY IMPROVEMENTS

Although plant On July 15, 2016 a hydrogen generator was to supply high purity hydrogen to unit 1 at VIPL power station and the Stable Flow continuous hydrogen filling in generator required for maintaining hydrogen purity. Illustrated below (Figure 4) is a summary of the dew point improvement results during the 545 days of operation. Keep in mind that the dew point prior to installing the proposed solution was extremely high and it was determined that greater than 545 days would be required to achieve the plant's desired dew point. It was agreed that if the initial results were significant and the trend was one of improvement and continue to monitor the results.

On July 15, 2016 the dew point measured on unit 1 was +7.8°C

By October 10, 2017 the dew point was down to about +14.36°C, after replacing absorbent material activated aluminum oxide as per UOP brand with change sphere size 3 mm.

By October 25, 2017, the dew point was between -38°C and -39°C.

National Conference on Current Trends in Engineering, Science and Technology (NACCTEST- 2018)
 Organized by GF's Godavari College of Engineering, Jalgaon
International Journal of Innovations in Engineering and Science, Special Conference Issue, 2018
 www.ijies.net

Table 2 Hydrogen dryer performance after changing absorbent material size

Unit-1 Hydrogen dryer performance									
Time	Tower temp °C		Tower in service	Recirculation line temp °C	Dew point °C		Hydrogen pressure in bar	Hydrogen pressure in purity	Moisture collection in ML
	A	B			Inlet	outlet			
8 AM	35	108	A	50	-13.2	-39.9	3.0555	99.34 %	100 ML
9 AM	35	138	A	60	-13.3	-39.9	3.0555	99.34 %	
10 AM	36	142	A	66	-13.2	-39.9	3.0657	99.33 %	
11 AM	36	119	A	70	-13.0	-39.3	3.0704	99.31 %	
12 AM	37	75	A	70	-12.9	-32.4	3.0704	99.30 %	40 ML
1 AM	38	64	A	62	-12.5	-26.8	3.0704	99.28 %	
2 AM	38	57	B	52	-12.0	-21.4	3.0611	99.28 %	
3 AM	100	38	B	58	-11.8	-33.4	3.0611	99.29 %	
4 AM	133	37	B	60	-12.1	-35.8	3.0536	99.29 %	
5 PM	162	37	B	67	-12.3	-31.8	3.0472	99.34 %	
6 PM	168	37	B	74	-12.5	-25.0	3.0425	99.34 %	
7 PM	142	37	B	75	-12.5	-21.3	3.0388	99.28 %	
8 PM	78	37	B	66	-12.3	-17.6	3.0340	99.28 %	
9 PM	64	37	B	53	-12.2	-15.8	3.0072	99.27 %	

National Conference on Current Trends in Engineering, Science and Technology (NACCTEST- 2018)
 Organized by GF's Godavari College of Engineering, Jalgaon
International Journal of Innovations in Engineering and Science, Special Conference Issue, 2018
 www.ijies.net

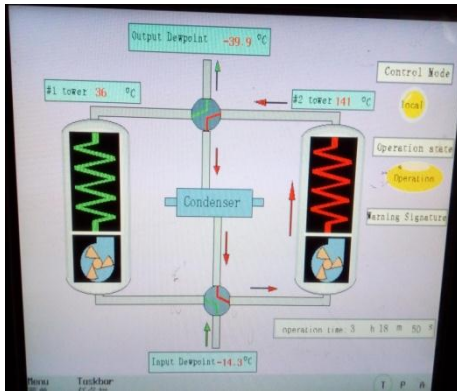

Figure 4 below Hydrogen gas outlet dew point maintaining -39.9 to -40.2 C

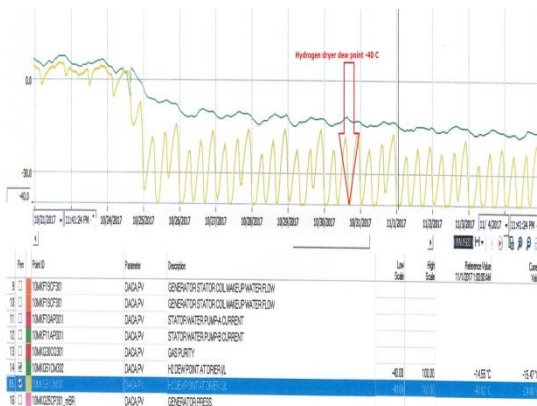

Figure 5 above illustrates the steady decline in hydrogen gas dew point over a two week period during the evaluation period.

Hydrogen gas purity was measured above 99.25% following the first full week of operation. VIPL TG maintenance decided to purchase the hydrogen dryer absorbent material after the evaluation period. The proposed solution of hydrogen dryer and the implementation of the Stable dew point reduce the hydrogen consumption. In addition to operating the generators with a higher level of purity and lower dew point.

CONCLUSION

A safe and reliable supply of hydrogen gas is critical to the operation of a power plant. Hydrogen gas used in the power industry should not be viewed as a commodity. Many power plants have made serious compromises to the way they utilize hydrogen to cool their generators and have negatively affected their performance. Traditional sources of hydrogen gas do not allow the plant to enhance the performance of their generators due to cost and safety concerns. Conclusion of root causes analysis of hydrogen dryer

1. Absorbent material fail or polluted by oil
2. Equipment regeneration function effect fail

VIPL also implemented above issues resolve an innovative technique to continuously improve dew point in generator, which dramatically improved the gas quality in the generator casing. The improved gas quality has resulted in very low dew point in the casing as well as increased generator efficiency and capacity. These improvements have all impacted the performance of the electric generator and will ultimately impact the plant's bottom line.

REFERENCE

[1] Albright, J.D. and Albright D.R., *Generatortech, Inc.* "Generator Field Wind-ing Shorted Turns: Moisture Effects". Presented at EPRI — Steam Turbine Gen-erator tech Workshop and Vendor Exposition, Nashville, Tenn., August 25-27, 2003.

[2] Borkey, Ed (general manager, Fluid Energy); Reynolds, Tom (electrical engineer, Progress Energy). "Water Contamination in Hydrogen-Cooled Genera-tors Lurks as Serious Operational Threat". *Power Engineering*, August 2003.

[3] Vandervort, Christian L. and Kudlacik, Edward L. *GE Power Systems, Schenectady NY: GE Generator Technology Update*, April 2003

[4] Bothwell, Jim, *Jim Bothwell Consulting, Stuart, FL* "Monitoring Moisture in Hydrogen Cooled Generators". Presented at EPRI Conference – Oct 1983

[5] *GE Power Systems' Generator Products Overview*, October 2003.

National Conference on Current Trends in Engineering, Science and Technology (NACCTEST- 2018)
 Organized by GF's Godavari College of Engineering, Jalgaon
International Journal of Innovations in Engineering and Science, Special Conference Issue, 2018
www.ijies.net

Improving the efficiency of Boiler Feed Pump by modification of Recirculation Valve Plug and Seat Ring

H. G. Patil¹ R.P. Kale² K.R.Jadhao³

¹ Senior Manager, Department of Turbine and auxiliaries maintenance
 Vidharabha Industrial Power Limited (Reliance Power), Butibori, Nagpur, India, 441122.

² AVP, Department of Mechanical maintenance, VIPL, Butibori, Nagpur 441122

³ GM, Department of Turbine and auxiliaries maintenance, VIPL, Butibori, Nagpur 441122
 E mail- Harshal.Patil@relianceada.com

Abstract – Control valves for severe service application operating under high differential pressure and cavitation flow are always at risk for damages. In thermal Power Plant all six control valves on Boiler Feed Pump Minimum of recirculation line developed excessive seat leakage within short span of a year of operation. The BFP recirculation valve of operation is used because it is believed it provides more robust control of the minimum flow; however flow losses do occur. The linear system of control causes more losses and hence greater power consumption. Cavitation can occur in control valves handling feed water, causing loud noise as well as damaging valve components and ultimately leading to additional costs. When actions for preventing cavitation are considered, it is essential to recognize the existence of cavitation and location of cavitation inception point. In control valve components and systems cavitation can occur in various locations where the access for measuring instruments is limited. Therefore, the existence of cavitation is often very difficult to detect. Excessive leakage from this control valve impacted non-availability of Boiler Feed Pump for operations and affected reliability of power generation units. Modification of plug and seat reduces these leakages losses by measuring the feed water level, thereby resulting in a lesser loss of pressure and hence lesser demand. In this review paper, cavitation phenomenon is explained and effects of cavitation in the control valves are dealt. This paper presents details account of the

failure of valve components causes of cavitation, its analysis and countermeasure of replacing the internal

plug and seat with modification used to control or eliminate it and its success story.

Keywords- Cavitation, Control valve, material, erosion, corrosion, Boiler feed pump

INTRODUCTION

When a motor driven boiler feed pump discharge flow, some of the energy generated from the pumping action is converted to heat. If the pump discharge flow falls below a set minimum level there is a rapid increase in both temperature and Pressure within the pump. This increase can cause mechanical pump damage due to cavitations or excessive pressures. To guard against this, a minimum flow line is used downstream of the pump discharge. This minimum flow line takes the full discharge pressure from the pump and passes a set minimum flow to the deaerator, feed storage tank. The feed water valve cannot serve this purpose as the full head of the boiler is on the feed water valve outlet at start-up on some older, small units there is merely an orifice in the minimum flow line and the line is left open at all times. Substantial loss of energy will be noticed in this arrangement as this minimum flow line is leaking off flow that should be going to the feed storage tank for minimum level of pump suction required. Therefore, it is much more cost effective to install a boiler feed pump recirculation valve

National Conference on Current Trends in Engineering, Science and Technology (NACCTEST- 2018)
 Organized by GF's Godavari College of Engineering, Jalgaon
International Journal of Innovations in Engineering and Science, Special Conference Issue, 2018
 www.ijies.net

in this minimum flow line. Once the pump flow is above a set minimum level the recirculation valve is closed and full pump flow is supplied to the boiler drum. The typical operating sequence for this valve is as operated when the boiler feed pump is first started, the recirculation valve will be opened and the feed water valve will be slowly opened as the planned comes on line. Once the feed water valve reaches 10% to 25% of pump capacity, the recirculation valve will go closed. This recirculation valve will remain closed until the pump flow falls below the 10% to 25% level, at which time the recirculation valve will automatically open to guard against the rapid heat and pressure rises. Therefore, the boiler feed pump recirculation valve will be in the closed position for 90% to 95% of the time in most power plants. This valve will also have the highest differential pressure across the seat of any other valve in the plant. This makes the recirculation valve one of the most severe duty valves in a generating plant.

Control valves play a crucial role in safely controlling high process feed water energy levels to avoid valve and piping damage. Control valves consist of two main parts: the valve body, which conveys and directs the flow; and the actuator, which provides the necessary force for the movement of valve components. The rate of flow passing through the globe valve is changed by adjusting the distance between a stationary seat and a movable plug. Cavitations are one of the limiting parameters in the design and fabrication of globe control valves. Due to small opening in the initial stage of the valve, there is sudden flow occurs and this causes high velocity of flow, hence this turbulent flow erodes the plug element and loses all characteristics of valve. Therefore a control valve designed with hardened plug and seat material could last almost indefinitely on low pressure drop service conditions. In order to eliminate the cavitations phenomenon or to reduce its intensity, a series of perforated cylindrical plates called trim. These trim cause a multi-stage pressure drop in the flow and prevent the sudden drop of the feed water pressure to a lower point than its saturation vapor pressure. Therefore, the onset of cavitations is delayed, and at high flow rates, at which the occurrence of cavitations is unavoidable, the intensity and the extent of the cavitations are reduced.

1. FAILURES IN CONTROL VALVE

In typical power plants there are hundreds of control loops. Most of these loops include a control valve as the

final control element. Therefore, reliable system performance is directly associated with the control valve reliability. It takes a large number of control valves to run a power plant, and while some valves are more critical to plant operations than others, it always follows that when a severe service valve fails, the plant goes short shutdown or long shutdown depends upon defect. Feed-water level control valves fall within this severe service category. These valves are of particular importance since they often fall victim to cavitations, with resulting damage to the valve plug and seat. When this occurs it causes leakage at shutoff, lack of control during startup, and high and/or low drum level alarms. The operating sequence of a feed-water level system during startup requires that the control valve immediately downstream of the feed-pump have a high inlet pressure and a low downstream pressure.

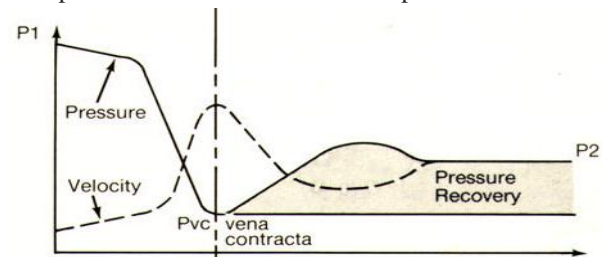

Figure 1 Comparison of Pressure and velocity profile of Control valve

At this point it is necessary to discuss the effects of reducing the pressure of feed water. In the case of the BFP recirculation valve, inlet pressures between 220 bars must be reduced to outlet pressures between a vacuum and 7.8 bars. As feed water travels through a restriction it can be observed that as the pressure drop increases so does velocity until it reaches a maximum level in the vena contracta area immediately downstream of the restriction. Beyond the vena contracta the pressure recovers and the velocity decreases. Figure 1 shows the relationship between pressure and velocity in a single point-throttling valve. From this figure you will note that there is an overshoot of the pressure before it recovers to the exit pressure. The amount of overshoot is a function of the required pressure drop. It is during this overshoot period that the temperature of the feed water comes into effect. If the temperature of the feed water is such that at no time during pressure reduction is the vapour pressure of the feed water approached, then no adverse effects will be noted. When the final pressure is close to the saturated vapour pressure, problems can arise. Referring to Figure 1, the following three aspects of feed water

National Conference on Current Trends in Engineering, Science and Technology (NACCTEST- 2018)
Organized by GF's Godavari College of Engineering, Jalgaon
International Journal of Innovations in Engineering and Science, Special Conference Issue, 2018
www.ijies.net

pressure reduction indicate the significance of feed water temperature:

A) NORMAL PRESSURE REDUCTION

Curve 1 of Figure 2 illustrates the pressure drop through a valve where the vapour pressure is not approached during the pressure reduction. No change in state occurs and the feed water remains

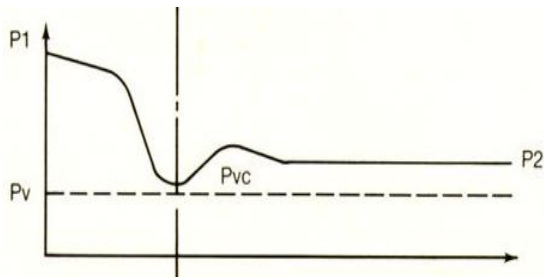

Figure 2 Normal Pressure Reduction curve

B) Flashing In

Curve 2 of figure 3, it can be noted that during the throttling the pressure profile falls below the vapour pressure line. Immediately, a portion of the feed water will vaporize and vapour bubbles will be formed in the feed water flow, giving rise to two-phase flow. When this occurs a mixture of feed water and vapour exists, and the vapour portion results in an increased volume, which, in a confined space, will result in an increase in velocity.

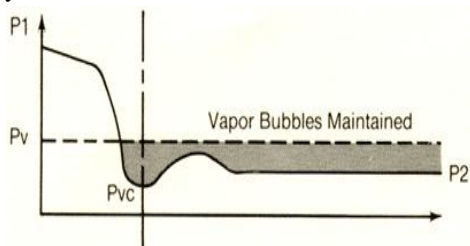

Figure 3 Flashing in Control valve

C) CAVITATION

From Curve 3 of figure 4 it will be seen that during the pressure recovery the pressure profile rises through the vapour pressure line. At this point, vapour bubbles that were formed in the feed water stream in the low-pressure vena contracta area cannot exist at a higher pressure and will collapse and implode back into a feed water state. When the vapour bubbles collapse the cavitation process is complete. As the vapour turns back into feed water, voids will occur in the flow stream and feed water rushing into these voids will set up high-pressure shock

waves. Some investigations into this phenomenon have recorded pressures as high as 220 bar. One or more of the following will generally accompany the occurrence of cavitation within a valve: noise, vibration, and material damage. Incipient cavitation is usually detectable as a hissing noise emanating from the downstream of the valve. As the intensity of the cavitation increases, the noise will increase until in the fully developed stage of cavitation the noise can best be described as a crackling, rattling sound giving the impression that gravel is passing through the valve. Vibration due to cavitation will depend on several factors, including the mass of the system and how well it is anchored. In addition, actuator stiffness can go quite a ways to control the vibration. With severely cavitation conditions, vibration can reach dangerous proportions. Both cavitation and flashing can result in plug and seat oscillation, particularly on pressure-balanced, flow-over-the-seat plug designs.

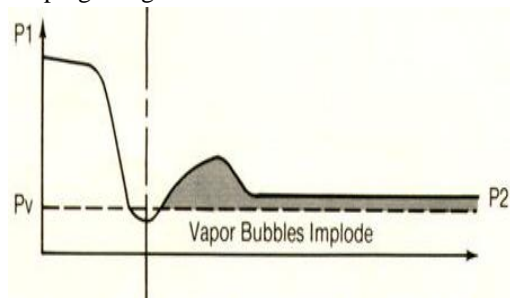

Figure 4 Cavitation in Control valve

The effect of the vapour bubbles forming and collapsing, specifically beneath the plug, can result in pressure fluctuations beneath the plug, which are not matched by static pressure above the plug. The most serious effect of cavitation is the material damage, which can occur. Under severely cavitation conditions, implosions occur as the vapour bubbles collapse. If these implosions occur near a solid boundary, such as the valve plug and seat or valve body, the shock waves that occur result in material damage. Under severely cavitation conditions even extremely hard components will fail in a short period of time. The sort of damage that cavitation is capable of. This shows a Plug and Cage that has been in cavitation service for only a few Months. As is obvious the plug, cage and seating material have been completely destroyed and a replacement or rebuild plug and seat set would be needed every or two years to keep this valve in service. Plug and seat will extend the life of the valve and reduce the cost of maintenance. A material's resistance to cavitation increases with its hardness, but at

National Conference on Current Trends in Engineering, Science and Technology (NACCTEST- 2018)
 Organized by GF's Godavari College of Engineering, Jalgaon
International Journal of Innovations in Engineering and Science, Special Conference Issue, 2018
 www.ijies.net

present no material exists that will give reasonable life under severely cavitation conditions.

2. ANALYSIS OF BFP RECIRCULATION VALVE

In most of units having MD BFP only, drum level control is accomplished through DP mode because it is believed that has robust control. But it results in appreciable energy loss due to throttling of FRS valve. As evident from the observations above made, there is a considerable increase in pressure drop which was measured in full valve open condition. This higher pressure drop results in high demand for the BFP to work continuously at full load. Thereby generating an enormous potential for wastage energy and decreasing efficiency of the whole boiler operation system. Thus, it was seen that a slight loss in control can correspond too much greater efficiency and overall a better system of operation. Status before disassembly for BFP recirculation valve approximately over 43t/h leakage was observed during running condition. Internal Parts Inspection during Unit short shutdown in December 2015.

1. The valve body was severely eroded corresponding to the metallic gasket and thread. See below.



2. The seat of the seat ring was eroded in the location shown below.



3. The seat of the plug was eroded in the location shown below.



4. The cage was damaged corresponding to the metallic gasket and some holes were deformed and choked due to metal and welding particles.

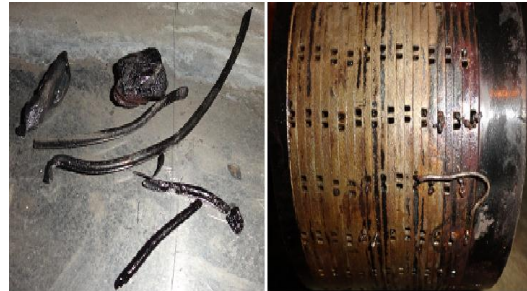

5. Upper and lower Metallic gasket and seal ring were never remained in the valve body.



3. MODIFICATION OF BFP RECIRCULATION VALVE PARTS

The modification consists of moving the plug seating area to the inside of the plug from seat ring, see Figure 5. The inside seat construction utilizes a metallic ring around the lower portion of the plug to prevent damage due clearance flow. As a result of this change, the seat surface would be apart from the straight clearance flow. Also the position of the metallic ring was changed under the cage to control the attack of the flow during the seat

National Conference on Current Trends in Engineering, Science and Technology (NACCTEST- 2018)
Organized by GF's Godavari College of Engineering, Jalgaon
International Journal of Innovations in Engineering and Science, Special Conference Issue, 2018
www.ijies.net

leakage. And using modification for plug and seat also the travel low-cut off was settled as 18% of the full stroke to make sure the use at the minimum throttling Cv. The change was done by the adjustment of the value in DVC (Digital Valve Controller). Further, the compression of the metallic gasket was changed to 20% by reducing the height of the metallic gasket and seal ring groove due to secure the gasket. The supply air pressure was changed 3.8 Bar to 5 Bar to get more seating load by the actuator with steam plug on seat.



SUMMARY OF MODIFICATION:

The eroded plug, seat were visually inspected in the workshop. Noticeable damage of main plug and seat were seen (at two close locations assumed to be facing the valve inlet side) along with wear across the pilot plug and seat. Similar erosion is seen in BFP recirculation valves designed with PTFE balance seals in many other plants which are caused by slight deflection of plug by the fluid pressure at the valve inlet side which happens due to soft balance seals and improper plug seat contact. The problem aggravates with increase in erosion across pilot plug/seat, which lowers the seat load on the Main plug.



SOLUTION: Below are the design modifications foreseen to avoid such failure

1 The existing pilot plug is held onto the Main plug with a Circlip design which is NOT a robust construction and prone to deflection. Upgrading this design to retainer ring with hexagonal bolts will avoid plug deflection and reduce wear of pilot plug and seat.

2 When the valve is opened and throttling, the present design construction of bonnet allows fluid to flow to the top of the bonnet cavity at P1 pressure and the Pilot plug when opened sees P1-P2 pressure across it, thus resulting in wear due to high pressure drop. This can be avoided by introducing two piston rings (Inconel) with close fit tolerance which guides the plug inside the bonnet cavity.

3 The plug / seat angle to be modified to ensure line contact.



Figure 5 Modification of seat ring and plug in control valve

BFP recirculation valve operation was successfully tested in each BFP. Pressure drop across FRS valve is observed to be **10 kg/cm²** in valve full open condition and there by generating an enormous potential for energy saving and increase of each BFP efficiency and

National Conference on Current Trends in Engineering, Science and Technology (NACCTEST- 2018)
Organized by GF's Godavari College of Engineering, Jalgaon
International Journal of Innovations in Engineering and Science, Special Conference Issue, 2018
www.ijies.net

Ampere saving achievement is given below:

Table 1 Observations and savings per BFP unit

UNIT - 2	AMP. Gain/Hr	KW saving/Hr
BFP - 2A	1.3	14
BFP - 2B	2.6	26
BFP - 2C	4.5	39

BFP hydraulic coupling's response time and subsequent change in drum level shows that drum level control directly through BFP scoop operation in three element mode variation is quite feasible especially under steady operating condition. Sustainable loss of energy will be noticed in this arrangement as this minimum flow line is leakages off flow that should be going to feed water tank.

Estimated energy saving, assuming a 95 % motor efficiency are as follows

Total saving in KW = Before old plug and seat valve power consumption – After modification of plug and seat valve power consumption
= 4200 – 3980

Total saving in KW = 220 KW

Total cost saving in Rs = Total saving in KW x working hour x days x Availability of pump x variable cost
= 220 x 24 x 365 x 0.95 x 2.7

Total cost saving in Rs = 49,43,268.

CONCLUSION

Cavitation is a harmful phenomenon in a control valve components and systems. It not only disturbs the flow continuity and changes the physical performance, but also, in many cases, it results in undesirable effects such as intensive noise, vibration and erosion of the solid surfaces subjected to it. Therefore, the investigation about cavitation is of practical significance and more research about the cavitation phenomenon is to be carried out. According to literature, there are several types of devices and techniques that have been used for collecting data about cavitation erosion in laboratory tests. It was concluded that the Modification of plug and seat parts is to be a permanent solution of the problem. It was observed for six valves had trace of erosion on seat surface by foreign particles but this erosion could be repaired by re-machining. Even the eroded seat on

valves, the seat contact line on all valves was remained tightly in all surroundings of the seat and it means that the seating condition was secured until a foreign particle in the water scratches the seat. And then, the feed water passed through in the seat and erosion has expanded. Be to say from extensive field experience, such erosion is to be often occurred under the normal unit operation. And if the erosion is left, damage must be much more severe conditions. Especially in the high pressure services, the tendency of this phenomenon is remarkable. Therefore, it is recommended to have a proper periodical overhauling, like every year(s), and if some trace of erosion are found, it is better to repair the seat damage before it grows to major erosion. By modification of plug and seat will help to reduce the cavitation related problems and provide reliable, cost effective control valve solutions. Also it strongly recommended the following maintenance plan referring to the inspection result:

1. Checking if any air leakage from instrumentation and their fitting/tubing.
2. Checking if pressure of both top/bottom sides in the actuator is properly charged to assure the valve would be fully closed.
3. Checking if any leakage at inside of body, confirming the temperature increase and/or indication of the flow in downstream when the valve is fully closed.
4. It is recommended to stock spare parts at least two (3) sets of the plug and seat parts for the emergency services in the future.

REFERENCES

- [1] *Cavitation in Control valves, SAMSON Technical Information (03 /11 Part 3 –L351EN), Frankfurt.*
- [2] *Cavitation in Valves, Valmatic valve and Manufacturing Corporation.*
- [3] *James A. Stares, Chief Engineer-Masoneilan, Dresser – Masoneilan Control Valve Cavitation, Damage Control, Feb-2007.*
- [4] *H. Soyama, H. Kumano and M. Saka, A new parameter to predictcavitation erosion, CAV2001: session A3.002.*
- [5] *YLeC Consultants for EDF, A Method to evaluate Cavitation Erosion in valves, Third International symposium on Cavitation, April 1998, Grenoble, France.*
- [6] *C. Samuel Martin , H. Medlarz , D. C. Wiggert , CavitationInception in Spool Valves, 5641 Vol. 103, DECEMBER 1981 Transactions of the ASME.*
- [7] *Sandor Bernad, Romeo SUSAN-RESIGA et al, Cavitation phenomenon in hydraulic valves. Numerical modeling*

National Conference on Current Trends in Engineering, Science and Technology (NACCTEST- 2018)
 Organized by GF's Godavari College of Engineering, Jalgaon
International Journal of Innovations in Engineering and Science, Special Conference Issue, 2018
 www.ijies.net

proceedings of the Romanian academy, Series A, Volume 8, Number 2/2007.

- [8] Yongjian Li, Haosheng Chen, Jiadao Wang, Darong Chen [11], Effect of Grooves on Cavitation Around the Body of Revolution, *Journal of Feed water Engineering ASME*, JANUARY 2010, Vol. 132/ 011301-1.
- [9] Lian Zhanghua, Meng Yingfeng, Liu Gan, Yi Hao , Fluid field analysis of high pressure throttle valve and its structure improvement, *PHOENICS User 2004's International Conference, Australia, May, 2004.*
- [10] Dipl- Ing. Q. Chen and Prof.Dr.-Ing.B.Stoffel, CFD simulation of a Hydraulic conical valve with cavitation and poppet movement, *Darmstadt University Of Technology Germany.*
- [11] F. Franzoni, M. Milani, L. Montorsi, Cavitating flows in hydraulic multidimensional CFD analysis.
- [12] Ashok K. Singhal, Mahesh M. Athavale *Mathematical Basis and Validation of the Full Cavitation Model, Journal of Feed water Engineering ASME SEPTEMBER 2002, Vol. 124-617.*
- [13] Sandor BERNAD, Sebastian MUNTEAN, Vortex flow analysis in poppet valve chamber, *The 6th International Conference on Hydraulic Machinery and Hydrodynamics Timisoara, Romania, October 21 - 22, 2004.*
- [14] GAO Hang, FU Xin, HANG Hua-yong, Numerical Investigations of cavitating flow behind the cone of a poppet valve in water hydraulic system, *Journal of Zhejiang University Science V.3.No.4, P.395-400, Sep-Oct 2002.*
- [15] Young Joon An, Byeong Jin Kim and Byeong Rog Shin, Numerical analysis of 3-D flow through LNG marine control valves for their advanced design, *Journal of Feed water Engineering ASME DECEMBER 2002, Vol. 124/ 1011.*
- [16] N. Berchiche , J. P. Franc , J. M. Michel , A Cavitation Erosion Model for Ductile Materials , *Journal of Feed water Engineering , SEPT 2002, Vol. 124 / 601*
- [17] Singleton E W. - "Control Valves – Notes on the effects of high pressure reduction, Cavitation – Erosion – Vibration." Published by Koso Kent Introl – May 2005.
- [18] ANSI/FCI Standard 70/2-2006 "Classification of seat leakages"
- [19] ISA Recommended Practice RP.75.23 – 1995 "Evaluation of control valve cavitation."
- [20] IEC Standard – 60534-2-1 "Control valve sizing equations"
- [21] IEC Standard - 60534-2-3 "Control valve flow capacity test Procedures."
- [22] IEC Standard - 60534-2-4 "Control valve inherent flow characteristics and rangeability."
- [23] ANSI/FCI Standard 70-2 "Control valve seat leakage.

National Conference on Current Trends in Engineering, Science and Technology (NACCTEST- 2018)
 Organized by GF's Godavari College of Engineering, Jalgaon
International Journal of Innovations in Engineering and Science, Special Conference Issue, 2018
 www.ijies.net

Throwing Profile and Tools on the Potter's Wheel for The Production in the Pottery: A Critical Review

Nandkishor M. Sawai¹, Dr. V. G. Arajpure², and Dr. C. C. Handa³

¹Ph. D. Scholar,
 Mechanical Engineering,
 nandkishor_sawai@rediffmail.com

²Principal,
 Godavari College of Engineering, Jalgaon, India

³Professor and Head of Department
 Mechanical Engineering, K.D.K.C.E, Nagpur, India

¹Email:- nandkishor_sawai@rediffmail.com

Abstract - Pottery is our earliest handicraft in prehistoric times; most of the clay was shaped on the wheel. In this paper, review existing throwing profile on the potter's wheel which is technological innovation. In this technological innovation, by the new idea, modification for throwing profile process gauges or tools used on the potter's wheel for the shaping of clay or earthen ware. Push clay down, with the left hand also push the left side of clay and with right hand press down on the top of it. Pull fingers of right hand outward, for cylinder; keep floor flat, for bowl; let fingers curve up wall to establish curve. During throwing profile, the surface of the clay body becomes smeared so that agate patterning is obscured. The prepared clay ball is then centred on the wheel. Once centred, the clay ball is opened and pulled quickly into a cylinder. During throwing, the surface of the clay body becomes smeared so that agate patterning is obscured. This throwing process used hands, left and right. The study specifies factors influencing the throwing process and recommends of tool replaced by hands. These are based on a systematic analysis of the throwing process and testing of a prototype throwing process consisting of standard tools. For which we consider literatures reviews & some of them are explained.

Keywords: Throwing process, throwing profile equipments or tools, earthen ware, potter's wheel.

INTRODUCTION

Many countries are involved in production of earthen pot/ clay pot. Different types of clay pot included earthen pot, ceramics, crockery, pottery or earthenware. Earthen pots are extensively used in countries like India, Nigeria, Nepal, Pakistan etc... in the rural area. Earthen pot is made either manually by using layer of clays or throwing on the potter's wheel.

The throwing on the potter's wheel technique is important in making of an earthen pot. Throwing profile and tools is the best of all the clay shaping processes on the potter's wheel. The goal is to provide technological solution to shaping to clay on the potter's wheel. The potter imparts his creativeness on a lump of clay spinning on a potter's wheel, using his thumbs, fingers and palms. Pottery making is done by fine finger movements with a focus on both finger movements common among potters and on unique pot-forming procedures developed by each potters.

National Conference on Current Trends in Engineering, Science and Technology (NACCTEST- 2018)
 Organized by GF's Godavari College of Engineering, Jalgaon
International Journal of Innovations in Engineering and Science, Special Conference Issue, 2018
 www.ijies.net



Fig. 1- Throwing on potter's wheel [2]

Potters have been throwing on the potter's wheel since many decades, which makes it one of the longest held traditions still kept by modern potter. Despite its ancient origin, and use by what we can assume to be billions of potter's over the millennia, every potter's technique at the potter's wheel is personal, if not unique. To build your technique, the basic steps of wheel throwing. To make any clay pot on the wheel you need to follow three things:

1. Centering the clay: Throw the clay onto center of a bat on the wheel. The clay on the wheel, trying to center the clay, Tap/slap clay to be sure it is stuck to the potter's wheel, wet hands and ball of clay with water. Starting with a high speed of the potter's wheel and cup the clay. Anchor arms on knees or wheel tray, hold hands steady and try to form clay into a cone shape, flatten cone shape by steadying clay with one hand and flattening with the other hand. If the clay is centered, hands do not move when clay forms into a cup shape.



Fig. 2- Centering process in throwing [3]

2. Drawing up: Slow speed of potter's wheel and squeeze some water from your sponge all over your cylinder. Place your left hand inside of your opened cylinder with your fingers pointing down. Your hands should be directly aligned, one on the inside, one on the outside. Gently use pressure on both knuckles to guide clay in an upwards position. Position your right hand the same way on the outside and cross your thumbs.



Fig. 3- Drawing up process in throwing [3]

National Conference on Current Trends in Engineering, Science and Technology (NACCTEST- 2018)
 Organized by GF's Godavari College of Engineering, Jalgaon
International Journal of Innovations in Engineering and Science, Special Conference Issue, 2018
 www.ijies.net

3. Shaping: while shaping the clay pot, hands are your best tool to form the shape of your pottery. In this process, outside fingers above inside fingers, press slowly in and up. To shape out: inside fingers above outside, press slowly out and up. Use a rib to refine and smooth curves, also to remove water from surface. Finish: Trim rim to level. Trim excess clay at base. For bowls leave clay at base to support walls. Pull string under base. With more experience you can use different tools like a kidney tool to shape. When you shape a pottery, you want to be sure to always support the clay by having one hand on the outside and one hand supporting the inside. [1, 2, 3]



Fig. 4- Shaping process in throwing [3]

From every potter, maximum productivity is expected and he should be able to meet with the demands of clay pot or ceramics, whether a manual or paddle operated wheel is in use. As per the need of consumer, the potter must be able to reasonably launch the product in the market. It must be up and doing especially with difficult environment a potter has encountered. Whether a throwing profile and tools for earthen pot on potter's wheel is in use instead of potter's hands, maximum productivity is required. The development of throwing profile and tools for earthen pot on potter's wheel for the potters is to increase the production and develop the interest to form an earthen or clay pot.

CONCEPT

Introducing throwing profile and tools on the potter's wheel is to overcome problem of newcomer potters or any user. In the new throwing profile and tools, there are a number of uncertain factors such as rack and pinion, for the movement of the profile and tools, as well as gearing system for the rotation of the tools or plunger. While using this throwing profile and tools, the every clay or earthen pot are the same size and shape and also maintain the thickness of the pot as well as good finishing the product than the existing. Throwing profile and the tools on the potter's wheel increases the production in the pottery.

The concept of the work is to

1. Observe using throwing tools on the potter's wheel to identify importance as it to form a clay pot.
2. Develop a throwing profile and tools for making of clay ware on potter's wheel which maintains the shape, size and the thickness of the ware.
3. Reduce the efforts of the potter so that even unskilled potter can do this.
4. The throwing profile and tools for making of clay ware on potter's wheel has specialization like accuracy, efficiency, time saving and mass production it offers.

LITERATURE REVIEW

Throwing is the one of the technique of making an earthen or clay ware on a pottery wheel. Making of an earthen or clay ware on the electric pottery wheels is faster. Today, a manual wheel, called a Kick wheel can be used. They used to make wares from speeding up the process of coiling before moving to the method we know as throwing which is used today. Throwing on the potter's wheel to make clay objects was developed at least as early as 3500 BC. This involves centring a ball of clay on a table that is turned by kicking a weighted wheel, or operating a treadle. The form is shaped by the potter's hands, but is perfectly symmetrical, because of the turning of the wheel as he shapes the clay. Throwing is the process most commonly used today for handmade earthen or clay ware. This technique is very much mechanical and wheel that is mainly used for making pots is used. The wheel has very different models and sizes. The potter's wheel rotates and the speed of the wheel can be regulated from time to time to the stage of production. A lot of patience and determination must be maintained at the time of using this technique. The potter's wheel can be used for mass production, and it is employed to make individual pieces. Potter's wheel

National Conference on Current Trends in Engineering, Science and Technology (NACCTEST- 2018)
 Organized by GF's Godavari College of Engineering, Jalgaon
International Journal of Innovations in Engineering and Science, Special Conference Issue, 2018
 www.ijies.net

work takes a lot of technical ability, but a skilled potter can produce many virtually identical plates, vases or bowls in a day. By using potter's wheel work can be used to make items with radial symmetry on a vertical axis. Throwing process on the potter's wheel was introduced to increase the number of the populace and the capacity of producing more ware produced as compared to the earlier traditional method. Throwing process on the potter's wheel is more used today, because of the accuracy, efficiency, time saving and mass production it offers.[4, 5]

Throwing varies considerably from the other shaping techniques due to the consistency of the clay and the use of a potter's wheel. Throwing consists of working a body of clay on a spinning wheel, while taking advantage of centrifugal force to shape the clay. The potter's wheel can take many forms, but generally consists of two wheels: the first wheel spins and serves as a workspace, the second wheel stores momentum and transfers it to the first. In order to work the clay while it is spinning, it requires that the clay be pliable and very plastic. Because of this, thrown clays tend to be finer, and are mixed with more water to attain the proper consistency. One of the difficulties with throwing clay involves centering the starting material; otherwise the pottery will turn out asymmetric.[6]

The shaping and formation of ceramics is one of the most technically demanding steps in production. From the perspective of modern ceramics, the physical moulding and shaping of material is a complicated process where the chemical and physical properties of the source materials can generate flaws and heterogeneities in the finished product. For example, in precision designed components tolerances will be ruined if there is improper packing of material that leads to variations in density and material thickness. Even simply sticking to the mould will ruin a cast object. In traditional ceramics no aspect of production is precision based, allowing minor flaws and variations to have no appreciable effect on the overall functionality of the object. If a pot is formed asymmetrically, while it may potentially be aesthetically unpleasing, it will be just as functional as a symmetric one. The difficulty comes from the skill needed to manipulate the clay into a form that is not only functional but that is also capable of surviving drying and firing. For example thick layers may provide more structural support while the clay is drying, but they can lead to cracking because of differential drying rates between the exterior and

interior. The techniques utilized in the formation of modern and traditional ceramics highlight aspects of production that are critical to each [6,7].

The pottery industries is a growing concern that the making of an earthen or clay ware is in the path of extinction. Our main project is to revive the dying industry. This product is needed to justifying the work of the potters with the survey. It is identified that the earthen or clay ware making machine has the capacity to produce the earthen or clay pot. To bring needed attention to the subject of product design and enable researchers to better investigate design issues, the author introduces a conceptual model and several propositions that describe how the form of product relates to consumer responses. With literature survey and field visits, different pottery techniques and process involved in pottery making techniques are understood. With the knowledge acquired, basic requirement list that the product must prepare. Different concept is made and evaluate, the main aim of this work is to focus on the customer requirements, detailed design of the product by using CAD/CAM software and analysis.[8, 9 10]

In the pottery, making of an earthen or clay pot by finger movements, with the both shared finger movements common among potters and on unique earthen or clay ware making procedures developed by each maker. In pottery, making of an earthen or clay ware as a community-based technology (CBT) that creates commodities necessary for people's needs, and consider how earthen or clay ware makers create new sizes and shapes of pots based on two-way relationships between users' demands and makers' trials and errors. Describing in the making of an earthen or clay ware process by (1) analyzing the fine movement of potter's hands and fingers, (2) identifying each maker's pot-formation processes, and (3) analyzing the process of creating new shapes of earthen or clay ware focusing on relationships between potters and users. Observations and analysis revealed four main characteristics. First, found that in the Ari pottery maker's exhibit 20 patterns of common finger movements and follow four stages in making earthen or clay pots. Second, observations focused on finger movement patterns showed that each maker develops a different procedure to make an earthen or clay pots. Variations in pottery making are related to the weight and thickness of each pot and the customer's evaluation of the durability of the pots. Third, each potter follows his/her own procedure in forming pots. Finally, potters may invent new finger movement patterns (FMPs) to create new sizes and shapes for pots to accommodate orders by preferred customers. Pottery

National Conference on Current Trends in Engineering, Science and Technology (NACCTEST- 2018)
Organized by GF's Godavari College of Engineering, Jalgaon
International Journal of Innovations in Engineering and Science, Special Conference Issue, 2018
www.ijies.net

making in the Ari area is one aspect of Ari society, and potters have developed their pottery making techniques on the basis of social relationships.

In the pottery making industry, an earthen or clay ware is done by fine finger movements with a focus on both finger movements common among potters and unique pot making procedures is developed by each potters. The idea of "techniques of the body" studies on body techniques involving physical and material constraints and utilitarian efficiency. Such as those involved in forming pots, washing clothes, and resting, have not developed as much as studies of body technique used as communication tools. They examined pottery making by analyzing potter's finger movements as a "technique of the body" among a group of them.[11]

RESEARCH METHODOLOGY

According to related literature review, we collect required data for development of mechanism for making of an earthen pot by throwing profile and tools technique on the potter's wheel. The mechanism consider all aspect of the earthen or clay ware output like, throwing profile and tools, ware stability, outside ware support, consistency of blank size, and forming force. From all these points of view, we are trying to develop such a mechanism for throwing profile and tools on the potter's wheel. The first of all the design consideration for these mechanism parameters throwing steps is most important for us. The first step of throwing process is centering, the maintained centre force on the clay as well as on potter's wheel. The second step of throwing process is open up or drawing up, to design a tool on vertical direction force from inner side and outer side to support develop profile for opening of the clay. The third and most important step of throwing process is shaping, to design a profile as per the required shape to the wares on the potter's wheel. From all above consideration to be design throwing profile and tools for making of an earthen or clay ware on the potter's wheel.

TO COMPARE WITH HANDMADE WARE ON THE POTTER'S WHEEL AND TO DESIGN THROWING PROFILE AND TOOLS

To observe both the techniques of earthen ware making process on the potter's wheel, the potter's making of an earthen ware by hands needs only those who are skilled in the particular field of the earthen ware making

process. But the throwing profile and tools used, even unskilled user can make the earthen ware. In the potters making earthen or clay ware by hands size, shape and the thickness of the clay ware is not maintained. By the use of throwing profile and tools, every earthen or clay ware is of same size, shape and thickness. Also finishing is better than the traditional technique or existing technique. The use of throwing profile and tools technique leads to the increasing production in the pottery.

CONCLUSION

Just like vertical machine like drilling or pressing machine that has both the manual throwing and the throwing by profile and tools, and user are mostly advised to learn how to work on it. This advice is essential because the throwing profile and tools on potter's wheel making an earthen or clay ware no matter how excellent they feel, do not enable a learner the opportunity to know some basic working principles of a throwing on the potter's wheel by hands, thereby brain washing the learner and earthen or clay ware makes it nearly impossible to works on the manual throwing one when the throwing profile and tools process is not available. Pottery industry where the manual throwing is only used and also pottery where throwing profile and tools used shows that:

- I. Potters that learnt the throwing process with the manual and got well acquainted with it are more hard working and more productive than potters that dwell only on throwing profile and tools on the potter's wheels.
- II. Potters that work by manual throwing on potter's wheel have gotten to know the working principles of the potter's wheel and when given the opportunity to use throwing profile and tools on the potter's wheel, handle it more professionally and more productively.
- III. Using the throwing profile and tools on the potter's wheel works brain washes and results unproductively. This is so because for a potter that is not used to the manual throwing on the potter's wheel, he or she becomes lazy and develops apathy to work.
- IV. Due to the throwing profile and tools on the potter's wheel, it takes time to get used to working on it and also does not require greater skill.

National Conference on Current Trends in Engineering, Science and Technology (NACCTEST- 2018)
Organized by GF's Godavari College of Engineering, Jalgaon
International Journal of Innovations in Engineering and Science, Special Conference Issue, 2018
www.ijies.net

REFERENCES

- [1] <http://www.bigceramicstore.com/info/ceramics/tips/intro-to-wheel-throwing-.html>
- [2] <https://ceramicartsnetwork.org/daily/clay-tools/making-clay-tools/making-multiples-using-templates-to-throw-uniform-shapes-on-the-pottery-wheel/?floater=99>
- [3] <https://www.thespruce.com/how-to-open-clay-while-throwing-2745817>
- [4] Okewu Ebute Jonathan, "Manual Potter's Wheel Efficiency in Ceramics Production in Nigeria" *IOSR Journal of Humanities and Social Science (IOSR-JHSS) Volume 19, Issue 2, Ver. V (Feb. 2014), PP 01-05 e-ISSN: 2279-0837, p-ISSN: 2279-0845.*
- [5] Nandkishor M. Sawai, Dr. V. G. Arajpure, Dr. C. C. Handa, "Potter's Wheel Efficiency in Clay Pot Production in Rural Area: A Critical Review", *International Journal of Advance Electronics & Communication System Approved by CSIR NISCAIR ISSN No. 2277-7318 Proceeding of National Conference on Current Trends in Engineering, Science, Technology and Management (NACCTESTM-2017), 21st March 2017, Godavari College of Engineering, Jalgaon.*
- [6] Prudence M. Rice, *Pottery Analysis: A Sourcebook, 2nd edition University of Chicago Press, Chicago, IL, 2015. 561 pp.*
- [7] Richerson, David W. *Modern Ceramic Engineering: Properties, Processing, and Use in Design 2nd Edition, Revised and Expanded. Marcel Dekker, Inc1992.*
- [8] R. R. Shrirao, Dr. C. C. Handa and Nandkishor M. Sawai, "Methodology for Production of Earthen Pot Profile Making – A Review" *IJSRD Vol. 2, Issue 03, 2014/ ISSN (online): 2321-0613.*
- [9] R. R. Shrirao, Dr. C. C. Handa and Nandkishor M. Sawai, "Design of Mechanism for Specific Profile on Earthen Pot Making" *IJRST Vol. 1, Issue 7, December 2014/ ISSN (online): 2349-6010.*
- [10] Mr. G.Sudhakar Mr. Mirza Hyder Ali Baig And Dr. K.Prahlad Rao, "Design And Development Of A Pottery Making Machine By Using New Product Design And Development Techniques",
- [11] Morie Kaneko, "Variations in Pottery Making in Southwestern Ethiopia", *Proceedings of the 16th International Conference of Ethiopian Studies, ed. by Svein Ege, Harald Aspen, Birhanu Teferra and Shiferaw Bekele, Trondheim 2009.*

National Conference on Current Trends in Engineering, Science and Technology (NACCTEST- 2018)
 Organized by GF's Godavari College of Engineering, Jalgaon
International Journal of Innovations in Engineering and Science, Special Conference Issue, 2018
 www.ijies.net

Investigation of MPFI System using Magnetism for Petrol Engine Enhancement

Nilesh T. Waykole¹, Tushar A. Koli², Dr. Vijay H. Patil³

¹ P.G. Student,

Thermal Engineering, G.F's Godavari College of Engineering, Jalgaon, India, 425003

² Assistant Professor,

Mechanical Engineering, G.F's Godavari College of Engineering, Jalgaon, India, 425003

³ Asso. Professor and Head of Department

Mechanical Engineering, G.F's Godavari College of Engineering, Jalgaon, India, 425003

¹ Email: -nileshtwaykole0801@gmail.com

Abstract – The prices of fuels are increasing day by day due to technological constraints, gap in the demand and supply and scarcity of conventional fuels. When fuel (Hydrocarbons) flows through magnetic emission reducer which contain strong magnetic field, change their orientation and molecule change their configuration. NdFeB magnetic emission reducer, which improves the performance of four strokes SI engine used before carburetor observed by test. Test studies include effect of NdFeB magnetic fields on fuel line, the engine performance like energy consumption and exhaust emissions. This happens because of Hydrocarbon molecules get realigned, converts para to ortho rotation hydrogen molecules and actively interlocked with oxygen during combustion to produce a near cent percent burning of fuel in combustion chamber. The current research investigates the effect of magnetic field on I.C. engines. The study concentrates on engine performance parameters such as fuel consumption and exhaust emissions. The magnetic field was applied to S.I.E. using gasoline fuel. Moreover, the fuel is subjected to a permanent magnet mounted on fuel inlet lines. The experiments were conducted at different idling engine speeds. The exhaust gas emissions of CO, NO, and CH₄ were measured by using an exhaust gas analyzer. The magnetic effect on fuel consumption reduction was up to 15%. CO reduction at all idling speed was range up to 7%. The effect on NO emission reduction at all idling speed was range up to 30%. The reduction of CH₄ at all idling speed was range up to 40%

Keywords- Fuel, Magnetic Field, Engine performance, Four stroke multi cylinder S.I. engine, Hydrocarbons,

Strong permanent magnets, Efficiency.

INTRODUCTION

The effect magnetic field on the biological and mechanical systems is the subject of study of interest from last fifty years. Many studies suggest that magnetic field has positive effect on the performance of the system. The study related to the effect of magnetic field on the fuel of I.C. engine is gaining importance in order to reduce the fuel consumption and the engine emissions. Since fuel of I.C. engine is a complex molecular arrangement of hydrocarbon as Fuel mainly consists of hydrocarbons. The simplest of hydrocarbon is methane. The chemical composition of methane is CH₄. It has the major (90%) constituent of natural gas (fuel) and an important source of hydrogen. The greatest amount of releasable energy lies in the hydrogen atom. As an example, in octane (C₈H₁₈) the carbon content of the molecule is 84.2%. When combusted, the carbon portion of the molecule will generate 28,515 KJ/Kg of carbon. On the other hand, the hydrogen, which comprises only 15.8% of the molecular weight, will generate an amazing energy- 22,825 KJ /Kg of H₂. In the present work, it is proposed to study the effect of magnetic field on the internal combustion (SI) engine.

1. EFFECT OF MAGNETIC FIELD ON FUEL MOLECULE

Hydrogen occurs in two distinct isomeric forms Para and ortho. It is characterized by the different opposite

National Conference on Current Trends in Engineering, Science and Technology (NACCTEST- 2018)
Organized by GF's Godavari College of Engineering, Jalgaon
International Journal of Innovations in Engineering and Science, Special Conference Issue, 2018
www.ijies.net

nucleus spins. The ortho state of hydrogen has more effective than para state for maximum complete combustion. The ortho state can be achieved by introducing strong magnetic field along the fuel line [5]. Hydrocarbon molecules form clusters, It has been technically possible to enhance van der Waals' discovery due to the application of the Magnetic field, a high power, permanent magnetic device strong enough to break down, i.e. de-cluster these HC associations, so maximum space acquisition for oxygen to combine with hydrocarbon.

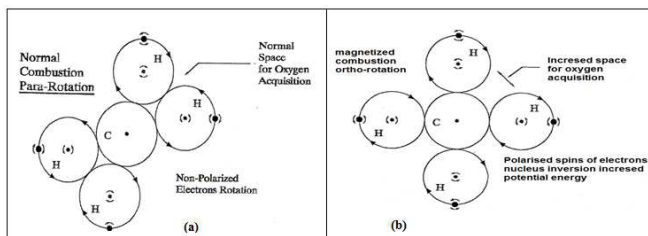

Figure 1. Schematic view of (a) Para state and (b) Ortho state of Hydrogen

Thus when the fuel flows through a magnetic field, created by the strong permanent magnets, the hydrocarbon change their orientation (para to ortho) and molecules of hydrocarbon change their configuration, at the same time inter molecular force is considerably reduced. This mechanism helps to disperse oil particles and to become finely divided. This has the effect of ensuring that the fuel actively interlocks with oxygen and producing a more complete burn in the combustion chamber. Figure.1 shows the clusters of hydrocarbons changed with the influence of magnetic field and they are more dispersed.

2. EXPERIMENTAL SET UP AND PROCEDURE

The performance tests were carried out on a three cylinder, four stroke water cooled spark ignition petrol engine. The setup consists of an engine, an eddy current dynamometer, and an exhaust gas analyzer.

The setup consists of three cylinder, four stroke, petrol (MPFI) engine connected to hydraulic dynamometer for engine loading.

Product Engine test setup 3 cylinder, 4 stroke, Petrol

Engine Make Maruti, Model Maruti 800, Type 3 Cylinder, 4 Stroke, Petrol (MPFI), water cooled, Power 27.6Kw at 5000 rpm, Torque 59 NM at 2500rpm, stroke 72 mm, bore 66.5mm, 796 cc, CR 9.2

Dynamometer Type Hydraulic

Propeller shaft With universal joints

Air box M S fabricated with orifice meter and manometer

Fuel tank Capacity 15 lit with glass fuel metering column

Calorimeter Type Pipe in pipe

Temperature sensor Thermocouple, Type K

Temperature Indicator Digital, multi channel with selector switch

Speed indicator Digital with non contact type speed sensor

Load sensor Load cell, type strain gauge, range 0-50 Kg

Load indicator Digital, Range 0-50 Kg, Supply 230VAC

Rota-meter Engine cooling 100-1000 LPH; Calorimeter 25-250 LPH

Pump Type Monoblock

Overall dimensions W 2000 x D 2750 x H 1750 mm

Water supply Continuous, clean and soft water supply @ 4000 LPH, at 10 m. head.

Provide tap with 1" BSP size connection

Space 3500Lx4000Wx2000H in mm

Drain Provide suitable drain arrangement (Drain pipe 65 NB/2.5" size)

Exhaust Provide suitable exhaust arrangement (Exhaust pipe 32 NB/1.25" size)

Fuel, oil Petrol @ 10 liter

Oil @ 3.5 lit. (20W40)

National Conference on Current Trends in Engineering, Science and Technology (NACCTEST- 2018)
Organized by GF's Godavari College of Engineering, Jalgaon
International Journal of Innovations in Engineering and Science, Special Conference Issue, 2018
www.ijies.net

The setup has stand-alone type independent panel box consisting of air box, fuel tank, manometer, fuel measuring unit, digital speed indicator and digital temperature indicator. Engine jacket cooling water inlet, outlet and calorimeter temperature is displayed on temperature indicator. Rota meters are provided for cooling water and calorimeter flow measurement.

The setup enables study of engine for brake power, BMEP, brake thermal efficiency, volumetric efficiency, specific fuel consumption, air fuel ratio and heat balance.

1. First the entire connections have been checked.
2. Fuel tank is filled with petrol.
3. Fuel weight measuring unit placed to ON position.
4. Cooling water pump is started.
5. Ensure cooling water circulation for hydraulic dynamometer, engine & calorimeter.
6. Start the set up and run the engine at no load for 5 minutes. Wait for few minutes till steady state is activated. Note Engine speed & load.
7. Gradually increase the load on engine by rotating dynamometer load wheel
8. Increase the engine throttle to any desired position & simultaneously load the engine to obtain desired speed for which power is to be calculated.
9. First take all the readings by gradually increasing load from 20 kg up to 32 kg. without use of any magnet ,for 100 ml. fuel.
10. Fill all the readings in observation table.
11. Gradually decrease the load.
12. For further readings with one magnet fit one magnet before injector.
13. Again increase the load gradually from 20 kg up to 32 kg with one magnet, for 100 ml fuel.
14. Fill all the readings in observation table.
15. Again gradually decrease the load.
16. For further readings with two magnets fit two magnet s before injector.
17. Fill all the readings in observation table.
18. Also fill all the readings in CO& HC Table with respective loads, rpm. & number of magnets .
19. Fill up all the observations in worksheet to get the results and performance plots.

HOW TO INSTALL

Fuel injected cars are self-adjustable, with the exception of cases when the lambda (excess air) probe has been worn out (needs replacement) and the system “overrides” this unit action. Ideally, the adjustment should be done by the professional diagnostic station, which based on the exhaust analysis will optimally adjust the engine. Without the adjustment the unit can cause the effect reverse from the required. Also, in the first intensive phase of decarburization there may be a disturbance in the engine's work and unstable fuel consumption, caused by the temporary clogging of jet nozzles by the liquidated deposits. The temporary occlusions are removed in a natural way. At that time it is not recommended to do the engine adjustment. However, during the Stabilization Period the periodic oil change is recommended. Subsequently, one has again to change oil after the Stabilization Period. Compared to savings during the exploitation of the vehicle and extending engine's life, this is a really small investment.



Fig.2- Installation of kit

National Conference on Current Trends in Engineering, Science and Technology (NACCTEST- 2018)
 Organized by GF's Godavari College of Engineering, Jalgaon
International Journal of Innovations in Engineering and Science, Special Conference Issue, 2018
 www.ijies.net

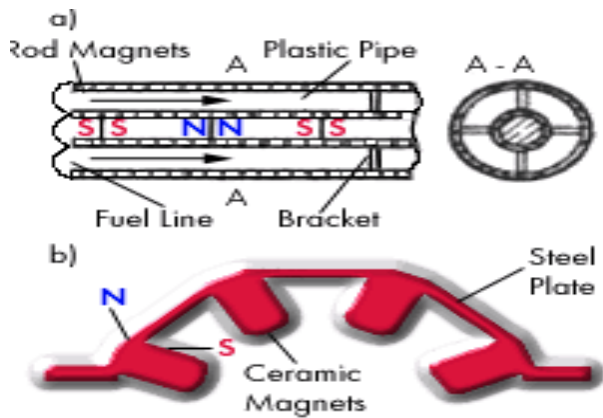

Fig. - 3

Technological and economical advantages, as well as engine performance gradually increase (as the number of driven miles/kms increases), reaching the highest effect at the end of the Stabilization Period and thereafter. The recent advent of the gas emission analyzer (regrettably not to be found in many countries where we do business!), which is used to enforce state.

SPECIFICATION OF MAGNET.

- Place of Origin: Zhejiang, China (Mainland)
- Application: Industrial Magnet
- Shape: Others (Rectangular)
- Type: Permanent.
- Composite: NdFeB Magnet.
- Brand Name: Bestway.
- Function: To save fuel & reduce emission gases.
- Produce name: Super Fuel Saver.
- Strength 2 Teslas.

OBSERVATIONS

Table 1 shows polluted emission before installation of magnetic emission reducer, without magnet at 1100 rpm

Table 1 :Polluted emission (before installation)

Sr.No.	CO(%)	HC(ppm)	CO2 (%)	NOx (ppm)
1	0.93	172	9.0	108
2	0.84	166	9.1	129
3	0.57	154	9.2	186

Table 2 shows polluted emission after installation of magnetic emission reducer, with magnet at 1100 rpm

Table 2 :Polluted emission (after installation)

Sr.No.	CO(%)	HC(ppm)	CO2 (%)	NOx (ppm)
1	0.23	133	9.0	100
2	0.23	120	8.8	97
3	0.12	96	8.6	149

Before and after installation of magnetic emission reducer Graph of emission of CO and CO2 were plotted to compare characteristics and emissions of gases in SI engine. Fig. 4 shows the graphs of emission of HC and. emission of CO2.

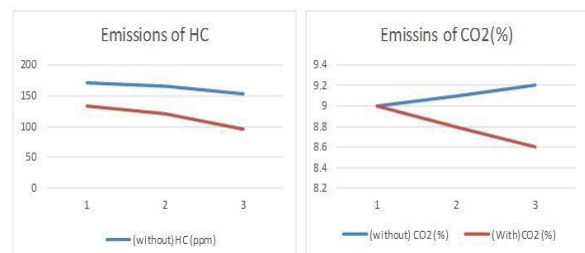

Fig 4.emission of HC and. emission of CO2.

RESULTS

An in-depth study has been conducted to comprehend the interaction between magnetic fields and fuel diffusion. In this study the influence of the gradient magnetic field on the fuel behavior was assessed by investigating the following; changes in the fuel structure i.e. the luminosity and shape, the non-dimensionless numbers governing the interaction, variation in the

National Conference on Current Trends in Engineering, Science and Technology (NACCTEST- 2018)
Organized by GF's Godavari College of Engineering, Jalgaon
International Journal of Innovations in Engineering and Science, Special Conference Issue, 2018
www.ijies.net

temperature distribution within the fuel, and morphology studies of smoke produced in these combustion. The study methodology involved collecting the requisite set of data by subjecting the fuel flow to a gradient magnetic field and comparing the data to a case of no applied magnetic field. The significant observations of this study are summarized as under:

A diffusion of fuel corresponding to flow rates 100cc was analyzed for the effect of the magnetic field on its combustion characteristics. Practical examination of the fuel deformation indicated an increase in the temperature reduce in smoke & more time for fuel burning as compared with zero magnetic field. This demonstrates the field's influence on the fuel structure. Here, the magnetic force enhances fresh air supply for the combustion of fuel burning. This is expected since fuel deformation, fuel combustion (fuel and products of combustion) being diamagnetic in nature are repelled by stronger fields and hence are turned away in directions of lower intensities. The force exerted by the magnetic field is considered to be small. The force acting on oxygen in the present study can cause changes in the fuel deformation.

A numerical study was carried out to assess the species concentration distribution and the temperature profiles (no applied magnetic field) for the flames burning in air. The temperature measurements were carried out for the flow rates and these measurements were in close agreement with the numerical predictions

CONCLUSION

This is a device for fuel processing with the purpose of its preparation (modification) for the more effective combustion in the internal-combustion engine. At its designing the necessary condition for reception of effect of decoupling fuel hydrocarbon circuits and their keeping in such condition for the period, necessary for technological process of fuel burning is considered.

The invention is related to the technical equipment where the effective utilization of fuel by internal-combustion engine and reduction of ecologically harmful exhausts at their work is required.

A number of devices for "magnetization" the liquids (fuel) are known, having the general and common purpose to pass the liquid through a magnetic

field and "to magnetize" it. Such devices have a number of lack s:

- non-technological designs
- passage of liquid past the active zone of the magnetic field
- contact of magnets with liquid
- presence of joints of details requiring hermetic sealing

The offered design has a concrete purpose. The purpose of the invention is to increase the efficiency of fuel combustion of fuel in the internal-combustion engine (petrol and diesel) with improvement of their ecological characteristics. Thus the design is compact and reliable. Processing (modification) of fuel before its reception into the combustion chamber of the internal-combustion engine, occurs in the channel of fuel pipe with to variable cross-section.

The positive effect is reached at a molecular level in a volume of the channel of fuel pipe with variable polarization by magnetic field. As elementary particle of liquid (molecule, ion) in magnetic field is influenced by Lorentz's force aspiring to turn it perpendicularly, in a volume of fuel pipe with variable polarization resonant magnetostriction effects arise, braking the hydrocarbon "chains" of fuel, leading the fuel structure to a condition in which oxidizing process at combustion proceeds much more effectively, with reduction of harmful emissions. A research at test stands a specialized design office of engines, at application of the device in system of fuel delivery of a forced automobile petrol & diesel engines.

ACKNOWLEDGMENT

I take this opportunity to express my profound gratitude to my esteemed project guide Prof. Tushar A. Koli and Dr. Vijay H. Patil H.O.D of Mechanical Engineering Department of Godavari College of Engineering, Jalgaon for his excellent guidance, suggestions and constructive criticism & for his constant support and encouragement. Working under his guidance greatly contributed in improving quality of my project work and my Engineering skills. Actually, he is one of such genuine

National Conference on Current Trends in Engineering, Science and Technology (NACCTEST- 2018)
Organized by GF's Godavari College of Engineering, Jalgaon
International Journal of Innovations in Engineering and Science, Special Conference Issue, 2018
www.ijies.net

person for whom my words will not be enough to express.

REFERENCES

- [1] P. Govindsamy, S. Dhandapani, "An Experimental Investigation on the effect of Magnetic flux to reduce emissions and improve combustion performance in a two stroke catalytic coated spark ignition engine", *KSAE International Journal of Automotive Technology*, Paper No. E. 2006079. Vol. 8, November 5, Year 2007.
- [2] S. Dhandapani, R. Manivel, "Development of an advanced electronic fuel injection system for two stroke S. I. Engine for reduction of emissions using virtual instrumentation." *International Symposium and Exposition on Automobile Electronics and Alternate energy vehicles. 23rd to 25th Nov. 2001 I. I. T., Kanpur pp 94-104*
- [3] P. Govindasamy, "An Experimental study of Magnetic Fuel conditioner in a Petrol engine using Exhaust Gas Recirculation", *The ICAFI Journal of Science and Technology*, Under Review.
- [4] N.Nedunchezhian, S. Dhandapani. "Heat release analysis of lean burn catalytic combustion in a two-stroke spark ignited engine," *International Journal of Combustion Science and Technology*, 2000 vol. 155. pp. 181-200.
- [5] P. Govindsamy, S. Dhandapani, "Magnetic Fuel conditioning for emission and Cyclic reduction in a catalytic coated two stroke gasoline engine", *Journal of Energy, Heat and Mass Transfer*, vol. 8, pp. 351-360, 2008.
- [6] S. Dhandapani, "An Experimental Investigation on Four-Stroke Multi Cylinder Petrol Engine for Fuel Reformulation through Magnetic flux to control Combustion generated emission", *Journal of Energy, Heat and Mass Transfer*, vol. 28, pp. 251-260, 2006.
- [7] www.saver.com
- [8] www.magnetimattress.com.
- [9] www.magnetizer.com.
- [10] *Internal Combustion Engine Fundamentals*. Heywood, John B McGraw-Hill
- [11] *Internal Combustion Engines: Applied Thermo sciences*, 2nd Edition, Colin R. Ferguson, Allan T. Kirkpatrick.
- [12] "Internal Combustion Engines Analysis and Practice", Obert E.F., International Text Books Co., Scranton, Pennsylvania.
- [13] "Automotive Engines", William H.Crouse McGraw-Hill.
- [14] "Automotive technology: A system approach", Erjavec, Thomson learning series.
- [15] "Heat release analysis of lean burn catalytic combustion in a four-stroke spark ignited engine." *International Journal of Combustion Science and Technology*. N. Nedunchezhian. 2000 vol.155 . pp. 181-200.
- [16] "Experimental Investigation on Electronic Fuel Injection in four- Stroke SI Engine using Virtual Instrumentation Technique", *International Journal of Engineering Education*, Robinson Y & S.Dhandapani Vol.21,2005. No.1, pp 55-62.
- [17] Investigation of pollution monitoring and its control for the Indian petrol light duty vehicles applications to meet emission regulations". *International Journal of Enviromedia* S.V.Saravanan. vol.4 pp.821-826 2006.
- [18] "An Experimental Investigation on the effect of Magnetic flux to reduce emissions and improve combustion performance in a four-stroke catalytic coated spark ignition engine", *KSAE International Journal of Automotive Technology*, Paper No. E 2006079. P.Govindasamy, S. Dhandapani Vol.8,November5,Year2007.
- [19] S.Dhandapani, P. Govindasamy "Economizer for four- stroke engine" *Motor India Auto Journal*, S.Dhandapani, P. Govindasamy Vol. 46, No.10, May2002, pp 29-31
- [20] "Experimental Investigation on Embedded system controlled Electronic Fuel Injection of LPG in a four- stroke Spark Ignited Engine" Y. Robinson, S. Dhandapani, *International Mechanical Engineering Conference and Expo 2004 (IMECE 2004)*, Dec 5-8, 2004

National Conference on Current Trends in Engineering, Science and Technology (NACCTEST- 2018)
Organized by GF's Godavari College of Engineering, Jalgaon
International Journal of Innovations in Engineering and Science, Special Conference Issue, 2018
www.ijies.net

Design and Analysis of Go-Kart Wheel Rim by Using CATIA and ANSYS

Yash Fule¹, Sopan Kadu², Akshay Amrutkar³, Hitesh Khirsagar⁴, Prof.Avinash Panchal⁵

1,2,3,4 Student

G.H.Raisoni College of Engineering And Management, Jalgaon,India

5 Assistant Professor

G.H.Raisoni College of Engineering And Management, Jalgaon,India

¹Email:- ybfule@gmail.com

Abstract – The wheel rim is vital part in the vehicle. It is firm and it gives firm base on which tire is fit. The main goal of project is to design the wheel rim of go kart vehicle using CATIA V5 and analyze this wheel rim by using ANSYS14.5. Ansys is a tool used for finding out the forces and deformation occurring in the system and structure. First the wheel rim is designed by using modeling software CATIA V5. Then the design is taken in Ansys 14.5 for analysis. The analysis is most preferred because it takes so many time for manufacturing the part and So that we made the modeling of go-kart wheel rim with the help of CATIA. We Analyze the wheel rim by taking different materials in consideration and taking forces or the pressure acting due to air pressure in the tube. The analysis gives us idea about the product that how it works and how does we can made it or it is affordable or not.

Keywords- Kart , Wheel rim, Analysis, ANSYS

1. INTRODUCTION

The wheels give firm base for the tire. The wheel rim is most important part for the vehicles as the stability of vehicle is partially depend on wheel rim. Therefore we have some idea about the rim properties such as strength, deformation, safety factor, etc.

In recent years, the process has been developed by variety of experimental and analytical methods of structural analysis is such as strain Gauge and finite element method. Within past 10 years, durability analysis (fatigue life prediction) and the method of reliability for dealing with changes. The engineering structure is applied to the automobile wheel.

Motor vehicles are produced according to very strict rule for safety purpose of the passengers. Every components are designed according to its final conditions of components. Wheels are classified as safety critical component and international codes and according to the specification which is used to design a go kart wheel.

The inside diameter of the tire must fit onto the rim, it might be impossible for the inside diameter of tire to pass over large diameter of the tire without causing damage to the beads. Forcing the beads onto rim well opposite to the fitting head of the machine during the fitting or removal process, allows the tire bead enough purchase to pass over the rim flange.

1.2 FUNCTIONS OF A WHEEL RIM

In its vital form a wheel rim is a transfer element between the tire and the vehicle. The following are the main functions of a wheel rim:

National Conference on Current Trends in Engineering, Science and Technology (NACCTEST- 2018)
Organized by GF's Godavari College of Engineering, Jalgaon
International Journal of Innovations in Engineering and Science, Special Conference Issue, 2018
www.ijies.net

- Transferring torque (braking and acceleration).
- Support mass (support the mass of the motor vehicle).
- Adds mass (damped mass for diving comfort).
- Dissipating heat (due to braking).
- Absorb Impact (road hazard).
- Conserve Energy (potential energy in momentum).

2. THEORY OF WHEELS

The tire works as a wheel only after it is set up on the rim and is inflated therefore; the tire and wheel assembly effects the function and performance of the vehicle. The tire is designed and manufactured to suit a typical rim and once installed on the correct rim the tire will perform up to its preferred level. It is unnecessary to say that the life of the tire will be reduced if it is installed on an inappropriate rim. The rim is actually the name for the cylindrical part where the tire is installed. A wheel is the name for grouping between rim and disc plate. Once the disc plate is fixed inside the cylinder this assembly becomes a wheel.

2.1 Rim Nomenclature

- 1. Wheel:** Wheel is generally composed of rim and disc.
- 2. Rim:** This is the part where tire is installed.
- 3. Disc:** This is the part of the rim where it is fixed to the axle hub.
- 4. Offset:** This is the space between wheel mounting surface where it is bolted to hub and Centre line of rim.

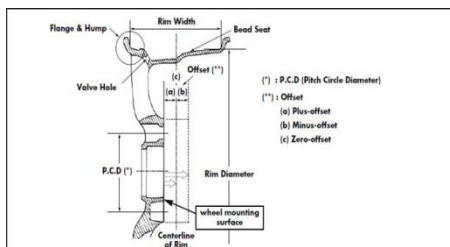

Fig. Wheel Rim 2D

- 5. Flange:** The flange is part of rim which hold both beds of the tire.

6. Bead Seat: Bead seat approaches in contact with bead face and it is part rim which hold the tire in a radial direction.

7. Hump: It is a bump that was put on the bed seat for the bead to prevent the tire from sliding off the rim while vehicle is moving.

8. Well: This is a part of rim with depth and width to facilitate tire mounting and removal from the rim

3. TYPES OF WHEEL RIM/WHEELS

Car wheels are divided in to two main categories steel wheels and alloy wheels. Alloy wheels are often fitted standard during the manufacturing of modern vehicles.

3.1 STEEL WHEELS

All steel wheels consist of two pressed components, the rim and the wheel disc, which are welded together. The rim is the part on which tyre is mounted. Its dimensions shape and condition must suitable to satisfactorily accommodate the particular tyre required for the vehicle. The wheel disc is the supporting member between the vehicles hub and the rim. Its dimensions shape and location in the rim must be suited to the design of the wheel hub and the suspension geometry of the vehicle to which it has to be mounted. The purpose of the rim is to provide a firm base on which to fit the tyre. Four vital dimensions are involved.

They are the wheel diameter (a precise fit between tyre and rim is of utmost importance), the rim width, the flange height (designed to give adequate support to the tyre beads without changing the flux area of the side wall) and the rim-well (to facilitate the easy mounting and demounting of the tyres).

Because the inside diameter of the tyre must fit precisely onto the rim, it would be impossible for the inside diameter of the tyre to pass over the large diameter of the tyre rim without causing damage to the beads. Forcing the tyre bead into the rim well opposite to the fitting head of the machine during the fitting or removal process, allows the tyre bead enough purchase to pass over the rim flange.

National Conference on Current Trends in Engineering, Science and Technology (NACCTEST- 2018)
 Organized by GF's Godavari College of Engineering, Jalgaon
International Journal of Innovations in Engineering and Science, Special Conference Issue, 2018
 www.ijies.net



Fig. STEEL DISC

3.2 ALLOY WHEELS

Alloy wheel is often incorrectly referred to as magnesium or “Mag” wheels. Magnesium is used in alloys. Whereas, they are almost found only in racing rims meant for the track. Its brittle also highly flammable qualities make it unsuited as a road rim. Lower pressure, die-casted aluminum alloy wheel is used and provide certain benefits over steel wheel. It is possible to design alloy wheel that alloy for the better air flow over the brakes and that are also slightly lighter as well as visually more attractive than steel wheel. Since alloy is lighter than steel, wider rims can be used without sacrificing unsprung weight.



Fig. ALUMINIUM ALLOY WHEEL

4. TYPES OF MATERIAL USED FOR WHEEL RIM DESIGNING:

In designing go kart wheel rim we use 3 materials these are as follows:

1. Aluminum Alloy
2. Magnesium Alloy
3. Forged Steel

The properties of the materials are as follows:

1. Aluminum Alloy:

Table 1: Properties of Aluminium Alloy

Density	2.77e-009 tonne mm ⁻³
Coefficient of Thermal Expansion	2.3e-005 C ⁻¹
Specific Heat	8.75e+008 mJ tonne ⁻¹ C ⁻¹
Tensile Ultimate Strength MPa	310
Tensile Yield Strength MPa	280

2. Magnesium Alloy:

Table 2: Properties of Magnesium Alloy

Density	1.8e-009 tonne mm ⁻³
Coefficient of Thermal Expansion	2.6e-005 C ⁻¹
Specific Heat	1.024e+009 mJ tonne ⁻¹ C ⁻¹
Thermal Conductivity	0.156 W mm ⁻¹ C ⁻¹
Resistivity	7.7e-004 ohm mm
Tensile Yield Strength MPa	193
Tensile Ultimate Strength MPa	255

3. Forged Steel:

Table 3: Properties of Forged Steel

Density	7.6e-009 tonne mm ⁻³
Coefficient of Thermal Expansion	1.2e-005 C ⁻¹

National Conference on Current Trends in Engineering, Science and Technology (NACCTEST- 2018)
 Organized by GF's Godavari College of Engineering, Jalgaon
International Journal of Innovations in Engineering and Science, Special Conference Issue, 2018
 www.ijies.net

Specific Heat	4.34e+008 mJ tonne ⁻¹ C ⁻¹
Thermal Conductivity	6.05e-002 W mm ⁻¹ C ⁻¹
Resistivity	1.7e-004 ohm mm
Tensile Yield Strength MPa	550
Tensile Ultimate Strength MPa	850

5. STEPS INVOLVED IN DESIGNING GO KART WHEEL RIM BY USING CATIA V5

1. Draw rim sketch in sketcher catia as follow

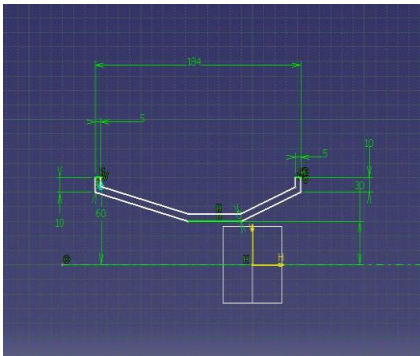

2. Then used shaft command for revolving sketch

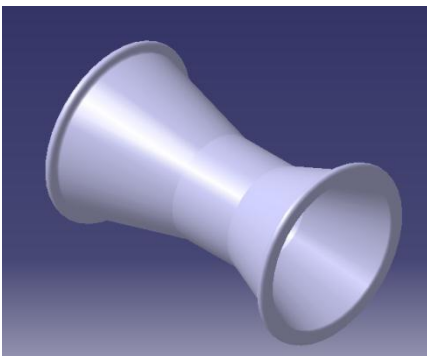

3. Then Project inner mounting in sketch and pad it.

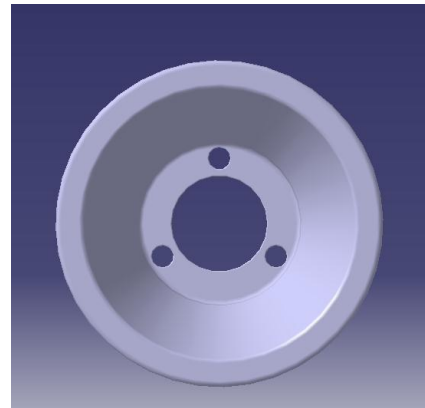

6. MESHING AND BOUNDARY CONDITIONS OF RIM IN ANSYS 14.4

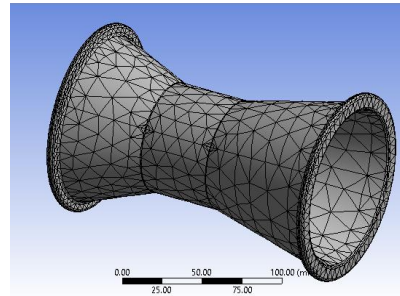

Fig. Mesh Model

The part has following configuration.

Elements	22918
Nodes	12546

Table: Nodes and Elements of Rim

The Boundary Conditions Of the rim is as follows:-

The Pressure is 15 psi is applied on the rim.

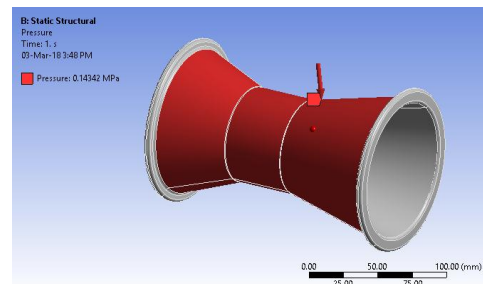

Fig. Applied Pressure

National Conference on Current Trends in Engineering, Science and Technology (NACCTEST- 2018)
 Organized by GF's Godavari College of Engineering, Jalgaon
International Journal of Innovations in Engineering and Science, Special Conference Issue, 2018
 www.ijies.net

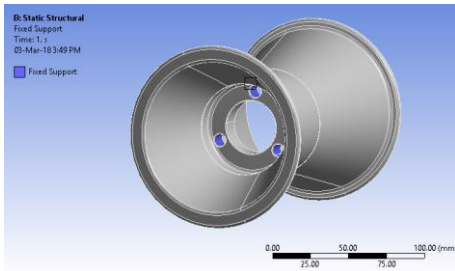

Fig. Fixed Support

The Force is 1800 N is applied on the rim

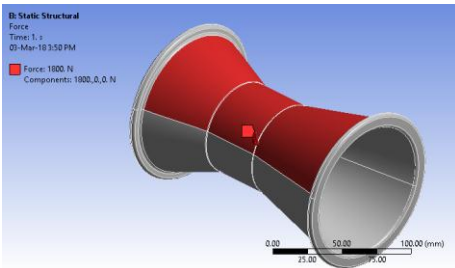

Fig. Applied Force

7. RESULTS OF ANALYSIS ON GO-KART WHEEL RIM:

We use ansys 14.5 for analysis of go-kart wheel rim by using different types of materials. The results of these analysis are as follows:-

7.1 Aluminum Alloy:

The deformation occurs in the wheel rim is 0.0233 mm.

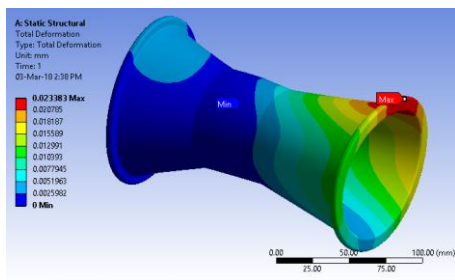

Fig. Deformation of rim

The equivalent stress in the wheel rim is 40.89 MPa

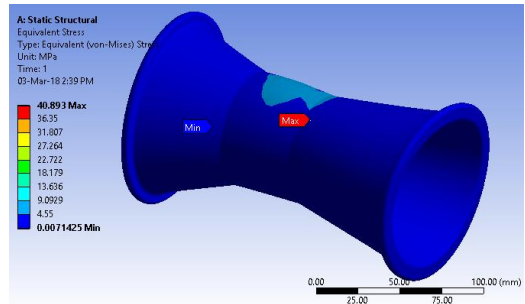

Fig. Equivalent Stress

The factor of safety of the wheel rim is 6.8471.

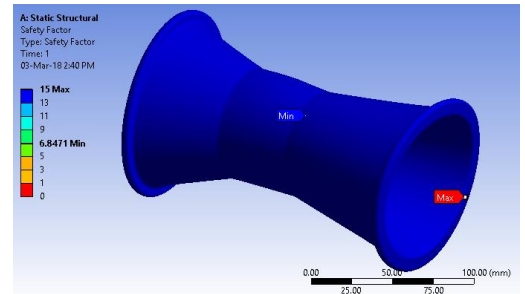

Fig. Factor Of Safety

FOS = Maximum stress/Working stress

$$FOS = 280/40.89$$

$$FOS = 6.8476$$

7.2 Magnesium Alloy:

The deformation occurs in the wheel rim is 0.03696 mm.

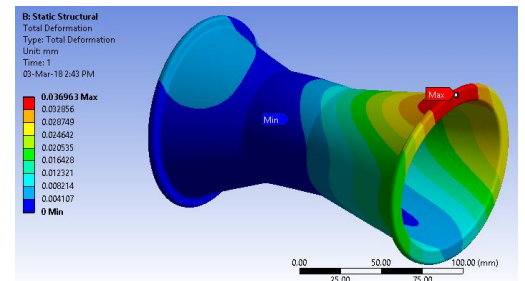

Fig. Deformation of rim

The equivalent stress in the wheel rim is 40.409 MPa

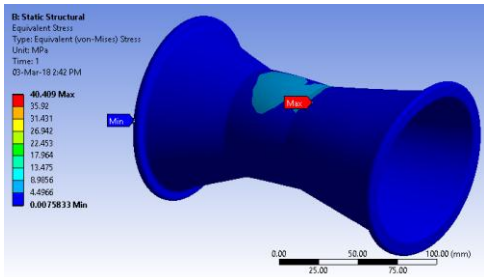

Fig. Equivalent Stress

The factor of safety of the wheel rim is 4.7762.

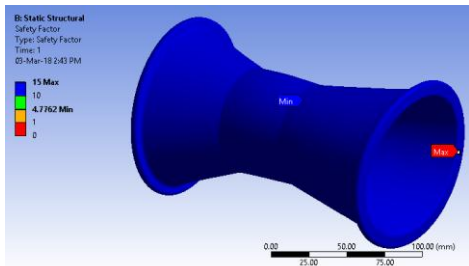

Fig. Factor Of Safety

FOS = Maximum stress/Working stress

$$FOS = 193/40.409$$

$$FOS = 4.776$$

7.3 Forged Steel:

The deformation occurs in the wheel rim is 0.007878 mm.

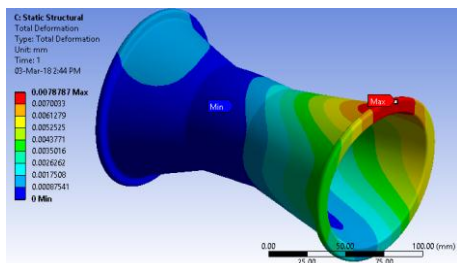

Fig. Deformation of rim

The equivalent stress in the wheel rim is 41.586 MPa

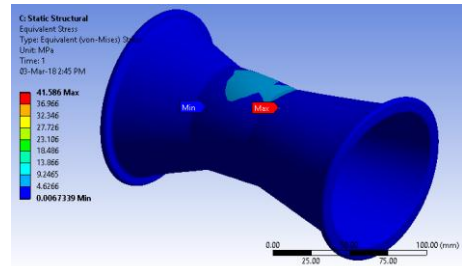

Fig. Equivalent Stress

The factor of safety of the wheel rim is 13.227.

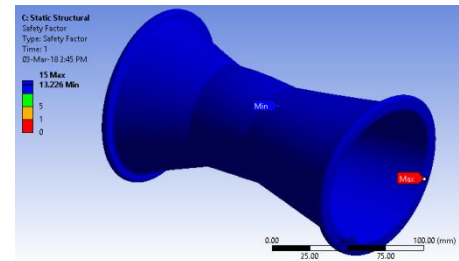

Fig. Factor Of Safety

FOS = Maximum stress/Working stress

$$FOS = 550/41.586$$

$$FOS = 13.226$$

8. CONCLUSION

1. According to our analysis we found that the deformation due to the load/pressure of the tire and tube in the forged steel is minimum than aluminum alloy and magnesium alloy.

For the deformation of wheel rim, we are follow relation given below:

Forged Steel > Aluminum Alloy > Magnesium Alloy

2. The cost of the forged steel is greater than that of aluminum alloy and also of magnesium alloy. The forged steel has greater Strength but has high cost than aluminum alloy.

Aluminum Alloy > Forged Steel > Magnesium Alloy

We overall conclude that the aluminum alloy is mostly preferred for the wheel rim because it has low cost and it also has good strength. Forged steel has high cost.

National Conference on Current Trends in Engineering, Science and Technology (NACCTEST- 2018)
Organized by GF's Godavari College of Engineering, Jalgaon
International Journal of Innovations in Engineering and Science, Special Conference Issue, 2018
www.ijies.net

Magnesium alloy has strength between aluminum alloy and forged steel.

Table 4: Comparison of the results

Material	Deformation	Equivalent Stress	Factor of Safety
Aluminum Alloy	0.0233 mm	40.89 MPa	6.8476
Magnesium Alloy	0.0369 mm	40.409 Mpa	4.776
Forged Steel	0.007878 mm	41.586 Mpa	13.227

9. REFERENCES

- [1] Mizoguchi, T., Nishimura, H., Nakata, K., and Kawakami, J., 1982, "Stress analysis and Fatigue Strength Evaluation of Sheet Fabricated 2-Piece Aluminum alloy Wheels for Passenger cars" R&D, Research & Development (Kobe Steel, LTD), Vol.32, n 2, pp., 25-28.
- [2] Resiner, M., and DeVries, R., "Finite Element Analysis and Structural optimization of vehicle wheels," SAE Technical Paper Series, 1983.
- [3] Hoemson, R., "Structural Design of Agricultural Wheels," American Society of Agricultural Engineers.
- [4] Lawrence, G. and Miller, P., "Wheel Materials," SAE technical publications 1988.
- [5] Fatigue Analysis of Aluminum Alloy Wheel Under Radial Load, International Journal of Mechanical and Industrial Engineering (IJMIE), ISSN No. 2231-6477, Vol-2, Issue-1, 2012.
- [6] "An analysis of stress and displacement distribution in a rotating rim subjected to pressure and radial loads" by P.C.Lam and T.S.Srivastam.
- [7] THE TIRE AND RIM ASSOCIATION, INC (1996), "50 Drop Centre Rim Contours", J (ISO) Contour for 14,15,16,18 and 20 diameter Designation, pp7.05.
- [8] Stress Analysis Of Wheel Rim International Journal of Mechanical Engineering and Research Volume 1 Issue 4.

National Conference on Current Trends in Engineering, Science and Technology (NACCTEST- 2018)
Organized by GF's Godavari College of Engineering, Jalgaon
International Journal of Innovations in Engineering and Science, Special Conference Issue, 2018
www.ijies.net

A Review on Hill Descend Control System for Vehicle

Salunke Rahul Prabhakar¹, Chaudhari Homraj Ashok², Patil Mahendra Shantaram³, Valvi Sharad Surupsing⁴, Chandankar Pradnya Milind⁵, Prof. M.P.Thakur⁶

^{1,2,3,4,5}B.E. Student

GF'S Godavari College Of Engineering Jalgaon, India, 425003

⁶ Assistant Professor

Department of Mechanical Engineering GF'S Godavari College Of Engineering Jalgaon, India 425003

¹Email:- rahulsalunke1202@gmail.com

Abstract – The objective of this topic is to study hill descend controlled system in vehicle. Hill assist is an automatic system that operate break to stop rolling back when it is starting on sleep hill. When hill assist system senses vehicle is starting from rest on slop, it automatically keeps food break even after you released the pedal by accelerated vehicle using parking break/hand break. The hill descent controlled system help to increased controlled on sleep grades and prevent from rolling back. Another function is hill hold function which is highly desirable feature in manual transmission vehicle equipped with hybrid powers train. The hill hold feature supports the stop and go performance associated by holding the vehicle on an inclient and preventing undesired motion.

Keywords- Hill Assist Control, Hill Starts Assist Control, Hill Hold Control.

INTRODUCTION

The mechanism is used in many applications effectively where the one side power transmission is required for example in (I) Giant wheel-It is the large wheel used in the amusement parks to rotate along the horizontal axis to rotate in one direction while carrying the number of passengers. (ii) Clock where the hands rotate in clockwise directions only. (iii) Baffle gates in the entrances of many buildings which rotate about vertical axis in one direction. (iv) Shaping Machines in

the crank and slotted arm. In the hill station, the most common problem to the drivers is to park their cars in the slope and to start up the car. While waiting in the traffic, the cars have to move on step by step very slowly; this situation is difficult one for the drivers to make their car not to roll back in the slope. So the mechanism haste be developed to stop the vehicle from rolling back and it should not stop the vehicle in accelerating forwards. This function can be achieved by using thatched and pawl mechanism. The ratchet and pawl has to be designed and has to be fit in the front drive shaft in case of the front drive vehicles. The Marti Swift Dire car is considered and the ratchet and pawl has to be designed for it. In order to design for the worst case the road maximum slope is considered Zoji pass Road Kashmir which has 21.80 with gradient 2/5.



Fig. 1- Schematic representation of operating the brake)

clutch and accelerator simultaneously it is not advisable to use the hand

Brakes while the car is moving in forward movement.

National Conference on Current Trends in Engineering, Science and Technology (NACCTEST- 2018)
 Organized by GF's Godavari College of Engineering, Jalgaon
International Journal of Innovations in Engineering and Science, Special Conference Issue, 2018
 www.ijies.net

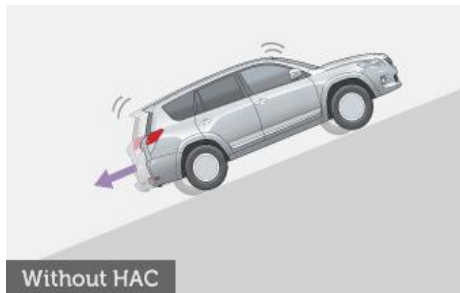

Fig. 2-Ac hill start Assist control

Without the HAC system, backward rolling or slippage occurs in steep inclines. As the system is not available the vehicle start to roll backward when ever the brake release or the forward engine power is absent. The slipping of vehicle in back side also a very awkward condition for driver as he has to, manage clutch and brake with accelerator simultaneously.

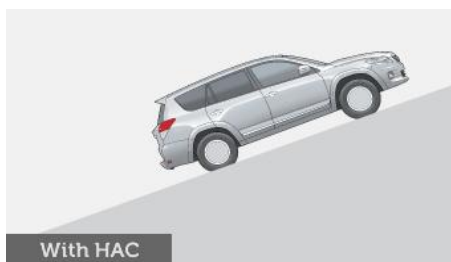

Fig. 3-individual wheels from locking

The HAC system helps increase control on steep upgrades and prevents individual wheels from locking. As the hold system is enable the vehicle will be stand still without any brake is applied when ever forward power is applied the vehicle will move in forward only. There will be no awkward driver situation in driving .so the slip and roll of vehicle is completely absent.

LITERATURE SURVEY

A. Anti-creep and hill holder brake system
 Cook George suggested a hill holder mechanism holds the vehicle in slope for 2 seconds by using the brake pressure. A device operable in a transmission of a vehicle for substantially preventing vehicular rollback on an incline, comprising: a shaft rotatable which is supported in a transmission housing; a gear selectively connected for common rotation with the shaft, wherein the gear is rotatable in a first rotary direction and a second rotary direction. B. Improved release mechanism

for a hill holder device William kent utilized a load sensor connected with a wheel brake to sense a change in wheel braking torque and communicate responsively with a mechanical brake control device. If a car is stopped on an incline while the motor is still running, there's a good chance that some kind of hill-start control will be needed. A sensor that detects an incline of more than a certain amount, three degrees or more, can send a signal to the hill-start control indicating that the vehicle has the potential to start rolling. The disadvantage of incline detection is that sometimes a car maybe on an incline without needing the hill-start control - for instance, when a tire slips into a pothole. C. Improved release mechanism for a hill holder device Grzegorz Janiszewski stated that the use of piston cylinder device, controlled by an electronic unit which is coupled to a hydraulic pressure system and acts on the brake pedal for two seconds. D. Release mechanism for a hill holder device William K. Messersmith used the load cell with electrical control for braking system. But it requires continuous electric energy for the production and display of signals. It also requires an amplification circuit for the generation of output display because the signals produced by the gauge itself are of very much low voltage almost in milli-volts. In a vehicle having a clutch pedal and a brake pedal, a hill holder device is utilized to maintain the brake pedal in the applied position so that the vehicle operator's foot is free to operate the accelerator pedal. A mechanical brake control device may be disposed between the clutch and brake pedals, with the clutch pedal connected by a linkage to the brake control device so that release of the clutch pedal will cause deactivation of the brake control device and result in release of the brake pedal from the applied position. The release mechanism should be usable with either a mechanical brake control device or a braking assistance servo-motor system. E. Vehicle transmission hill holder Alvin H. Berger used a one-way clutch when engaged it prevents rolling of the vehicle. A device operable in a transmission for substantially preventing vehicular rollback on an incline includes a shaft, a gear, a one-way clutch, and a pawl member. The gear is selectively connected for common rotation with the shaft. The gear is rotatable in a first rotary direction and a second rotary direction. The one-way clutch has an inner race and an outer race, where the inner race is connected to the gear and the outer race has an outer surface having a plurality of engaging teeth. The pawl member has a first end and a second end, where the first end is pivotal mounted to a

National Conference on Current Trends in Engineering, Science and Technology (NACCTEST- 2018)
Organized by GF's Godavari College of Engineering, Jalgaon
International Journal of Innovations in Engineering and Science, Special Conference Issue, 2018
www.ijies.net

transmission housing. The second end of the pawl has a first angled portion configured to release and engage at least one of the plurality of engaging teeth of the outer race as the outer race rotates in the second rotary direction. The current invention is a mechanical assembly applicable to convert bidirectional motion of an input shaft into unidirectional motion of an output shaft comprising input shaft, intermediate shaft and output shaft, wherein two sets of gearing arranged one after the other, in combination with ratchet and pawl mechanisms driven in opposite directions, with two opposing ratchet wheels fitted to input shaft, each accompanied by a gear wheel driven on bearings on the same shaft with protruded flanges integral to aforesaid gear wheel, carrying spring loaded pawl on flanges to engage with accompanied ratchet wheel. Ratchet and pawl mechanism is used in many applications effectively where the one side power transmission is required for example in

(i) **Giant wheel**- It is the large wheel used in the amusement parks to rotate along the horizontal axis to rotate in one direction while carrying the number of passengers.

(ii) **Clocks**- where the hands rotate in clockwise directions only.

(iii) **Baffle gates**- in the entrances of many buildings which rotates about vertical axis in one direction.

(iv) **Shaping Machines** – in the crank and slotted arm. In the hill station, the most common problem to the drivers is to park their cars in the slope and to start up the car. While waiting in the traffic, the cars have to move on step by step very slowly, this situation is a difficult one for the drivers to make their car not to roll back in the slope. So the mechanism has to be developed to stop the vehicle from rolling back and it should not stop the vehicle in accelerating forwards. This function can be achieved by using the ratchet and pawl mechanism. The ratchet and pawl has to be designed and has to be fit in the front drive shaft in case of the front drive vehicles. The Maruti Swift Dzire car is considered and the ratchet and pawl has to be designed for it. In order to design for the worst case the road maximum slope is considered- Zoji pass Road Kashmir which has 21.80% with gradient 2/5.

Vehicle transmission hill holder Alvin H. Berger used a one-way clutch when engaged it prevents rolling of the

vehicle. A device operable in a transmission for substantially preventing vehicular rollback on an incline includes a shaft, a gear, a one-way clutch, and a pawl member. The gear is selectively connected for common rotation with the shaft. The gear is rotatable in a first rotary direction and a second rotary direction. The one-way clutch has an inner race and an outer race, where the inner race is connected to the gear and the outer race has an outer surface having a plurality of engaging teeth. The pawl member has a first end and a second end, where the first end is pivotal mounted to a transmission housing. The second end of the pawl has a first angled portion configured to release and engage at least one of the pluralities of engaging teeth of the outer race as the outer race rotates in the second rotary direction.

METHODOLOGY

In this work, locking mechanism is identified to arrest the backward motion to the car. The gear is placed in the front drive shaft and the locking lever is fitted with the frame. When the vehicle is moved in the hill road, the lever has to make the locking to touch the cylinder movement. If the vehicle tends to move backward direction, the locking cylinder is energized would stop the gear to move Counter Clockwise direction with respect to front wheel. As the vehicle is in neutral position, the locking lever is engaged the the vehicle did not move in backward direction. So the hand brakes need not to be applied. When the vehicle is in moving condition, the engagement between the gear and locking lever is detached. By activation of lever to stop power when ever needed.

RATCHETS AND RATCHETS GEARING

A ratchet is a form of gear in which the teeth are cut for one-way operation or to transmit intermittent motion. The ratchet wheel is used widely in machinery and many mechanisms. Ratchet-wheel teeth can be either on the perimeter of a disk or on the inner edge of a ring. The pawl, which engages the ratchet teeth, is a beam member pivoted at one end, the other end being shaped to fit the ratchet tooth flank.

Ratchet Gear Design. In the design of ratchet gearing, the teeth must be designed so that the pawl will remain in engagement under ratchet-wheel loading. In ratchet gear systems, the pawl will either push the ratchet wheel or the ratchet wheel will push on the pawl and/or the pawl will pull the ratchet wheel or the ratchet wheel will

pull on the pawl. See Figs. 8.1a and b for the four variations of ratchet and pawl action. In the figure, *F* indicates the origin and direction of the force and *R* indicates the reaction direction.

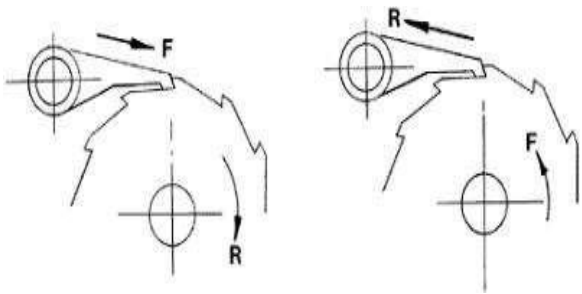

Fig. 4- Variation of ratchet and pawl action (*F* = force; *R* = reaction).

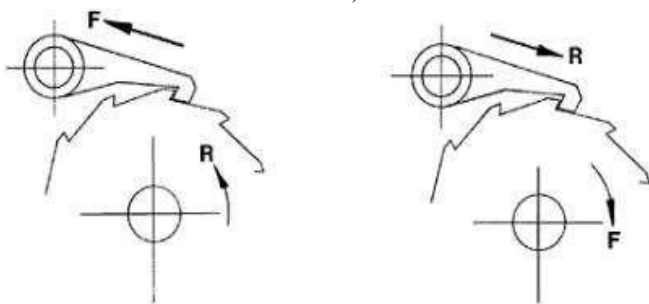

Fig. 5- Variation of ratchet and pawl action (*F* = force; *R* = reaction)

MECHANISM DESCRIPTION

The RaPR mechanism described in this work was designed with the following design criteria as constraints: the ratchet wheel should advance one and only one tooth per actuation pulse; the ratchet wheel driver and restraint mechanism will be in a planar arrangement; the ratchet mechanism should operate on as little space of the ratchet wheel as possible; stand-alone spring elements and complicated assemblies should be minimized or eliminated; moving parts should be balanced about their pivot points; the aspect ratio of parts will be 10:1 or less; the device must be able to be actuated by a stator electromagnet; the driver mechanism will act as the rotor to the electromagnet stator by completing a magnetic circuit; the ratchet wheel will have 36 teeth; no lubricants will be considered for friction reduction; the ratchet mechanism will be

designed such that it can be fabricated using micro wire EDM.

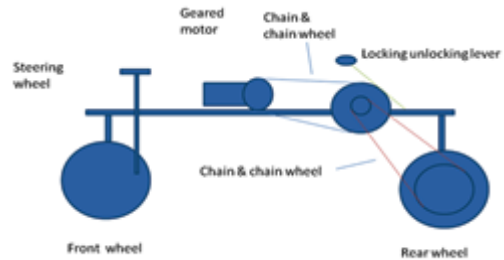

Fig.6- Ratchets And Ratchets Gearing

PRINCIPLE

The power drive shaft is connected to locking mechanism which drives the rear wheel connection . whenever the shaft is rotated in forward direction the locking is open by control switch. As when ever on the stop road climbing the vehicle try roll in down ward direction . that is reverse direction in this circumstance the cylinder locks the geart resulting the motion to stop in reverse direction ,hence the roll of the vehicle is comes to rest . the entire load is locked on the lock lever which should have capacity to hold. As soon as the power from drive shaft is delivered to the vehicle the ratchet starts to move in forward direction resulting releasing of lever . the released pawl will allow the vehicle to move in forward direction.

Both are in such a way that they get mated as soon as possible even in their rotation. So when the lever is actuated then one of the plates is pushed to the other so that the plates get mated and hence the shafts are connected. So thus the differential is disengaged. To engage the differential again a spring is used to push the plates apart. Thus this is the working principle of this project.

WORKING

In this work, Ratchet and Pawl mechanism is identified to arrest the backward motion to the car. The ratchet is placed in the front drive shaft and the Pawl is fitted with the frame. When the vehicle is moved in the hill road, the lever has to make the pawl to touch the ratchet. If the vehicle tends to move backward direction, the pawl would stop the ratchet to move Counter Clockwise direction with respect to front wheel. As the vehicle is in

National Conference on Current Trends in Engineering, Science and Technology (NACCTEST- 2018)
Organized by GF's Godavari College of Engineering, Jalgaon
International Journal of Innovations in Engineering and Science, Special Conference Issue, 2018
www.ijies.net

neutral position, the pawl engaged the ratchet and the vehicle did not move in backward direction. So the hand brakes need not to be applied. When the vehicle is in moving condition, the engagement between the ratchet and pawl is detached with the help of lever arrangement.

The fabricated mechanism is fitted in drive shaft for testing experimentally to check whether the functionality has been achieved (Figure 5). The hand driven lever is turned in forward direction, similar to forward motion of the car, the pawl does not

stop the ratchet to rotate. The hand lever is turned in opposite direction similar to the reverse motion of the car in the hill road, and the pawl stops the rotation of the ratchet. So the drive shaft and the wheels did not rotate. Therefore the reverse motion of the wheels is arrested. The same can be achieved if this model is fitted in the car. This will be the case while fitting this mechanism in the drive shaft of the car. When it has been done the car cannot move in reverse direction in the slope as the pawl locks the ratchet.

ADVANTAGES

- [1] It requires simple maintenance cares
- [2] The safety system for automobile.
- [3] Checking and cleaning are easy, because of the main parts are screwed.
- [4] Easy to Handle.
- [5] No Manual power required is less
- [6] Repairing is easy.
- [7] Replacement of parts is easy.
- [8] No Oil wastage.

DISADVANTAGES

- Initial cost is high.
- High maintenance cost

APPLICATION:

- It is very much useful for Car Owners & heavy trucks.
- This lock braking system is used for smooth anti roll of vehicle of the vehicles.
- Thus it can be useful for the following types of vehicles;

CONCLUSION

The Hill Descend Control System for vehicle features its help has proven to be beneficial to manual transmission drives that find themselves one grade that would normally make driving difficult. In addition to manual to transmission vehicle, the driving experience of vehicle with automatic transmission enhanced. The choice of which method of hill descend control system to implement is influenced by many factors desired performance system cost and vehicle powertrain. When implemented correctly the functionality of the hill descend controlled system features seamlessly matches the drivers normal driving habits and instincts. Hill descend controlled system function makes the driving experienced as comfortable and natural as possible while keeping the system commercially feasible. By using this features we can drive vehicle easily.

REFERENCES

- [1] A. Arunkumar, T. Muthumani, V. Subramani, "Design and Fabrication of antiroll back system in vehicle using ratchet and pawl mechanism". *International Journals of emerging technology in computer science and electronics (IJETCSE)* pp2015 Volume12, ISSN 0976-1353,
- [2] Mohamad tamimi, Deron littlejon, Mark Kopka and Gordan Seeley, Hill hold molding pp 2005 SAE international Volume 3, ISSN 2005-05-0786
- [3] Jiang xuefeng, Xu Xian, Guodong, Chaen Wei, "Research on Hill Start control", the 2nd international conference on computer application and system modeling pp2012, ISSN 1812-5654
- [4] Cook George, "anticrip and hill holder break system" (US2938611A), international conference california pp1960, volume12, ISSN 571-656.
- [5] Zang l, Li h, "hilling startup controlled method using accelerometer". *Vehicular electronics and safety, IEEE international conference*, pp2006, volume 9 ISSN 1457-4689.

National Conference on Current Trends in Engineering, Science and Technology (NACCTEST- 2018)
Organized by GF's Godavari College of Engineering, Jalgaon
International Journal of Innovations in Engineering and Science, Special Conference Issue, 2018
www.ijies.net

Study on Optimization of Operating Performance of Bicycle, Tricycle and other Similar Vehicles

Pravin Dharmaraj Patil¹, Mahesh Ashok Marathe², Anand O. Dubey³, Abhishek P. Shukla⁴

^{1,2}Assistant Professor of Mechanical Engineering, SSBT's COET, Bambhori, Jalgaon, (M. S.), India, 425001

^{3,4} Students of Mechanical Engineering, SSBT's COET, Bambhori, Jalgaon, (M. S.), India, 425001

¹Email:- pravinpatil100@rediffmail.com

Abstract – The tricycle rickshaw or the bicycle is used for transportation in local areas. These vehicles are human-powered and pedal-driven. The tricycle rickshaw is often used for commercial purposes. The bicycles and tricycles which are available nowadays are having much deficiencies. This bicycles and tricycles are less efficient or you can say having less mechanical advantages. The purpose of this paper is to review the patents (which are able access) and experimental work of the researchers on the drive mechanism of bicycles and tricycles for optimizing the operating performance.

Keywords- Chain drive mechanism, Sprocket, Velocity ratio.

INTRODUCTION

On small scale local means, bicycles and tricycles are widely used for transportation. The tricycle rickshaw is used hire passengers. In South Asia, Southeast Asia, the tricycle rickshaw is used as crucial option for employment by the people who migrate from rural areas, generally the poor men. Many locally arrayed cycles are used all over the world. Places where there is ban on use of motor vehicles, human-powered cycles are one of the main mode of transportation.

But still the cycles available in the local market are having much deficiencies. This bicycles and the tricycles have less efficiency or mechanical advantage. Researches and experimental work are carried out on increasing the efficiencies of the chain drive mechanism of this vehicles.

A. Mechanical Advantage

In physics and engineering, mechanical advantage (M.A) is the factor by which a machine multiplies the force put into it with the help a mechanical device , tool or arrangement of tools. For the cycles, the multiplication

of forces on pedal and the rotating wheel is done to increase the mechanical advantage. It is possible to measure the mechanical advantage either by travelling a certain distance without varying the magnitude of force applied (pedal) or by travelling the same distance by applying less force on cycle (pedal).

B. Drive Ratio

Generally,
Mechanical advantage, M.A. = V.R = RPM of driving machine / RPM of driven machine.

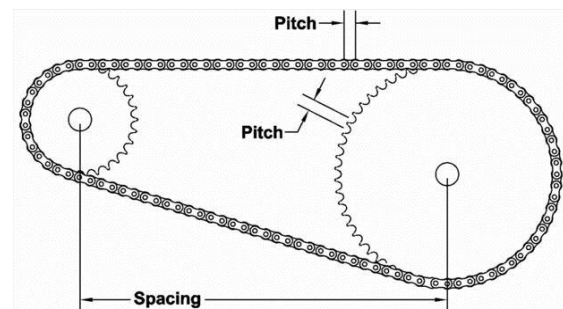

Fig. 1- fig shows the Chain drive mechanism in cycles
But in case of cycles,

M.A. = No. of rotation of driving sprocket wheel /
No. of rotation of driven sprocket wheel.

Where,

M.A. = Mechanical advantage.

V.R. = Velocity ratio.

Therefore, if the velocity ratio is increased, M.A. is increased i.e. increment in efficiency too.

LITERATURE SURVEY

Kenneth S. Keyes have performed a patented work or invention related to drive shaft driven bicycle. The object of his invention was to provide a bicycle having a

National Conference on Current Trends in Engineering, Science and Technology (NACCTEST- 2018)
Organized by GF's Godavari College of Engineering, Jalgaon
International Journal of Innovations in Engineering and Science, Special Conference Issue, 2018
www.ijies.net

means of linear transmission from the pedal to hub of the bicycle for better efficiency & speed ratios than prior bicycle. A number of problem may be associated with traditional coaster or 3-speed bicycle chains. They are subjected to slippage if the length of the chain is not correctly adjusted. To overcome above problem, Keyes designed a bicycle which had a driver bevel gear connected to the pedals, a driven bevel gear at the hub of the rear wheel, one or more drive shafts having beveled gears at each end & capable of transmitting the rotation of the driver gear to the driven gear [1]. Another experimental study to determine the effects of cycle crank length on maximum cycling power, optimal pedaling rate, and optimal pedal speed, and to determine the optimal crank length to leg length ratio for maximal power production. The experiment has been performed using crank lengths of 120, 145, 170, 195, and 220 mm [2]. An individual idea or any possible combination of different ideas can be used, in order to optimize operating performance of driving mechanism for cycle. The velocity ratio of mechanism, torque generated at drive side, pedal crank length, chain drive efficiency, chainring shape are some important parameters used to optimize performance of drive mechanism of cycle. Also the efficiency of the bicycle chain drive depends on the chain operation as it engages and departs from the sprockets on the high-tension part of the drive [3]. Rastogi implemented a FEA approach to design and analyze a composite drive shaft in different conditions [4]. Improved bicycle infrastructure is positively and significantly correlated with higher rates of commuting by bicycle that could include promotion of folding bicycle. Most people understand the general concept of a folding bicycle but do not recognize the overall value of improved product design given that few people are willing to pay for additional costs [5].

RELATED ACTIVITIES

A. Design and fabrication of Shaft Driven Bicycle

A bicycle that uses shaft drive mechanism instead of chain drive mechanism is known as a shaft driven bicycle. Kenneth S. Keyes performed a patented work and invented drive shaft driven bicycle. The work was aimed to make human effort less while riding bicycle. In this work optimization of the cycle is done by converting the rotary motion of the sprockets into linear motion using two bevel gears. Due to recent

advancement in internal gear technology, researchers use the bevel gears for higher efficiencies of the cycle.



Fig. 2- fig shows the bicycle with changed mechanism

Instead of using chain drive mechanism, one piece drive shaft is used for rear wheel drive bicycle which are optimally designed and manufactured for the ease of power transmission. The result obtained from this experiment is very much useful for the earlier development in saving time and power. Hence, by applying the bevel gears and shaft attachment instead of chain and sprocket, the transmission is easy and smooth.

B. Variable gear ratio chain drive system for bicycle

A patented work in which researcher has changed diameter of drive sprocket to improve the drive mechanism efficiency of cycle. As mentioned earlier, the efficiency or mechanical advantages of the drive mechanism can be increased with the increase in velocity ratio.

From above,

$$M.A. = V.R.$$

= No. of rotation of driving sprocket wheel / No. of rotation of driven sprocket wheel.

= Diameter of driving sprocket / Diameter of driven sprocket.

National Conference on Current Trends in Engineering, Science and Technology (NACCTEST- 2018)
 Organized by GF's Godavari College of Engineering, Jalgaon
International Journal of Innovations in Engineering and Science, Special Conference Issue, 2018
 www.ijies.net

U.S. Patent Dec. 12, 1978 Sheet 1 of 2 4,129,044

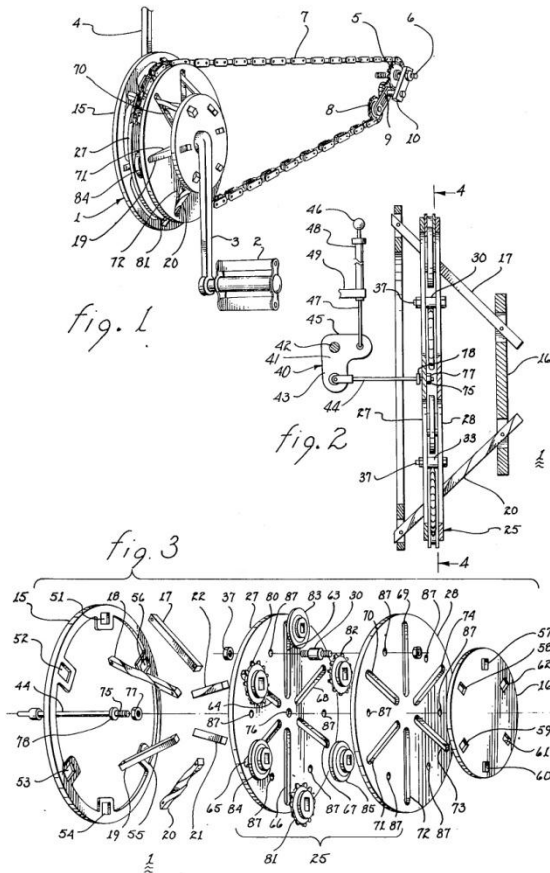

Fig. 3- fig shows the Variable gear ratios chain drive system.

Therefore, when the diameter of drive sprocket is increased, we get higher velocity ratio and also the increment in the drive mechanism efficiency or the mechanical advantage.

C. Chain drive and automatic chain tensioning unit

A patent work was performed by Lawrence R. Gardener on chain drive mechanism and he invented the automatic chain tensioning unit.

U.S. Patent Mar. 4, 1980 Sheet 1 of 2 4,191,062

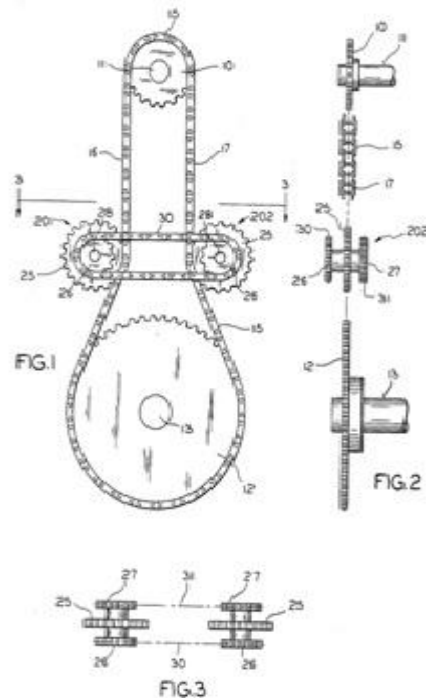

Fig. 4- fig shows the Chain drive & Automatic chain tensioner unit.

In his work, he claims an automatic drive chain tensioner which includes one pair of idler assembly with each idler assembly consisting of an idler sprocket and indexing sprocket on both the side of and concentrically fitted to the idler sprocket with each idler assembly which is being adapted to be placed on the outside of a drive chain loop on a chain which runs between a drive and driven sprocket with the idler sprocket of that adapted to be engaged in the drive and the idler assemblies on the other drive which is apart and runs the chain and a pair of indexing chain loops, in which each one is adapted to engage an indexing sprocket on each of the spaced apart assemblies.

D. Effects of frictional loss on bicycle chain drive efficiency

This experiment was performed by James B. Spicer on the efficiency of bicycle chain drives in many types of operating conditions and to inquire about the factors that affect the chain drive efficiency. Investigation of

National Conference on Current Trends in Engineering, Science and Technology (NACCTEST- 2018)
 Organized by GF's Godavari College of Engineering, Jalgaon
International Journal of Innovations in Engineering and Science, Special Conference Issue, 2018
 www.ijies.net

the efficiencies was carried out in both the ways; experimentally as well as theoretically. To interpret the experimental results, these models were used for drive losses. On the basis of a assumption that the losses which result in the chain drive is from friction between contacting components that execute motion with respect to one another, there are three sources for the loss as follows:

- [1] Friction between inner link bushing and chain pin.
- [2] Friction in the chain line offset.
- [3] Friction between sprocket tooth, link roller and inner link bushing.

For the derailleur-type chain drive, the tests of efficiencies indicate that the overall efficiencies to transmit power from the front drive sprocket to back drive sprocket ranges from 80.9 percentage to 98.6 percentage. The primary factors that affect the efficiency of the cycle are the sizes of sprockets in the drive and the tension in the chain. In the experiment, it was concluded that the larger sprockets more efficient power transfer than the smaller sprockets. In the models which were used for interpreting the friction losses, 2 to 5% loss difference was measured between 52 to 11 and 52 to 21 sprocket combinations. Experimental results showed that highest efficiencies occurred at high chain tensions and lowest efficiencies occurred at low chain tensions. Under laboratory conditions, the chain line offset and chain lubrication had negligible effect on the efficiency. From the result it appears that, the bicycle's chain drive efficiency depends intimately on the chain operation. In the chain operation, the chain engages and departs on the high tension part of the drive from the sprockets. Observing the high efficiencies measured under high chain tensions, it is concluded that frictional losses are only few percent of the overall losses.

E. Determinants of maximal cycling power: crank length, pedalling rate and pedal speed

J.C. Martin investigated to determine the effects of cycle crank length on maximum cycling power, optimal pedaling rate and optimal pedal speed and to determine the optimal crank length to leg length ratio for maximal power production. In the experiment cranks of length 120, 145, 170, 195 and 220mm were used.

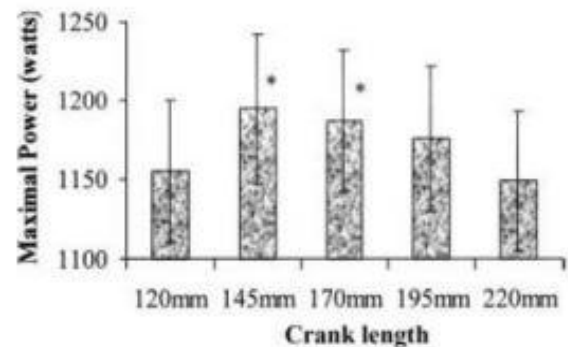

Fig. 5- fig shows the Maximum power v/s cranks length.

The results of the experiment are shown in graphical just above. The figure shows graph between maximum power and cranks length. Maximum power varies by 4% across the range of crank lengths tested. The cycle crank lengths that varied by 83% elicited a little bit of 4% difference in maximum cycling power. We can clearly see from figure 6 that, the optimal pedaling rate decreases significantly as there is increase in the crank length, from 136 rpm for the 120mm cranks to 110 rpm for the 220mm cranks.

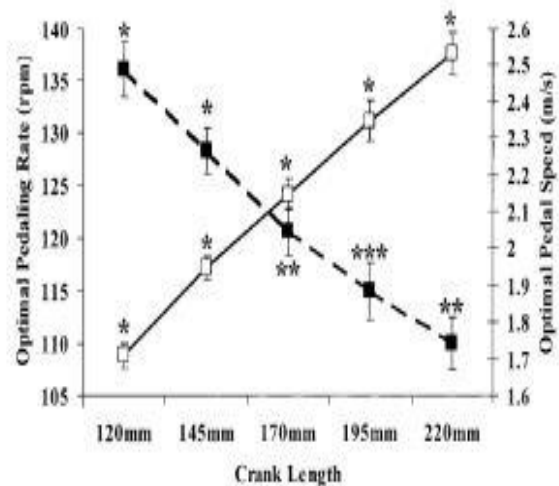

Fig. 6- Fig shows the Optimal pedalling rate & optimal pedal speed.

Where,

(■): Optimal pedaling rate.

(*): differs from all other crank lengths.

(**): differs from all lengths except 195 mm. (***) differs from the 120- and 145-mm crank lengths.

National Conference on Current Trends in Engineering, Science and Technology (NACCTEST- 2018)
Organized by GF's Godavari College of Engineering, Jalgaon
International Journal of Innovations in Engineering and Science, Special Conference Issue, 2018
www.ijies.net

□ Optimal pedal speed

Conversely, optimal pedal speed increases significantly with the increase in crank length, from 1.71 m/s for the 120 mm cranks to 2.53 m/s for the 220 mm cranks.

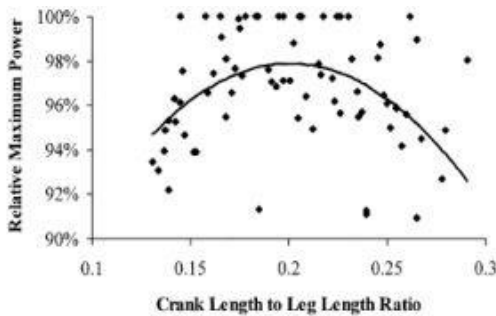

Fig. 7- fig shows the Relative maximum power v/s Crank length to leg length ratio.

From the figure 7, the crank length to leg length to tibia length ratios are 20.5 percent and 21.1 percent of the variability in maximum power, respectively. The optimal crank length was 20 percent of leg length or 41 percent of tibia length. According to this data, the pedal speed and pedalling rate exert distinct effects that influence muscular power during cycling.

CONCLUSION

The aim of the presented work was to study of drive mechanisms of bicycle, tricycle and other similar vehicles to optimize operating performance. Changes in the drive mechanism have replaced the traditional methods. In some cases, chain drive mechanism is replaced by new mechanisms. The velocity ratio of mechanism, pedal crank length, torque generated at drive side, chain drive efficiency are some of the important aspects of optimizing the performance of drive mechanism of cycles. The efficiency of the bicycle intimately depends on the chain operation of engaging and departing from the sprockets.

REFERENCES

[1] J.C. Martin, W.W. Spirduso "Determinants of Maximal Cycling power: Crank length, Pedaling rate and Pedal speed", Springer-Verlag, 84, 2001, 413-418.
[2] Rahul U. Urunkar, Prof. P.P. Deshpande "Study of Drive Mechanisms of Bicycle, Tricycle or Like Vehicles to Optimize Operating Performance - A Review", Int. Journal of Engineering

Research and Applications ISSN : 2248-9622, Vol. 4, Issue 1(Version 2), January 2014, pp.214-219.

- [3] Rastogi, N. (2004) "Design of composite drive shafts for automotive applications", Visteon Corporation, SAE technical paper series.
[4] A.K. Singh, A.S. Bobade, A.K. Ghodmare, B.C. Bisen, H.H. Walmik, P.C. Padole, V.U. Gaikwad, C.K. Tembhurkar, N.K. Mandavgade "Concept of User Friendly Modified Folding Bicycle", European Journal of Applied Engineering and Scientific Research 2014, 3 (1):16-20.
[5] R.S. Khurmi, J.K. Gupta "A Text Book of Machine Design", S CHAND, 2005.
[6] B.D. Shiwalkar "Design Data for Machine Elements", Denett, 2013.
[7] James B. Spicer, Christopher J. K. Richardson, Michael J. Ehrlich, Johanna R. Bernstein, Masahiko Fukuda, Masao Terada, Effects of Frictional Loss on Bicycle Chain Drive Efficiency, ASME, 123,2001, 598-605.
[8] J.C. Martin, W.W. Spirduso, Determinants of maximal cycling power: crank length, pedaling rate and pedal speed, Springer-Verlag, 84, 2001, 413-418.
[9] Paola Zamparo, Alberto E. Minetti, Pietro E. di Prampero, Mechanical efficiency of cycling with a new developed pedal-crank, Elsevier-Journal of Biomechanics, 35, 2002, 1387-1398.
[10] Jeffery W. Rankin, Richard R. Neptune, A theoretical analysis of an optimal chaining shape to maximize crank power during is kinetic pedaling, Elsevier-Journal of Biomechanics, 41, 2008, 1494-1502.
[11] Dr. Iqbal Husain, (2012) "Electric and hybrid Vehicles: Design Fundamentals", CRC press, Taylor and Francis Group, USA.
[12] Patrick E. Turner; Lawrence K. O'Dell. "BICYCLE WITH SELECIBLY ENGAGEABLE SINGLE OR DUAL WHEEL DRIVE". United States Patent. Turner et 81. Patent Number: 5,332,244 Date of Patent: Jul. 26, 1994
[13] CHETAN A. SAMARTH, A. K. MAHALLE "DESIGN OPTIMIZATION OF SPEED RATIO FOR CONVENTIONAL CHAIN DRIVE USED IN TRICYCLE" International Journal of Innovative Technology and Exploring Engineering (IJITEE) ISSN: 2278-3075, Volume-1, Issue-1, June 2012
[14] Ben Jose, Aswin B Vasanth, Adityan R, Basil George Thomas "TWO WHEEL DRIVE MOTORCYCLE" IOSR Journal of Mechanical and Civil Engineering (IOSR-JMCE) e-ISSN: 2278-1684, p-ISSN: 2320-334X, Volume 11, Issue 1 Ver. 1 (Jan. 2014), PP 25-32 www.iosrjournals.org
[15] Rahul U. Urunkar, Prof. P. P. Deshpande "STUDY OF DRIVE MECHANISMS OF BICYCLE, TRICYCLE OR LIKE VEHICLES TO OPTIMIZE OPERATING PERFORMANCE - A REVIEW" Int. Journal of Engineering Research and Applications www.ijera.com ISSN : 2248-9622, Vol. 4, Issue 1(Version 2), January 2014, pp.214-219
[16] Glenn F. Read "POWER DRIVE" United States Patent Patent Number: 4,397,369 Date of Patent: Aug. 9, 1983.

National Conference on Current Trends in Engineering, Science and Technology (NACCTEST- 2018)
 Organized by GF's Godavari College of Engineering, Jalgaon
International Journal of Innovations in Engineering and Science, Special Conference Issue, 2018
 www.ijies.net

Experimental Investigation of Human Operated Water Pumping With Electricity Generation

Pravin Dharmaraj Patil¹, Mahesh Ashok Marathe², Dipak V. Chaudhari³, Nikhil Bari⁴

^{1,2}Assistant Professor of Mechanical Engineering, SSBT's COET, Bambhori, Jalgaon, (M. S.), India, 425001

^{3,4}Students of Mechanical Engineering, SSBT's COET, Bambhori, Jalgaon, (M. S.), India, 425001

¹Email:- pravinpatil100@rediffmail.com

Abstract— Bicycle is the most cheap and easiest mode of transport especially in countries like India on which humans apply their effort to propel the bicycle, over centuries from now. Human effort is transferred to the wheels through pedals, crank and chain mechanism. But the same pedal power can be used for other purposes such as to generate electricity, to operate hand tools or agricultural tools. Therefore, an idea of using pedal power is presented in this paper. In this paper, a system is fabricated for generating electricity by pedaling a bicycle and at the same time water pumping also. The fabricated mechanism is tested to determine its performance and results are presented.

Power Generation Using human effort is a force for the future. With increasing demand for fuel and a new source of energy, development of human powered generators become a necessity. The most famous human powered generator is dynamo. On similar lines various human powered generators like backpack generators, biomechanical energy harvester and shoe generator are being developed. Human power is an endless source of energy which has been wasted. The energy is stored in a mechanical form and retransmitted to the wheel in order to help the acceleration. Electric vehicles and hybrid have a similar system called Regenerative Brake which restores the energy in the batteries. The device recovers the kinetic energy that is present in the waste heat created by the car's braking process. It stores that energy and converts it into power that can be called upon to boost acceleration. There are principally two types of system - battery (electrical) and flywheel

(mechanical). Electrical systems use a motor-generator incorporated in the car's transmission which converts mechanical energy into electrical energy and vice versa.

Keywords- Bicycle, Electricity, Pedal Power, Water Pumping.

INTRODUCTION

The idea of pumping water has been in existence since the evolution of man. Pumping plays a very pivotal role in the day to day existence of mankind and as a result, different methods have evolved over the years to pump or displace water. Water supply has been a very critical issue, mostly affecting the rural areas. Different methods and techniques have been used over the years ranging from man-powered operated ones down to the more efficient, but costly electrically and internal combustion engine powered pumps. The mechanism consists of single centrifugal pump which is fixed with the rear wheel bicycle. The pulley arrangement converts the efforts which are applied by human being into the rotating motion which is used to generate electricity and this electricity will be used as a preliminary requirement of electricity.

National Conference on Current Trends in Engineering, Science and Technology (NACCTEST- 2018)
 Organized by GF's Godavari College of Engineering, Jalgaon
International Journal of Innovations in Engineering and Science, Special Conference Issue, 2018
 www.ijies.net



Fig. 1- fig shows the Pedal powered machines

In a world with growing demand for energy, it has become a necessity for alternate source of energy. As a result various inventions have been made to overcome the issue. Increasing efficiency of electrical and mechanical products has been one of the ways to reduce energy consumption. These techniques are useful for reducing energy consumption. One such way is to develop alternate source of energy which will help us to save energy. Geothermal energy, biogas, solar energy, wind energy are various forms of energy which are used alternatively today. One such source of energy is Human Power. Human power is an endless source of energy which has been wasted. Humans eat food and spend it on his work without proper conversion of energy. This paper brings to light various benefits of human power also the harvesters used to utilize this power. Various harvesters which use human power to generate electricity or power include cycle Dynamo, Biomechanical Harvesters, shoe Generator, Backpack generator. These devices utilize human energy to produce mechanical work.

LITERATURE SURVEY

Atul. P. Ganorkar et al. [1] conducted an experiment on "Development of pedal operated water pump". Their machine consists of three subsystems namely (1) Energy Unit : Comprising of a suitable peddling mechanism, speed rise gear pair and Flywheel conceptualized as Human Powered Flywheel Motor (HPFM) (2) Suitable

torsionally flexible clutch and torque amplification gear pair and (3) a water pump

unit. Vishal Garg et al. [2] conducted an experiment on "Pedal powered water pump". They founded an pedal operated pump can be construct using local material and skill. This bicycle pedal operated pumps water at 2-3 gallons per minute from wells and boreholes up to 23 in feet depth. Provides irrigation and drinking water where electricity is not available. Ademola Samuel Akinwonmi et al. [3] conducted an experiment on "Pedal powered centrifugal pump for pure water supply device". This analyzes the design of a pedal powered purified water supply device to be used by local dwellers. It works on the principle of compression and sudden release of a tube by creating negative pressure in the tube and this vacuum created draws water from the sump into the pump while rollers push the water through to the filter where adsorption takes place to purify the water. Bryan Lee[4] has prepared a conceptually "Simple water pump" that will be easy to maintain and repair using basic tools while providing enough water flow to irrigate a small plot of farmland. The report outlines the design process that has been followed and a description of the agreed model that is to be constructed, cost analysis and timeline. M.Serazul Islam et al. [5] conducted an experiment on "Design and development of pedal pump for low lift irrigation". A study was undertaken to design and construct a low-lift pedal pump for use in small irrigation project areas. For this purpose, different types of piston valves and check valves were constructed and tested at different suction heads in the laboratory to evaluate their performances. During pedal pump operation, less input power was needed and it can be operated by one adult man for a long time (more than 2 hours) continuously without being tired. Efficiency of the pump was 46.53 percent against a head of 1.65 m. In the July-2011 issue of IEEE Spectrum, a detailed study and analysis of pedal power energy generation, its usage, feasibility, and economics is presented. The power is produced from the exercise bikes used in gyms by means of a small generator. This article presents a case where in it looks at the overall feasibility of including the pedal power technology in the mainstream. Besides all these studies available in the literature, many other applications can be developed using pedal power such as generators, washing machines, farm and factory applications, blenders and many other applications. One such attempt is made in this work to use pedal power as

National Conference on Current Trends in Engineering, Science and Technology (NACCTEST- 2018)
Organized by GF's Godavari College of Engineering, Jalgaon
International Journal of Innovations in Engineering and Science, Special Conference Issue, 2018
www.ijies.net

a source for generating electricity and also for water pumping. Performance analysis of fabricated unit is carried out Onwards of 1876, it is attached to tools like lathes, saws, grinders, shapers, tool sharpeners and to boring, drilling and cutting machines [2]. The air-craft is also flown for sufficient distance on human powered systems [3]. In 20th century, the human powered systems are widely used in Pedal-powered transmitter, Windup radio, Military radio [1] DAVID SOVERWINES's village-scale human power plants [4]. Center of bicycle technology runned by Maya pedal a Guatemalan NGO based in San Andrés Itzapa, successfully tested for a range of heights.

A. First Model for electricity

The first prototype was developed using a car alternator. A used 40 Amp car alternator was used. The speed needed to get an output of 6 amps was over 90 rpm (at pedals). It was felt after use for about a month that this speed was pretty high and could not be maintained. A reclining chair was used for sitting. Therefore other design changes were considered. Limitations were found to be the design of generator and lighting system.

B. Second Model for electricity

The second prototype was developed using a reclining chair but a low rpm DC motor that was originally developed for an electric bicycle. A 15-ampere diode was connected so that the battery would not drive the motor when the pedaling stopped. Pedalling speed required to achieve 6 amps output was brought down to 70 rpm. The frame was made of mild steel angles and square channels. A 40 Amp-hour battery was used to store the electricity. Two 11-watt compact fluorescent lamps were used for lighting. This model was installed in the Narmada valley and used for a year and feedback obtained. The photo on the right shows the second prototype.

C. Third Model for electricity

A Third model was made to include all the feedback received for the second prototype. The seat was changed to a standard bicycle seat and basic frame of a bicycle was used to manufacture the machine. An LED bar indicator and an ampere metre were added for state of battery and rate of charging indicator respectively. The ratios were changed so that pedalling speed was brought down to 40-60 rpm. Various experiments were done with varying sizes of flywheels and finally a flywheel was

attached on the generator to balance the irregulariof pedalling force.

METHODOLOGY

STEP 1: Collection of the Raw material.

STEP 2: Assemble the parts.

STEP 3: Power given to cycle rim by Paddling [5].

STEP 4: Rim is connected to the alternator by rotating shaft.

STEP 5: These output is used for alternator to generate electricity.

MATERIAL COMPONENTS

- A. Bicycle with stand.
- B. Bicycle Rim.
- C. Dynamo : 12 VOLT DC Motor which is Obtaining 3-12 Volt Supply. An Dynamo is an Electrical Generator, that converts mechanical energy to electrical energy in the form of Direct current.
- D. Pulley.
- E. Shaft.
- F. Fan.
- G. Storage Batteries.
- H. Bulb Connections.
- I. Mobile Charging Setup.
- J. Piping systems.
- K. Centrifugal pump.
- L. B-70 size belt.

I. THE BASIC PRINCIPLE

- A. By Giving rotating Motion To the shaft through the pedal. We implementing the Faraday's Law due to which electricity generation takes place.
- B. These altering source of energy can be stored or simultaneously can be used.

II. SCHEMATIC DIAGRAM

National Conference on Current Trends in Engineering, Science and Technology (NACCTEST- 2018)
 Organized by GF's Godavari College of Engineering, Jalgaon
International Journal of Innovations in Engineering and Science, Special Conference Issue, 2018
 www.ijies.net

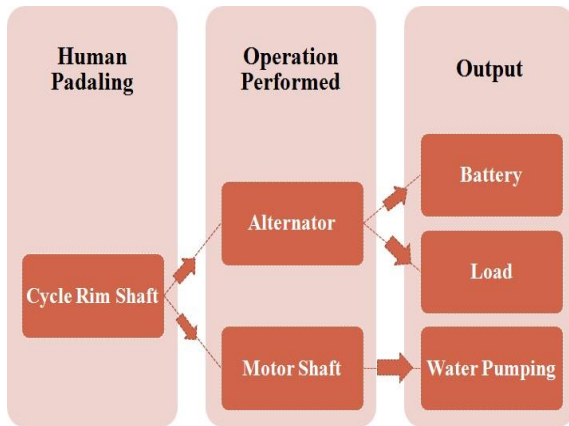

Fig. 2- Flow chart

RESULTS FOR ELECTRICITY

The Dynamo output is also calculated at different weights of the person's by varying speed of the bicycle. The performance of the Dynamo is tested using a person weight of 60kg's as indicated in the Table,

Table 1- Electricity Generation Results

Bicycle speed (RPM)	Output Volt (V)	Output Current (A)
104	7	0.236
141	7	0.369
190	9	0.615

RESULTS FOR PUMPING

Table 2- Water Pumping Results

Speed of the Wheel RPM	Speed of Impeller Shaft RPM	Discharge(m ³ /sec)
78	900	0.192
102	1060	0.222
117	1364	0.374
141	1574	0.590

In domestic purpose the discharge may vary due to the individual person's weight and ability (strength). Thus when compared with trained person having greater ability (strength) to pump the water quickly and charge the battery, in turn depends upon the speed of the cycling. Above results are obtained.

III. GRAPHICAL REPRESENTATION

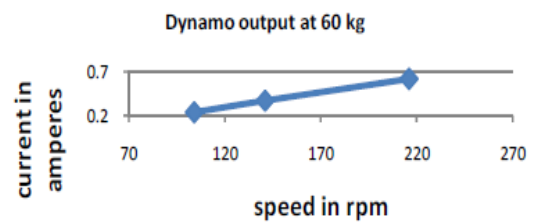
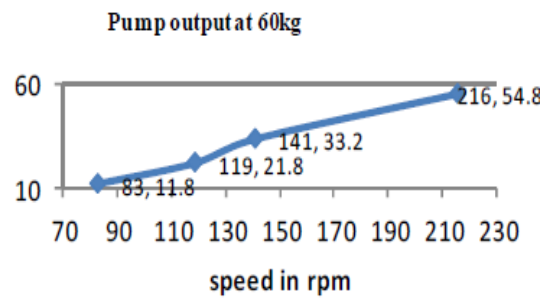

APPLICATIONS

- A. Water Pumping:
 - a. Provide drinking water and irrigation in remote areas where electricity is not available.
 - b. It is portable one which can be used for irrigation at various places and at various heights in the same building.
- B. Electricity Generation:
 - a. Electricity generated can be stored in the battery and may be used for different applications- mobile charger, Lamps, etc.
 - b. Most of the electric based work can be done on this even if power is cut off.

ADVANTAGES

- a. This system is helpful for rural areas.
- b. Electricity generation is help full to us for many purposes like Bulb, fan and some other appliances are used over the batteries.
- c. This system is easy to maintain and make.
- d. In this system, Power generation is simple by pedaling on this arrangement.
- e. This system is Time and effort required is medium.
- f. This system is Low Cost.
- g. This system is both gardening & Cycling Can Do Simultaneously.

National Conference on Current Trends in Engineering, Science and Technology (NACCTEST- 2018)
Organized by GF's Godavari College of Engineering, Jalgaon
International Journal of Innovations in Engineering and Science, Special Conference Issue, 2018
www.ijies.net

- h. In this system is electricity generation is Helpful To Us For Many Purposes.

CONCLUSION

The whole study over the topic that the wheel deal bicycle powered electricity generation is a very advantageous especially for rural areas. The problem of energy crises is very big in India and by use of this project. We generate electricity and the stored energy can be used for small and medium level application. This project is installed any of the place where water is Available.

REFERENCES

- [1] Atul.P.Ganorkar K.S.Zakiuddin, H.A.Hussain, "An Experiment on Development of Pedal Operated Water Pump", IOSR, e-ISSN 2278-1684, (2014).
- [2] Vishal Garg, Neelesh Khandare, Gautam Yadav, "An Experimental Setup and Design of Pedal Powered Water Pump", International Journal of Engineering Research and Technology (Vol.2, Issue.1) (2013).
- [3] Ademola Samuel Akinwonmi, Stephen Kwasi Adzimah, Fredrick Oppong, "An Experiment on Pedal Powered Centrifugal Pump for Purified Water Supply Device" ISDE (Vol.3, No.11) (2012).
- [4] Bryan Lee, "A Design of Simple Human Powered Water Pump", International Journal of Technology (2007).
- [5] Bryan Lee, "A Design of Simple Human Powered Water Pump", International Journal of Technology (2007).
- [6] The article from Kris De Decker (edited by Shameez Joubert) Pub. by Low Tech Magazine "World's First Aerial Bicycle Flies" Popular Science: 41. October 1923. ISSN 0161-7370.
- [7] "The Human-Powered Home: Choosing Muscles Over Motors", Tamara Dean, New Society Publishers, 2008.
- [8] Proc. of the Intl. Conf. on Future Trends in Structural, Civil, Environmental and Mechanical Engineering □ FTSCEM 2013, ISBN: 978-981-07-7021-1 doi:10.3850/978-981-07-7021-1_47 pg no.31.
- [9] M. P. Mohurle, Dr. D.S. Deshmukh, P. D. Patil "A Review on Human Power Utilization for Direct and Electricity Generation" PRATIBHA: INTERNATIONAL JOURNAL OF SCIENCE, SPIRITUALITY, BUSINESS AND TECHNOLOGY (IJSSBT), Vol. 4, No. 1, Nov. 2015.
- [10] Dr.D.S.Deshmukh, P.D.Patil, "Review on Human Power Utilization for Direct and Electric Generation," PRATIBHA: International Journal of Science, Spirituality, Business and Technology (IJSSBT), Vol. 4, No. 1, Nov 2015, ISSN (Print) 2277-7261.
- [11] Mayur Mohurle, Dr. D. S. Deshmukh, P. D. Patil, "Human Power Using Bicycle Mechanism as an Alternative Energy Source: A critical Review ", Global Trends in Engineering, Technology and Management (ICGTEM 2016), 4-6 Jan, 2016, ISSN: 2231-5381.
- [12] M.P. Mohurle, Dr. D.S. Deshmukh, Prof. P.D. Patil, " A Review On Ergonomic Considerations In Development Of Human Powered Electric Generation System", International Journal Of Science, Spirituality, Business And Technology (IJSSBT) VOL.4, No.2 ISSN(Print) 2277-7261.
- [13] M.P. Mohurle, Dr. D.S. Deshmukh, Prof. P.D. Patil, " Human Powered Electric Generation machine", preceding to publish in journal PRATIBHA: INTERNATIONAL JOURNAL OF SCIENCE, SPIRITUALITY, BUSINESS AND TECHNOLOGY (IJSSBT), Vol. 4, No. 1, Nov. 2015, ISSN (Print) 2277—726.
- [14] M.P. Mohurle, Dr. D.S. Deshmukh, Prof. P.D. Patil, " A Review on Ergonomic Considerations in Development of Human Powered Electric Generation System" , PRATIBHA: INTERNATIONAL JOURNAL OF SCIENCE, SPIRITUALITY, BUSINESS AND TECHNOLOGY (IJSSBT), Vol. 4, No. 2, May 2016 ISSN (Print) 2277—726160.
- [15] K. Bansal Laxmi Publication (P) Ltd. □ Reference book.
- [16] Machine Design (S. I. Units) By R.S. Khurmi & J. K. Gupta □ Reference book.

National Conference on Current Trends in Engineering, Science and Technology (NACCTEST- 2018)
 Organized by GF's Godavari College of Engineering, Jalgaon
International Journal of Innovations in Engineering and Science, Special Conference Issue, 2018
www.ijies.net

Review on Design of Stationary Spindle Swaging Machine

Vaibhav Patil¹, Amol Mundokar², Yogendra Patil³, Swapnil Suryavanshi⁴, Samadhan Bhutekar⁵, K.M.Mahajan⁶

^{1,2,3,4,5} B.E. Student

^{1,2,3,4,5} Department of Mechanical Engineering, Gf's Godavari College of Engineering, Jalgaon, India, 425501.

⁶ Assistant Professor

⁶ Department of Mechanical Engineering, Gf's Godavari College of Engineering, Jalgaon, India, 425501

¹ Email:- veerpatil32@gmail.com

Abstract This project is purely based on Forming process. Basically, in forming process diameter or shape of work piece is reduces by external load which is applied by using manually or mechanically. The Rotary Swaging machine is the type of forming process. Rotary swaging is a process for precision forming of tubes, bars or wires. It belongs to the group of net-shape-forming processes, of which one of the characteristics is that the finished shape of the formed work pieces is obtained without, or with only a minimum amount of further final processing by machining. The forming dies of the swaging machine are arranged concentric around the work piece. The swaging dies perform high frequency radial movements with short strokes. Usually one die set consists of four die segments. The swaging dies rotate around the workpiece, or alternatively the workpiece rotates between the dies. For production of non-circular forms, the dies and the workpiece are stationary without rotational movement. Rotary swaging is an incremental forming process where the oscillating forming takes place in many small processing steps. One of the advantages of the incremental forming process compared to the continuous processes is the homogenous material forming.

This project gives us knowledge, experience, skills and new ideas of design and manufacturing. This project is the equipment useful to improve quality of swaging machine and overcome disadvantages of rotary

spindle and the output can be made in less time, hence we have selected this project. In rotary spindle swaging machine during working vibration on work piece is too much due high vibration work piece handling is very difficult but, In stationary spindle swaging machine overcome this drawback. The stationary spindle swaging machine allow multiple shapes on works piece. In this machine high product quality formed, and the efficiency of this machine is high.^[1]

Keywords- Base on Forming process, Reduce Diameter.

INTRODUCTION

Rotary swaging tooling rolling contact fatigue under operating conditions was investigated. First, rotary swaging tooling service conditions were identified in terms of load, speed, temperature, and lubrication. Secondly, analysis was conducted to characterize tooling materials and tooling contact fatigue mechanisms. Thirdly, computation was carried out to determine the load capacity of the rotary swaging machine, tooling dynamic load rating, tooling rolling contact fatigue life, Hertz contact stress and elasto hydrodynamic lubrication (EHL) analysis for oil film thickness. Finally tooling life improvement technologies were explored and discussed. Based on the results of experimental and computational work, typical tooling rolling contact fatigue and wear mechanism was determined, which consisted of surface brinelling, surface pitting, and crack growth. The

National Conference on Current Trends in Engineering, Science and Technology (NACCTEST- 2018)
 Organized by GF's Godavari College of Engineering, Jalgaon
International Journal of Innovations in Engineering and Science, Special Conference Issue, 2018
 www.ijies.net

primary cause for the rolling contact fatigue of tooling was contamination of the lubrication from swaging debris. Periodic overload and high contact stress also contributed to the tooling contact fatigue.

Rotary swaging is a process for reducing the cross sectional area of bars and tubes by repeated radial impact with dies, hammers and rollers. The main advantages of the process are manufacturing efficiency and flexibility, reduced part weight, reduced loss of work material, and improved overall productivity. Besides the capital cost of a rotary swaging machine, tooling is also a major cost of the process. As a result, it is important to analyse the tooling wear mechanism and improve tooling life with the aim of continuously improving productivity and reducing waste.^{[2] [4]}

METHODOLOGY

We will design stationary spindle swaging machine. Let fuses both form & functions in to a cost effective & convenient solution. Generally rotary spindle swaging machine is used in industry for forming process. In rotary swaging machine the die spindle is rotating with the help of motor & flywheel & casing is still stationary. In this machine, radially impact load & this load radially applied on dies with help of rollers.

Now if we have a circular rod & convert it into some another required shape as per the requirement specific die is required & insert that die into cavity of dies in machine. Then work piece is advances into the machine & radially impact load is applied on the work piece by dies through the rollers. As radial impact load is acted on the work piece then the forming process is occurred & required work piece shape is produced in output side of the machine. This is conventional type nonmetal removable forming process. But in this rotary machine, spindle is rotating & work piece is also rotating which causes jerk on operator's hand, work piece vibrations.

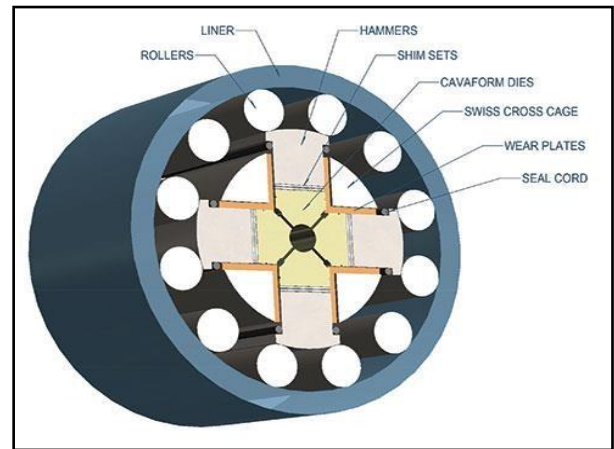

Fig.1- Spindle for Swaging machine

So to eliminate these drawbacks of rotary spindle swaging machine we discover to design the swaging machine with stationary spindle. In our design, spindle is stationary & outer casing of the spindle is rotating by motor with the help of flywheel. So due to stationary spindle, workpiece does not rotated in between dies. So the vibrations & jerk on operators hand is reduced. Due to stationary spindle, various shapes are produced as we required are formed. The main purpose of our project is to reduce vibrations on workpiece & produce multiple different shapes on work piece.^[3]

CONCLUSION

Based on the results of experimental and analytical work, typical tooling rolling contact fatigue and wear mechanism was determined, which consisted of surface brinelling, surface pitting, and crack growth. The primary cause for the rolling contact fatigue of tooling was contamination of the lubrication from swaging debris. Periodic overload and high contact stress also contributed to the pitting of tooling. Tooling life improvement technologies are currently being evaluated and implemented, such as debris filtration and analysis, tooling condition monitoring and increasing load rating of the swaging machine.^[5]

ACKNOWLEDGMENT

I take this opportunity to express my profound gratitude to my esteemed project guide Prof. K.M.Mahajan for his excellent guidance, suggestions and constructive criticism. Working under his guidance greatly contributed in improving quality of my project work and

National Conference on Current Trends in Engineering, Science and Technology (NACCTEST- 2018)
Organized by GF's Godavari College of Engineering, Jalgaon
International Journal of Innovations in Engineering and Science, Special Conference Issue, 2018
www.ijies.net

my Engineering skills. Actually he is one of such genuine person for whom my words will not be enough to express.

I am extremely fortunate to be involved in an exciting and challenging research project. This project has improved my thinking and understanding capability.

I am also thankful to Prof. V.H. Patil, H.O.D, Mechanical Engineering Department of Godavari College of Engineering, Jalgaon for his constant support and encouragement.

I wish to thank to Mr. Samir Sane HR manager of "S. HEATWELL Pvt Ltd" for his creative suggestions and valuable co-operation to accomplish the project work.

I also extend my sincere thanks to all faculty members of Mechanical Engineering department for making my project as successful one, for their valuable advice in every stage and also giving me absolute working environment where I unleashed my potential. I would like to extend my sincere thanks to my friends and colleagues.

I would like to convey my heartiest gratitude to my parents who deserve more recognition than I could ever acknowledge.

Last but not least I am indebted to many other such persons who have extended their hands of co-operation during my project. Although not mentioned in this acknowledgement, their names have been permanently engraved in my heart.

REFERENCES

- [17] ["Definition of swaging". Efund.com.](#)
Retrieved 2012-07-31.
- [18] [Jump up^ "Swaging machine capable of hot or cold work". Ameslab.gov.](#) Retrieved 2012-07-31
- [19] [Precision Composite Forging. Samtech.](#) Retrieved 22 November 200
- [20] [Rotary swaging Archived February 17, 2005, at the Wayback Machine](#)
- [21] *ASM Committee on Rotary Swaging, Rotary Swaging of Bars and Tubes, 1988, ASM Handbook, Vol. 14, Forming and Forging, pp. 128 - 144.*

National Conference on Current Trends in Engineering, Science and Technology (NACCTEST- 2018)
Organized by GF's Godavari College of Engineering, Jalgaon
International Journal of Innovations in Engineering and Science, Special Conference Issue, 2018
www.ijies.net

A Review on Design of Hydraulic Mold Splitter and Tipper Equipment

Mr. Abhyuday Joshi¹, Mr. Girish Patil², Mr. Lalit Rane³, Mr. Ravindra Patil⁴, Prof. Tushar Koli⁵

1,2,3,4 Students /

Department of Mechanical Engineering, Gf'S Godavari College of Engineering, Jalgaon, India, 425003

5Assistant Professor

Department of Mechanical Engineering, Gf'S Godavari College of Engineering, Jalgaon, India, 425003

¹Email:-joshiabhi815@gmail.com

Abstract - In the present review paper an effort is made to study the previous investigations that have been made in the different designs of hydraulic mold separators. This machine is purely based on hydraulics system. The machine which we are designing is useful to improve quality of mold being manufactured and can be made in less time. Now days, vertical machines of such type are present in industries which causes many difficulties during mold manufacturing. To reduce these kinds of difficulties, we are trying to improve this vertical machine and make it horizontal. Tasks which are too heavy or too delicate for human muscles to do can be done easily by this machine. The-use of this equipment has resulted in large-scale production and has reduced costs to levels never dreamt of before. Our core pull accessory is usually added to the housing of the tipper and this, of course, allows technicians to hydraulically work cores while the mold half is still in the Die-Sep, further saving time and energy from not having to move the mold for testing.

Keywords- Hydraulic mold separator, hydraulic systems, mold manufacturing, Die-sep, core pull accessories.

INTRODUCTION

Today's world requires speed on each and every field.

Hence rapidness and quick working is the most important. Now days for achieving rapidness we designed this machine. Hydraulic mold splitter and

tipper equipment is compact equipment and helps to manufacture molds with considerable higher rate. In short we can say that it will improve the quality production of molds. Mold splitters or separators allow

for safe and efficient handling of molds during maintenance, and can be built to the unique mold size, and plant configuration ^[1]. This project is purely based on hydraulics system. Pascal's law is the basis of hydraulic drive systems. The machine consists of two dies of which one is fixed while another is free to move. The pattern is mounted on one die and the mold to be manufactured is on second die. Both the dies can turn through 90 degrees, thus it becomes easy to inspect the defects and take out the manufactured mold from equipment.

METHODOLOGY

Following methodology is used for designing of Hydraulic mold splitter and tipper equipment ^[2]:-

- 1) **Formulation of the problem** – The success of any experiment is dependent on a full understanding of the nature of the problem.
- 2) **Consider the possible mechanisms** - When you designing the machine consider all the possible mechanisms which help desired motion or the group of motions in your proposed machine. From the various options the best can be selected whenever required ^[3].
- 3) **Transmitted forces** - Machine is made up of various machine elements on which various forces are applied. Calculate the forces acting on each of the element and energy transmitted by them.
- 4) **Material selection** - Select the appropriate materials for each element of the machine so that they can sustain all the forces and at the same time they have least possible cost.

National Conference on Current Trends in Engineering, Science and Technology (NACCTEST- 2018)
Organized by GF's Godavari College of Engineering, Jalgaon
International Journal of Innovations in Engineering and Science, Special Conference Issue, 2018
www.ijies.net

- 5) **Design of elements** – Find the size of each members of the machine by considering the force acting on the member and the permissible stresses for the material used. It should be kept in mind that each member should not defect or deform than the permissible limit.
- 6) **Modification** – Modify the size of the member to agree with the past experience and judgment to facilitate manufacturer. The modification may also be necessary by consideration of manufacturing to reduce overall cost.
- 7) **Production** – The component, as per the drawing, is manufactured in the workshop.

4. **Hydro power pack:-** A Hydro Power Pack is required to meet up with the power requirement of machine during operation.
5. **2/2 Solenoid valve:-** The directional control valve is used to pass on the pressure medium (i.e. flow) in an orderly fashion to a particular direction.

Table 1:- List of components and their quantity used in design

Sr. No.	Component Name	Quantity
1	Plummer Block	8
2	Hydraulic Cylinder	4
3	Hydro Power Pack	1
4	Dies	2
5	Circular Rod	2
6	Foot Step Bearing	4

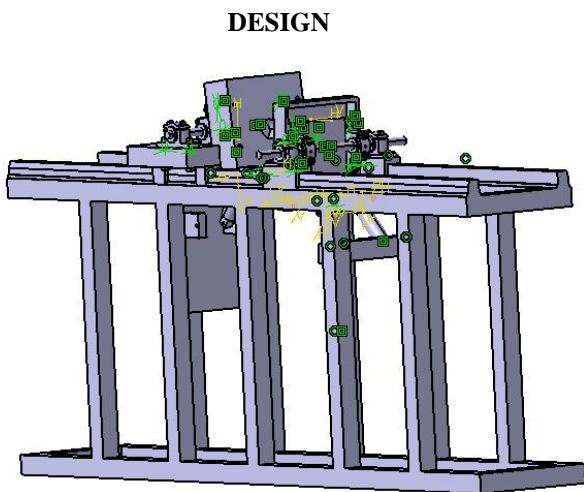

Fig1:- Design of hydraulic mold splitter and tipper equipment

This is entirely unique hydraulic mold splitter and tipper equipment that fuses both form and function in to a cost-effective and convenient solution. Whole the assembly in designed in CATIA V5R19. The main components of the machine are base table, dies, single acting hydraulic cylinders, hydro power pack, 2/2 solenoid valve.

1. **Base table:-** Base table is the one on which entire setup of the machine is mounted
2. **Die:** - Two dies of same dimensions are used on which molds were clamped.
3. **Single acting hydraulic cylinders:** - Four single acting hydraulic Cylinders are required for to and fro motion and tipping of dies through 90 degrees.

CONCLUSION

In the industries where the mold handling is taken place manually, there are high chances of accidents and injuries to the workers. Perhaps it reduces the productivity, accuracy and status of that particular company or industry in market. For this reason, we designed A Hydraulic Mold Splitter and Tipper Equipment. It will reduce the excessive labour work and also reduces the injuries from accidents to workers which in turns improve the productivity, quality, accuracy of the molds manufactured. Worker safety is an important reason for automating an industrial operation. Automated systems often remove workers from the workplace, thus safeguarding them against the hazards of the factory environment. As it is automated equipment hence there is no need of extra workers. This reduces the cost of wages given to the workers. It eliminates the damage to molds including parting line material damage caused by the insertion of pry bars. It reduces the amount of physical labor, in addition to making the tool room safer. Companies with this safety and labor saving device have a competitive advantage over their local competition in their attempts to hire and retain the more

National Conference on Current Trends in Engineering, Science and Technology (NACCTEST- 2018)
Organized by GF's Godavari College of Engineering, Jalgaon
International Journal of Innovations in Engineering and Science, Special Conference Issue, 2018
www.ijies.net

talented personnel. These personnel may include older, more experienced individuals who are no longer able to perform heavy manual labor on a daily basis.

4. V. B. Bhandari “*Design of Machine Elements*” third edition.

ACKNOWLEDGMENT

We take this opportunity to express our profound gratitude to our esteemed guide **Prof. Tushar A. Koli** for his excellent guidance, suggestions and constructive criticism. Working under his guidance greatly contributed in improving quality of our project work and our Engineering skills. Actually he is one of such genuine person for whom our words will not be enough to express.

We are extremely fortunate be involved in an exciting and challenging review paper. This paper has improved our thinking and understanding capability. We are also thankful to **Dr. V. H. Patil**, H.O.D, Mechanical Engineering Department of Godavari College of Engineering, Jalgaon for his constant support and encouragement. We wish to thank to **Mr. Tushar Chaudhari** owner of “KASTURI ENGINEERING WORKS” for his creative suggestions and valuable co-operation to accomplish this work. We also extend our sincere thanks to all faculty members of Mechanical Engineering department for making this paper as successful one, for their valuable advice in every stage and also giving us absolute working environment where we unleashed our potential. We would like to extend our sincere thanks to our friends and colleagues. we would like to convey our heartiest gratitude to our parents deserves more recognition than we could never acknowledge. Last but not least we are indebted to many other such persons who have extended their hands of co-operation during this paper work. Although not mentioned in this acknowledgement, their names have been permanently engraved in our heart.

REFERENCE

1. <http://www.diesep.com/>
2. <https://www.brighthubengineering.com/cad-autocad-reviews-tips/10214-machine-design-procedure/>
3. R. S. Khurmi and J. K. Gupta textbook of “*Machine Design*” first edition.

National Conference on Current Trends in Engineering, Science and Technology (NACCTEST- 2018)
 Organized by GF's Godavari College of Engineering, Jalgaon
International Journal of Innovations in Engineering and Science, Special Conference Issue, 2018
 www.ijies.net

Comparative Analysis of Metallic & Non Metallic Spur Gear – A Review

Shailendra Sakharam Wani¹, Dr. V. G. Arajpure²

¹PhD student

North Maharashtra University, Jalgaon, INDIA, PIN-425001

²Principal

G.F's Godavari College of Engineering, Jalgaon, INDIA, PIN-425003

¹Email:- swani2001@gmail.com

Abstract – Gears are the back bone & one of the most critical components in mechanical power transmission systems. Gears are the very useful components in mechanical power transmission system and industrial rotating machinery. A spur gear generally subjected to two types of stresses like bending stresses and contact stresses which are causes teeth failure during meshing with another tooth. Among the contributors in gear set failure bending and surface strength are identified as one of the contributors which plays major role in it. Thus, to reduce the failure of gear & for optimization of gear design analysis of stresses resulted into major are of interest. Gears are generally made from metallic materials but recently advanced polymers materials were developed which have sufficient strength and properties similar to the metallic materials so it can easily replace the metallic gears if some care will be taken. Nylon, polycarbonate, acetals and delrin are the structure polymers materials are used for gears in printing and robotics mechanism with good functionality but polymers gears are not used in heavy loading type application. Specially polymers gives extra benefits compared to metallic gears like less noise-vibration, low requirement of maintenance-lubrication, low cost and easy manufacturing. Static finite element analysis requires performing the design optimization process on both materials. This paper presents the design optimization methodology step by step for comparative analysis of metallic and polymer gears using static finite element analysis.

In this paper the major focus is on studying the comparative analysis of Metallic & Non-metallic spur gears.

Keywords: Metallic & Non metallic materials, bending stress, Polymer & hybrid materials, modeling,

INTRODUCTION

Gears are critical components of power transmission system. Gears are very useful due to its beneficial characteristic like constant velocity ratio & simple attachment for increase or decrease in speed of shaft. So it is widely used in most of power transmission system. Gears are made from following types of materials as per application:

- (a) Metallic material
 - (i) Malleable CI
- (b) Forged steel
 - (i) Carbon steel
 - (ii) Carbon chromium steel
 - (iii) Carbon manganese
 - (iv) Nickel chromium steel
- (c) Surface hardened steel
- (d) Case hardened steel
- (e) Non metallic & composite:
 - (i) Nylon
 - (ii) Acetals
 - (iii) Polycarbonate
 - (iv) Delrin

LITERATURE REVIEW

The literature mainly focuses on comparative analysis of various materials & studies the possibility about replacement of metallic gears with polymer gears of light or medium power transmission.

National Conference on Current Trends in Engineering, Science and Technology (NACCTEST- 2018)
Organized by GF's Godavari College of Engineering, Jalgaon
International Journal of Innovations in Engineering and Science, Special Conference Issue, 2018
www.ijies.net

(1) Maheebub Vohra, Kevin Vyas^[1]

In this paper a review of stress analysis of metallic & Non metallic spur gear is carried out. Various literatures which reviewed mainly focus on comparative analysis of various materials & study the possibility about replacement of metallic gears with polymer gears of light or medium power transmission. Design optimization methodology which is used here consist of following steps as Designing, modeling, Analysis & optimization using Agma-Lewis formula method & Computerized method.

(2) V.Siva Prasad, Syed Altaf Hussain, V.Pandurangadu, A.K. PalaniKumar.^[2]

In this paper, Design and analysis of spur gear and proposed to subtitle the metallic gears of sugar cane juice machine with Polymer gears to reduce the weight and noise. The main purpose of this paper to analyze the different polymer gears namely nylon, polycarbonate and their viability checked with counterpart metallic gear like as cast iron. By using the FEA methodology, they concluded that composite gears, if well designed and analyzed, it will give the useful properties like as low cost, noise, weight vibration and perform its operation similar to the metallic gears.

(3) Dr. Van Melick:^[3]

In this study, analysis was done by using finite element methodology for the influence of the stiffness and the bending of plastic gear teeth due to increase in the contact path length in a considerable change in load sharing. In the preliminary and prolonged contact, the involute tooth flanks do not mesh properly, but the tooth tips make a reciprocating movement on the root of the other root.

(4) Robert F. Handschuh, Gary D. Roberts, and Ryan R. Sinnamon.^[4]

Comparative FEA and experimental analysis was carried out in this study. Composite material was used as web of the gear between the gear teeth and metallic hub for the mounting to applying torque to the shaft, the web portion bonded at inner and outer hexagonal form.

This hybrid or composite gears are tested against an all steel gear. The hybrid gears operated successfully over 300 million cycles at 100 rpm and found that composite gears are 20% lighter than all steel gears. Vibration test also done on the composite gears and compared it with steel gears, results show that composite gears are produce less vibration than steel gears.

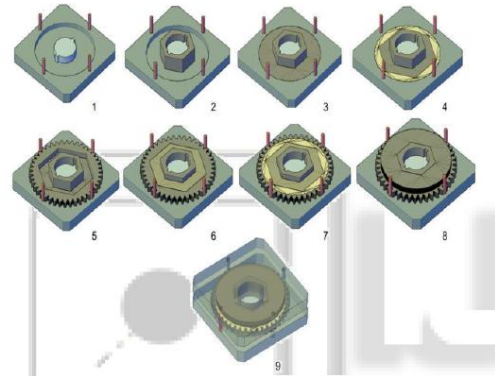

Fig:1- Hybrid Gear

(5) S. Senthilvelan and R. Gnanamoorthy:^[5]

Conduction monitoring conducted on the injection molded gears made of polymers, nylon and 20% glass filled nylon. By using Power absorption test ring, vibration and noise analysis for condition monitoring and found the possibility of early detection of gears tooth failures in case hardened spur gear. Also found that gear tooth surface temperature is increases and produce vibration at specific speed of rotation of the gears.

(6) Raymond M. Paquet :^[6]

Systematic methodology was carried for complex design process to develop injection molded plastic spur gear and helical gears with the help of computer system. The systematic design process provided the design parameters for load carrying capacity, adequate contact, balance tooth thickness and proper clearance value for gears so no any bending effect will occur at extreme operating conditions.

(7) Laurentia ANDREI1, Gabriel ANDREI1, Douglas WALTON:^[7]

This paper focus on the geometry of the tooth flank optimization. To determine the optimum value, gear tooth geometry changed and prepare gear solid model in computer software. Further this solid model imported in in analysis software to check the effect of loading on gear tooth by using a static finite element analysis. Here nonstandard plastic gear also discussed to optimize the gear.

(8) K Biernacki* and J Stryczek ^[8]:

The plastic gear used in getro pump has been analyzed by using FEA. Solid model of gear set developed and checked strength analysis of model by finite element analysis. According to this study, there are two parts in the mesh, one is active parts where intertooth forces are induced between the teeth of internal and external gear, second one is passive part where intertooth forces do not

National Conference on Current Trends in Engineering, Science and Technology (NACCTEST- 2018)
 Organized by GF's Godavari College of Engineering, Jalgaon
International Journal of Innovations in Engineering and Science, Special Conference Issue, 2018
www.ijies.net

occurred. The study concluded that gear deformation can be reduced in two ways first, by applying a higher strength plastic and second by modifying the cycloid gear set design.

(9) Gun-Hee Kim, Jeong-Won Lee, and Tae-Il Seo.^[9]

Durable characteristics analysis of worm wheel with glass reinforcement polyimide performed in this paper. Both analytical and experimental methods were carried out for prediction of characteristic of plastic worm wheel. Computer aided engineering analysis were executed with the polyimide resin reinforcement glass fiber. According to the result of this study, worm wheel of 50 % glass fiber reinforcement content was advantageous in terms of deformation, which has a great effort on the operation of worm wheel. When glass fiber reinforcement content increases, strength and hardness potentially improve but damage may result from shock due to fluctuating external forces as the brittleness also increase. It also concluded that distribution of glass fiber reinforcement is not even, the strength and hardness of the worm wheel tooth profile might change which changes the properties of gear tooth.

(10) Mrs. Shinde S.P., Mr. Nikam A.A., Mr. Mulla T.S.^[10]

Gear tooth generally subjected to two types of cyclic stresses, bending stresses inducing bending fatigue and contact stresses causing contact fatigue. This type of failure analysis was performed and trying to design spur gear tooth profile to resist bending failure so for this finite element model and studied method was performed to calculate the bending stresses. Two results analytical and computer software-ANSYS were compared for the comparative analysis of different tooth profile.

(11) Dr. Stefan Beermann.^[11]

This journal paper provides some guidelines to how evaluate the plastic gears and how to use design data for design and analysis of gear, also gives useful information about the measurement of material properties to make suitable for desire applications.

(12) Vineet Pandey.^[12]

Failure analysis of gear material presents the various types of failure produced in gear during the meshing of two teeth. It suggests that stress related failure due to stress concentration in gear tooth profile. Detail metallurgical analysis also conducted on the gear model and compares it with the new one gear in service condition. The study focus on the properties and limitation of industrial gear such as automobile and machinery to reduce the possibility of the gear. the thesis

also describes the complete experimental work on the gear to determine the hardness of gear material at specific condition, varying hardness properties due to the different heat treatment process. The thesis conclude that failure is produced in gear because gear might be used at higher working pressure than pressure given by manufacture specification and stress produces in gear also higher than safe or design limit. In general, most of the failure produced in gear due to the high stress, low cycle fatigue failure, abrasion wear and plastic deformation.

(13) Zeping Wei.^[13]

Stresses and deformation in involute spur gears by finite element method. investigates the characteristics of an involute gear system including contact stresses, bending stresses, and the transmission errors of gears in meshing condition. When two gears are mesh for transmitting power from one shaft to another shaft. During this meshing gears produce noise and vibration and it is due to effect of transmission error. The estimation of transmission error in a gear system, the characteristics of involute spur gears were analyzed by using the finite element methodology.

(14) Brenton L Ewing.^[14]

Analysis of a Hybrid (composite-metal) spur gear subjected to stall torque using the finite element method. presents the hybrid spur finite element analysis. Hybrid material is an assembly of different parts of composite and metallic material for the purpose of a reduction of weight of a spur gear. All metallic parts analyzed by using a static finite element method and compare the result with a convention stress formula. He also investigates about the stress analysis of a spur gear with holes in a gear surface for the reduction of a weight. This study concludes that hybrid material is 20% lighter in weight compared to the conventional metallic spur gear.

(15) John H. Chen & Frank M. Juarbe.^[15]

The use of Plastic Gearing is increasing steadily in new products. Nylons & acetals are the most widely used thermoplastic gear materials. They offer resiliency, resistance to wear & corrosion, noise reduction, vibration suppression, lightweight & requires minimum maintenance. This is due in part to the availability of recent design data. Fatigue stress of plastic gears as a function of diametral pitch, pressure angle, pitch line velocity, lubrication and life cycles are described based on test information. Design procedures for plastic gears are presented.

(16) Yong Kang Chen, Nick Wright, Chris J. Hooke, Stephen N. Kukureka.^[16]

National Conference on Current Trends in Engineering, Science and Technology (NACCTEST- 2018)
Organized by GF's Godavari College of Engineering, Jalgaon
International Journal of Innovations in Engineering and Science, Special Conference Issue, 2018
www.ijies.net

Plastics as gear materials represent an interesting development for gearing because they offer high strength-to-weight ratios, ease of manufacture and excellent tribological properties.

The failure mechanisms of polymeric (PA66 and PAM composite) gear have been investigated by testing plastic against plastic in counter-conformal, unlubricated, rolling-sliding contact over a wide range of slip ratios, loads and running speeds. Comparisons between tests on discs at varying slip ratios and the result of gear tests under comparable conditions have been very favorable. The wear and friction behavior of PA66 was dominated mainly by three major features: a critical slip ratio, under a fixed load and running speed, macro transverse cracks and a layer of film on the contact surface. These results corresponded closely to the failure phenomena of PA66 gears. It is suggested that the transverse cracks caused the plastic gear teeth to fracture, even near the pitch line. The macro transverse cracks in the gear teeth on the contact surfaces are serious disadvantages of PA66 gears.

OBJECTIVES OF THE WORK

Maheub Vohra & Prof. Kevin Vyas^[17] done following work as below

- Check comparative effect of produced stress in conventional metallic material of spur gears using a static finite element method.
- Check the non-metallic material using static finite element analysis.
- Check the stress analysis of gear parameter like as face width and module under loading condition.
- Check the possibility to replace metallic gear by other material like as polymer, composite or hybrid material for spur gear.

During the entire project, the Lathe machine headstock gears are used with following specifications

Table 1: Lathe Machine Specifications

Manufacture Name	Nataraj
Electric Motor	2 HP, 3 PH, 1440 rpm
Gear Type	Parallel Spur Gear
Pressure Angle	20°
Module	2

SOLID MODELING

Solid modeling is a representation of a real physical object without losing any properties of the real physical object would have for the design and analysis purpose. A solid model has a different properties like as density, mass, inertia and volume so it is very easy to understand about model of the physical object.

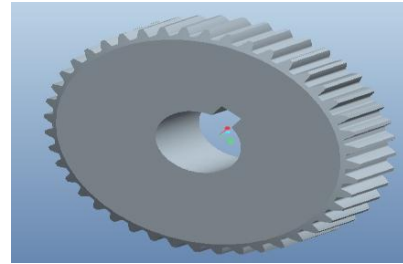

Fig:2- Gear Model

Cast Iron : (Metallic Material): Cast iron is a common material for the manufacturing of the gear. Cast iron is widely used due to its beneficial properties such as good wearing properties, low noise during power transmission, machinability and simplicity in producing complicated shape-smaller to bigger size by different casting method.

Table 2: CI Properties

Tensile ultimate stress	320-350 N/mm ²
Modulus of elasticity	1.65x10 ⁵ N/mm ²
Density	7.2x10 ⁻⁶ kg/mm ³
Poisson Ratio	0.25

NYLON (NON-METALLIC MATERIAL): Nylon is a generic designation for a family of synthetic polymers known generically as aliphatic polyamides which was first produced on February 28, 1935, in Wallace Carothers at DuPont's research facility at the DuPont Experimental Station. Engineering-grade nylon is processed by extrusion, casting, and injection moulding.

Table 3: Nylon Properties

Tensile ultimate stress	65 N/mm ²
Modulus of elasticity	2.20 GPa
Density	1.12 g/cc
Poisson Ratio	0.37

FEM STRESS ANALYSIS

Bending stress of spur gear teeth is generally calculated by analytically and finite element method. In this chapter, static finite element method is applied on the spur gear teeth for a different material of a spur gear. Analytical bending stress is calculated by two formula Lewis formula and AGMA formula. Analytical result is compared with the finite element method result for validation. von mises stress are equal to the tension stress and generally it is main cause of crack in the gear

National Conference on Current Trends in Engineering, Science and Technology (NACCTEST- 2018)
Organized by GF's Godavari College of Engineering, Jalgaon
International Journal of Innovations in Engineering and Science, Special Conference Issue, 2018
www.ijies.net

teeth if the load applied load is greater than strength of the gear teeth so gear teeth is crack from tensile force.

• Composite gears are also one way to replace metallic gears by polymer gears.

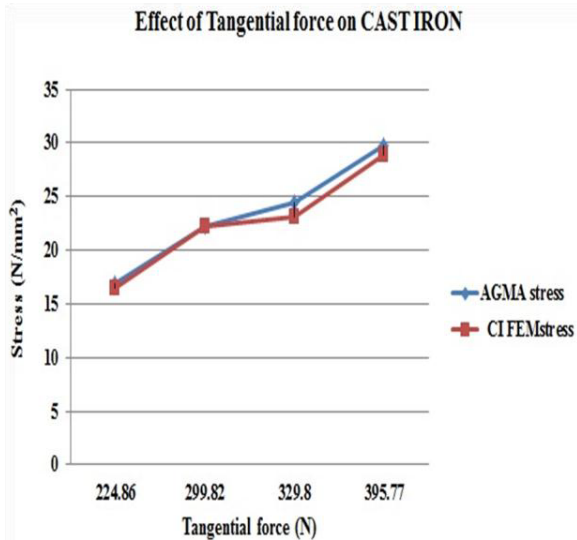

Graph 1: Effect of Tangential force on Cast Iron

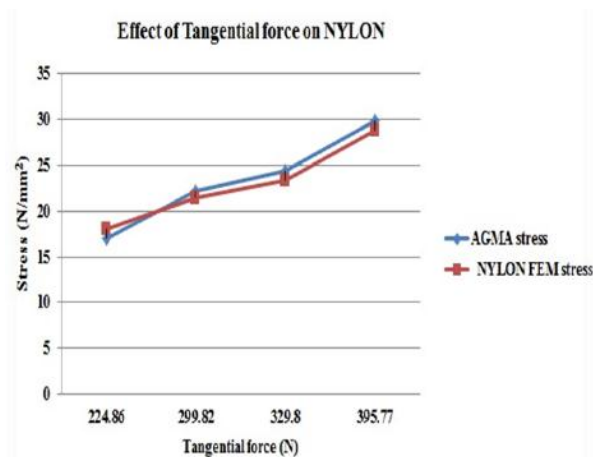

Graph 2 : Effect of Tangential force on Nylon

CONCLUSION

Based on analysis of various authors, following statement are states as under. ^[1]

- Now days, advanced polymer materials are developed which have same properties like high strength, wear resistance, less vibration and noise.
- Different structure polymers like Nylon, polycarbonate, acetal, delrin analyzed and compared to metallic gears.
- Stress-strain analysis results show that capability of replacing the metallic gears by polymer gears if sufficient care should be taken during designing.

According to Mahebur Vohra, Kevin Vyas^[17] Different material study provides the information for the bending stress of each material. Simulation result has good agreement with the theoretical result, which implies that deformable body is correct. This study provides a sound foundation for future studies on bending stresses. The study is applied in to finite element method software ANSYS. It was found that numerically obtained values of stress distributions were in good agreement with the theoretical results.

Nonmetallic material spur gear provides extra benefits like as less cost, self-lubricating, low noise, low vibration and easy manufacturing if it is used in limit of yield strength. It can be used in place of metallic gear in limit of yield strength of nonmetallic material.

REFERENCES

- [1] Mahebur Vohra, Kevin Vyas, "Design Stress analysis of Metallic and Non metallic Spur Gear – A Review", *IJSRD - International Journal for Scientific Research & Development* Vol. 2, Issue 04, 2014
- [2] V. Siva PrasadI, Syed AltafHussain, V.Pandurangadu, K.PalaniKumar, — "Modeling and Analysis of Spur Gear for Sugarcane Juice Machine under Static Load Condition by Using FEA", *Vol.2, Issue.4, July-Aug 2012 pp-2862-2866*
- [3] Dr. van Melick, "Tooth-bending effects in plastic gears. September/october 2007.
- [4] Robert F. Handschuh, Gary D. Roberts, and Ryan R. Sinnamon "Application of Composites to Dynamic Mechanical Components". NASA, NASA/TM—2012
- [5] S. Senthilvelan and R. Gnanamoorthy, "Condition Monitoring Of Nylon And Glass Filled Nylon Gears"
- [6] Raymond M. Paquet, *Plastic gearing technology,inc. " systematic approach to designing plastic spur and helical gears. November/Decemeber1989,gear technology-the journal of gear manufacturing.*
- [7] Laurentia ANDREII, Gabriel ANDREI, Douglas WALTON, "Optimisation of the tooth flank geometry for nonstandard spur gear. FASCICLE VIII, 2006
- [8] K Biernacki* and J Stryczek —Analysis of stress and deformation in plasticgears used in gerotor pumps.21 December 2009.
- [9] Gun-Hee Kim, Jeong-Won Lee, and Tae-Il Seo, —Durability Characteristics Analysis of Plastic Worm Wheel withGlass Fiber Reinforced Polyamide", *Materials* 2013.
- [10] Mrs.Shinde S.P., Mr. Nikam A.A., Mr. Mulla T.S. — "Static Analysis of Spur Gear Using Finite Element Analysis",.
- [11] Dr. Stefan Beermann, — "Estimation of lifetime for plastic gears".

National Conference on Current Trends in Engineering, Science and Technology (NACCTEST- 2018)
Organized by GF's Godavari College of Engineering, Jalgaon
International Journal of Innovations in Engineering and Science, Special Conference Issue, 2018
www.ijies.net

- [12] Vineet Pandey , P.G Thesis, *Failure analysis of Gear material, school of physics and material science, Thapar University, July 2009.*
- [13] Zeping Wei, "Stress and Deformation in Involute Spur gears by Finite Element Method", October 2004.
- [14] Brenton L Ewing, P.G Thesis, "Analysis of a Hybrid (composite-metal) spur gear subjected to stall torque using the finite element method", December 2013.
- [15] John H. Chen & Frank M. Juarbe. "The Design and Manufacture of Machined Plastic Gears. Part I. Design Parameters of Plastic Gears"
- [16] Yong Kang Chen, Nick Wright, Chris J. Hooke, Stephen N. Kukureka, "Failure Mechanisms in Plastic Gears", *Alternate gear manufacturing.*
- [17] Maheeb Vohra, Kevin Vyas, "Comparative finite element analysis of Metallic & Non metallic Spur Gear", *IOSR-JMCE, Vol-11, Issue-3, June-2014*

National Conference on Current Trends in Engineering, Science and Technology (NACCTEST- 2018)
Organized by GF's Godavari College of Engineering, Jalgaon
International Journal of Innovations in Engineering and Science, Special Conference Issue, 2018
www.ijies.net

Hybrid Multi-Pressure Distillation – Molecular Sieve Dehydration Technology: A Reliable Approach for Energy Optimization in Bioethanol Production Process

Dr. Nilesh P. Patil

Assistant Professor

*University Institute of Chemical Technology, North Maharashtra University, Jalgaon
Umavinagar, P. O. Box No. 80, Jalgaon-425 001 (Maharashtra), India*

Email: drnileshpatil@gmail.com

Abstract- As far as alternative energy sources are considered biofuels have potential to meet the ever increasing demand of energy sector. Amongst biofuels, ethanol has a great potential to come up as an environmentally clean fuel. The aim of this paper is to explore the different energy optimization for production of bioethanol. It was observed that heat integration is a key factor in intensification of bioethanol production process. Various factors like steam consumption and cooling water requirement when compared, reveals that heat integration is an important factor in deciding bioethanol production cost. It was observed that multi-pressure distillation as compared to its competitive techniques is a good alternative whereas multi-pressure distillation in combination with molecular sieve dehydration is even better from the energy optimization standpoint. In its current state steam requirement of bioethanol production process is 3.2 kg/liter of ethanol. The paper in detail elaborates how the steam requirement of the process could be reduced to 2.8 kg/liter of ethanol by using heat integration and flash steam generation.

Keywords- Energy Optimization, Multi-Pressure Distillation, Molecular Sieve Dehydration, Biofuels, Bioethanol.

1. Introduction

Now days increasing prices of crude oil, environmental impact of greenhouse gas emissions and world-wide warming trends caused by the emissions of greenhouse gases, demands the exploration of alternative energy sources ranging from solar, wind, and hydrogen to biomass. Since the transportation sector is one of the largest consumers of energy, it is necessary to find viable options to reduce the amount of harmful emissions produced from vehicles as well as the emissions produced from the production of fuel ^[1]. In average, 73% of produced ethanol worldwide corresponds to fuel ethanol, 17% to beverage ethanol and 10% to industrial ethanol ^[2]. From the vast literature survey, it is found that biofuels are the only alternative to have potential to cater the need of transportation sector with minimal impact on the environment. One of the major advantages of biofuels is that the biomass has direct effect with respect to carbon sequestration. The plants naturally absorb carbon from the atmosphere, aiding in the sequestration of carbon dioxide. Ethanol is found to have a great potential to come up as an environmentally clean transportation fuel. Traditionally, ethanol can be produced by catalytic conversion of ethylene and microbial fermentation.

But because of scarcity of petroleum feed stock and in abundance availability of renewable raw materials for fermentation, the fermentation process is more attractive than catalytic conversion process ^[3]. The Paper in detail elaborates comparative study of various techniques on

National Conference on Current Trends in Engineering, Science and Technology (NACCTEST- 2018)
Organized by GF's Godavari College of Engineering, Jalgaon
International Journal of Innovations in Engineering and Science, Special Conference Issue, 2018
www.ijies.net

the basis of heat integration, energy consumption and cooling water requirement, since these are the key factors that decide the production cost and in turn economics of the ethanol production process.

2. Fermentation

Ethanol is produced by the fermentation of molasses [4]. Sugar cane molasses is the main feedstock for ethanol production in India; cane juice is not presently used for this purpose [5]. Out of the several microorganisms yeasts *Saccharomyces Cerevisiae* are employed on large scale since they are found to have better viability for molasses. The ethanol fermentation can be carried out in batch, fed-batch or continuous mode [6-8]. The produced fermented with ethanol concentration of about 10-15% is then sent to distillation section. Adeniyi O. D. et al (2007) reported that cassava can also be used for the production of fuel ethanol [9]. Cellulosic biomass can also be used for the production of fuel ethanol [10].

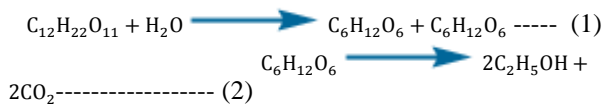

3. Techniques for Separation of Ethanol

In distillation section, the alcohol content of the wash is stripped of and ethanol of approximately 95.5% (w/w) concentration is recovered. Further concentration of ethanol using distillation is not possible because ethanol and water forms an azeotrope at this composition (95.6% ethanol). No number of distillations will ever result in a distillate that exceeds the azeotropic ratio. Further enrichment of ethanol must obviate the azeotropic point [3]. Different techniques are available for the recovery of ethanol from fermented wash. The objective of this work is to minimize the water content in the final ethanol product at a lower capital and energy cost compared to conventional technologies. One of the major costs contributing in the production of anhydrous ethanol is energy cost.

3.1. Atmospheric Distillation

The recovery of ethanol from fermented wash and its enrichment up to 95 % by weight is achieved solely by distillation; further enrichment of ethanol up to 99.5 % by weight to produce commercial ethanol is not possible by distillation since the ethanol water mixture form

homogeneous azeotrope at this composition. Further enrichment of ethanol must obviate the azeotrope point. To overcome this limitation and to obtain anhydrous ethanol, hybrid processes coupling simple distillation with azeotropic distillation, catalytic distillation, adsorptive distillation, multi-pressure distillation, membrane processes are often used [11]. Simple distillation is a seven column system, in which all the columns are operated at atmospheric pressure and each column are supplied with saturated steam to meet its heat requirement. The vapor coming from the top of each column are get condensed. In the absence of heat integration, the energy consumption of the process is found to be quite high resulting in the increased capacities of boiler and cooling tower. The major concern about atmospheric distillation is its high steam consumption and cooling water requirement. Moreover there are chances of scaling due to invert solubility of certain precipitating inorganic salts. All these things make the operation uneconomical. The highest ethanol concentration obtained by atmospheric distillation is 95.5%.

3.2. Azeotropic Distillation

In azeotropic distillation, a third component known as an entrainer is added to break up the binary ethanol-water azeotrope. Simple distillation followed by azeotropic distillation completely removes the water from the mixture to produce anhydrous ethanol of 99.5 % by weight. However, azeotropic distillation seems to be a very energy intensive process because ethanol must be distilled twice to recover the added third component. Parkinson reported that the energy required to enrich the ethanol from 95 % at azeotropic point to 100 % (pure anhydrous ethanol) requires about half the energy required in enriching ethanol from an initial 10 % ethanol mixture to 95 % at azeotropic point [12]. This process is also proved to be capital intensive because of the need for additional distillation columns. But use of carcinogens like benzene makes it a second choice.

3.3. Multi-Pressure Distillation

Multi-Pressure distillation is a seven column system in which two columns are operated at pressure, two at vacuum and the remaining three columns are at atmospheric pressure. In this technique only two columns operating at pressure are supplied with saturated steam while the remaining column runs on the vapors coming from the top of two pressurized columns

National Conference on Current Trends in Engineering, Science and Technology (NACCTEST- 2018)
Organized by GF's Godavari College of Engineering, Jalgaon
International Journal of Innovations in Engineering and Science, Special Conference Issue, 2018
www.ijies.net

resulting in the significant reduction in steam consumption and cooling water requirement as compared to atmospheric distillation. This technique is useful only for the production of potable grade alcohol. It was reported that vapor recompression is probably the best known arrangement for energy savings in distillation [13]. It is observed that heat integration reduces the energy consumption at least by 10 % of the total energy consumption and hence is the key for energy optimization in distilleries [14].

4. Pressure Swing Adsorption

Dehydration using molecular sieves is found to have a great potential to replace conventional dehydration processes and a good attempt in reducing energy consumption over conventional processes [15].

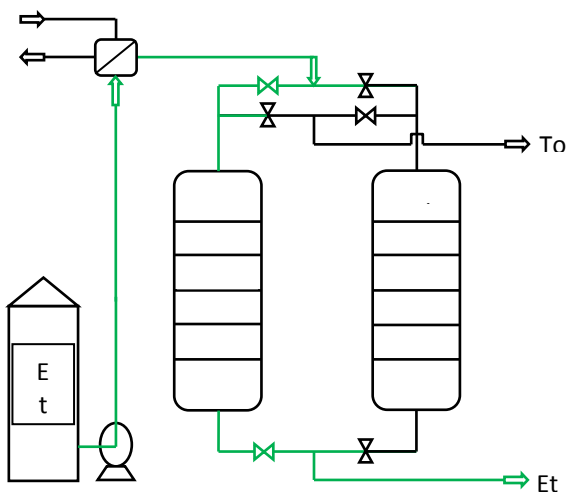

Figure.1 Symbolic Diagram of Molecular Sieve Dehydration

It operates on the principle of pressure swing adsorption [16]. As shown in Figure.1 Process consists of two adsorber beds filled with 3 Å Zeolite molecular sieves that are subjected to adsorption and desorption of water alternately. 3Å Zeolite based on its specific pore size retains the water molecules from vapors of ethanol water mixture, preventing the ethanol molecules to pass through it, since the micro pores are too small to be penetrated by alcohol molecules. During pressurized adsorption step water vapor is adsorbed on the molecular sieve and ethanol is condensed after leaving the adsorption column. During regeneration of the column water is removed by depressurizing the column and purging the bed with a portion of the purified ethanol vapor. This process is characterized by low steam and power consumption but requires high capital investment

[3]. Both liquid and vapor-phase adsorption are technically possible, but vapor-phase adsorption is usually preferred, which involves the evaporation and superheating of the ethanol water mixture prior to its exposure to the molecular sieve bed. Adsorption of water on the Zeolite is a strongly exothermic process. It was reported that a basic difference in membranes and molecular sieves used for water removal is that the productivity of a membrane system increases with water concentration, while the productivity of molecular sieves decreases with water concentration [17]. This is so because the flux through the membrane is proportional to the water concentration in the feed while the water holding capacity of a molecular sieve is finite.

5. Hybrid MPRD-MSD Process

This hybrid process is a combination of multi-pressure distillation and molecular sieve dehydration technology.

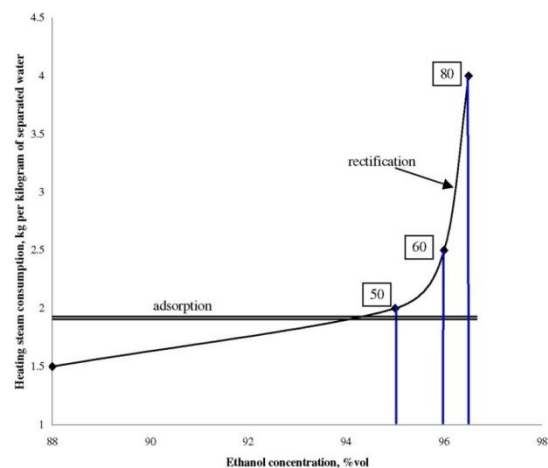

Figure.2 Energy Consumption in Rectification and Water Adsorption Process (Bremers et. al., 2010)
50 – Number of Plates in Rectification Section

From Figure.2, it is cleared that as the alcohol concentration in a rectified spirit increases beyond 95%, energy consumption is growing rapidly, approaching the infinite consumption at azeotropic concentration. In contrast, the energy consumption of water adsorption is independent of the alcohol concentration. The graph also shows that the energy consumption of alcohol dehydration solution upto 95% is less in rectification process, whereas above this concentration the energy consumption is more as compared to that of water adsorption. In this process rectifying achieves 96.5% alcohol concentration; one kilogram of water separation

National Conference on Current Trends in Engineering, Science and Technology (NACCTEST- 2018)
Organized by GF's Godavari College of Engineering, Jalgaon
International Journal of Innovations in Engineering and Science, Special Conference Issue, 2018
www.ijies.net

consumes 4.0 kg heating steam. If the congruent technology relationship between the rectification and adsorption of water be set so that upto 90% concentrations, use rectification whilst use water adsorption for further concentration, the heating steam consumption is only 1.8 kg per kilogram of separated water, that is about 55 % less. If 15 % energy savings are added from the waste water recirculation between the molecular sieves and the rectification column, the used congruent bioethanol dehydration technology can bring significant energy savings. The technology not only creates a basis for energy savings, but also simplifies the equipment design. It is known that the greater the reach of rectified alcohol concentration, the greater the number of stages (plates) required in the traditional rectification column. This, in turn, leads to increase the tower height. Figure.2 shows that for 95 % (V/V) alcohol concentration, the column requires 50 plates, while for 96.5 % (V/V) alcohol concentration reach; the column requires 80 plates.

6. Results and Discussion

In a distillery, ethanol is produced by the fermentation of molasses. Out of the capable microorganisms yeast *Saccharomyces cerevisiae* are largely employed in ethanol production using molasses. The ethanol concentration in the fermentation broth is about 10-15 %. Different techniques are available for the recovery of ethanol from fermented wash. Multi-pressure distillation alone concentrates the ethanol approximately upto 96.5% (w/w). Further concentration of ethanol from 96.5% - 99.5% is achieved by molecular sieve dehydration. But the combination of multi-pressure distillation with molecular sieve dehydration seems to be most reliable, convenient and economically optimized choice. Table.1 shows the comparative study of various separation techniques.

Table.1 Comparison of Operating Parameters

Sr. No.	Parameter	Atmospheric Distillation	Multi-Pressure Distillation	Molecular Sieve Dehydration	Hybrid MPRD + MSD
1	Product	Extra Neutral Alcohol	Extra Neutral Alcohol	Anhydrous Ethanol	Anhydrous Ethanol

			1	(Fuel Grade)	1 (Fuel Grade)
2	Distillation Column	07	07	00	03
3	No. of Distillation Column Required Steam	07	02	00	01
4	Adsorption Column	00	00	02	02
5	No. of Adsorption Column Required Steam	00	00	02	02
6	Enrichment of Ethanol (From – To) %	10 – 96.5	10 – 96.5	96.5 – 99.5	10 – 99.5
7	Steam Requirement kg/liter Ethanol	5.8 kg	3.20 kg	0.6 kg	2.0 kg
8	Steam Properties Requirement	1.5 +/- 0.05 kg/cm ² (g) at 128 ^o C	3.5 +/- 0.05 kg/cm ² (g) at 148 ^o C	3.5 +/- 0.05 kg/cm ² (g) at 148 ^o C	3.5 +/- 0.05 kg/cm ² (g) at 148 ^o C
9	Flash Steam Generation	NO	YES	NO	YES

National Conference on Current Trends in Engineering, Science and Technology (NACCTEST- 2018)
Organized by GF's Godavari College of Engineering, Jalgaon
International Journal of Innovations in Engineering and Science, Special Conference Issue, 2018
www.ijies.net

10	Heat Integration	NO	YES	YES	YES
11	Cooling Water Requirement	X* m ³ /hr	0.55X* m ³ /hr	0.1X* m ³ /hr	0.5X* m ³ /hr
*- X depends on case to case basis i.e. on plant capacity					

7. Conclusion

Considering all the facts associated with technologies available for the biotechnological production of ethanol, it is observed that Multi-pressure distillation alone concentrates the ethanol approximately upto 96.5% (w/w). Further concentration of ethanol from 96.5 - 99.5% is achieved by molecular sieve dehydration. But the combination of multi-pressure distillation with molecular sieve dehydration concentrates the ethanol from 10 - 99.5% with minimum energy consumption as compared to total energy consumption of the individual processes emerging as a most reliable, convenient and economically optimized choice. This hybrid technology brings down the energy consumption by 55% to its previous consumption^[18]. Different techniques are available for the recovery of ethanol from fermented wash. It was observed that multi-pressure distillation as compared to its competitive techniques is a good alternative whereas multi-pressure distillation in combination with molecular sieve dehydration is even better from the energy optimization standpoint.

References

- [1] Hoover, F. A., & Abraham, J. (2009). A comparison of corn-based ethanol with cellulosic ethanol as replacements for petroleum-based fuels: a review. *International Journal of Sustainable Energy*, 28(4), 171-182.
- [2] Sanchez, O. J., & Cardona, C. A. (2008). Trends in biotechnological production of fuel ethanol from different feedstocks. *Bioresource technology*, 99(13), 5270-5295.
- [3] Dirk-Faitakis, C. B., & Chuang, K. T. (2005). Simulation studies of the removal of water from ethanol by a catalytic distillation process. *Chemical Engineering Communications*, 192(11), 1541-1557.
- [4] Patil, N. P., Patil, V. S., & Bhole, S. L. (2016). Production of bio-ethanol from cane molasses: energy optimization through internal and external heat integration in distillation column. *Journal of Advanced Chemical Sciences*, 2(1), 215-218.
- [5] Ghosh, P., & Ghose, T. K. (2003). Bioethanol in India: recent past & emerging future. In *Biotechnology in India II*, Springer, Berlin, 1-27.
- [6] Rebros, M., Rosenberg, M., Grosova, Z., Paluch, M., & Sipocz, M. (2009). Ethanol production from starch hydrolyzates using *Zymomonas mobilis* and glucoamylase entrapped in polyvinylalcohol hydrogel. *Applied biochemistry and biotechnology*, 158(3), 561-570.
- [7] Patraşcu, E., Rapeanu, G., Bonciu, C., Vicol, C., & Bahrim, G. (2009). Investigation of yeast performances in the fermentation of beet and cane molasses to ethanol production. *Ovidius University Annals of Chemistry*, 20(2), 199-204.
- [8] Ghorbani, F., & Younesi, H. (2013). The kinetics of ethanol production from cane molasses by *Saccharomyces cerevisiae* in batch bioreactor. *Energy Sources, Part A: Recovery, Utilization, and Environmental Effects*, 35(11), 1073-1083.
- [9] Adeniyi, O. D., Kovo, A. S., Abdulkareem, A. S., & Chukwudozie, C. (2007). Ethanol fuel production from cassava as a substitute for gasoline. *Journal of Dispersion Science and Technology*, 28(4), 501-504.
- [10] Demirbaş, A. (2004). Ethanol from cellulosic biomass resources. *International journal of green energy*, 1(1), 79-87.
- [11] Van Hoof, V., Van den Abeele, L., Buekenhoudt, A., Dotremont, C., & Leysen, R. (2004). Economic comparison between azeotropic distillation and different hybrid systems combining distillation with pervaporation for the dehydration of isopropanol. *Separation and Purification Technology*, 37(1), 33-49.
- [12] Parkinson, G. (1981). Battelle maps ways to pare ethanol costs. *Chemical Engineering*, 88, 29.
- [13] Pribic, P., Roza, M., & Zuber, L. (2006). How to improve the energy savings in distillation and hybrid distillation- pervaporation systems. *Separation science and technology*, 41(11), 2581-2602.
- [14] Patil, N. P., Patil, V. S. & Bhole, S. L. (2016). Molecular sieve dehydration: a major development in the field of ethanol dehydration to produce fuel ethanol. *Asian journal of science and technology*, 7(5), 2897-2902.
- [15] Jeong, J. S., Jang, B. U., Kim, Y. R., Chung, B. W., & Choi, G. W. (2009). Production of dehydrated fuel ethanol by pressure swing adsorption process in the pilot plant. *Korean journal of chemical engineering*, 26(5), 1308-1312.
- [16] Pruksathorn, P., & Vitidsant, T. (2009). Production of pure ethanol from azeotropic solution by pressure swing adsorption. *Korean journal of chemical engineering*, 26(4), 1106-1111.
- [17] Cote, P., Roy, C., & Bernier, N. (2009). Energy reduction in the production of ethanol by membrane dehydration. *Separation Science and Technology*, 44(1), 110-120.
- [18] Patil, N. P., & Patil, V. S. (2016). Operational and economic assessment of distillation column from the performance of tray. *Int. J. Eng. Trend. Technol*, 4, 500-505.

National Conference on Current Trends in Engineering, Science and Technology (NACCTEST- 2018)
 Organized by GF's Godavari College of Engineering, Jalgaon
International Journal of Innovations in Engineering and Science, Special Conference Issue, 2018
 www.ijies.net

Design and Fabrication of Prototype Automatic Braking System and Pneumatic Bumper for Automotives

Prof.Y.J.Wagh¹, Dr.V.G.Arajpure², Prof.S.D.Galande³

¹Assistant Professor,
 AVCOE Sangamner, India, 422608

²Professor & Principal,
 Gf's GCOE, Jalgaon, India, 425001

³Assistant Professor,
 AVCOE Sangamner, India, 422608

¹Email:- yogeshwagh30@gmail.com

Abstract – Vehicle technology has increased rapidly in recent years, particularly in relation to braking system and sensing system. In parallel development of braking technologies, sensors have been developed that are capable of detecting physical obstacles, other vehicles or pedestrians around the vehicles. Automation can assure higher reliability of braking as compared to fully manual braking. Since high speed crashes are more likely to be fatal than low speed collisions, automatic braking systems can save lives and reduce the amount of property damage that occurs during accident. The concept is to improve the damage reduction capacity by adding an extendable and retractable bumper with an automatic braking mechanism. It will be an added safety measure in the current facilities such as Abs, Air Bags, etc. the use of pneumatic system can prove to be useful in automation due to its simplicity so the aim is design and developed a system based on automatic control of vehicles. This system improves response time of vehicles braking to keep safe distance between the vehicles, so we can obtain control over the speed of vehicle in short distance.

Keywords- Automatic braking system, pneumatic bumper, Electromechanical system, Infrared sensor.

A brake is a device which inhibits motion. Its opposite component is a clutch. Most commonly brakes use friction to convert kinetic energy into heat, though other methods of energy conversion may be employed. The effective braking depends mainly on the response time of the entire system and driver's feel. The response time is determined as the time elapsing between the beginning of the actuation of the control pedal and the moment the pressure in the actuator reaches 75 percent of its asymptotic value. The brake system layout configuration has to be designed in such a way that the response time should meet the vehicle safety standard regulations. The heavy commercial vehicle brake system layout is designed keeping various vehicle parameters like Gross Vehicle Weight, wheel base, Centre of Gravity of the vehicle, number of axles etc.

The system layout design is extremely complex since it involves number of valves which have to function in a logical sequence during different stages of braking (Normal, emergency, and One circuit failed condition).Conventionally, the system layout design is arrived after many iterations based on field trials and experience. This method involves more lead time and cost till the layout is finalized. Hence the modeling and analysis of the system layout using simulation helps us to predict the behavior of the layout in terms of response

INTRODUCTION

National Conference on Current Trends in Engineering, Science and Technology (NACCTEST- 2018)
Organized by GF's Godavari College of Engineering, Jalgaon
International Journal of Innovations in Engineering and Science, Special Conference Issue, 2018
www.ijies.net

and the effect of the individual subsystems, valves on the system behavior and thereby optimization study can be carried out. This tool employs bond graph technique and lumped system for developing physical based modeling. We studied the robust of pneumatic brake system in commercial vehicle using Simulation describes the modeling of system by simplifying the valves and the actuators. The modeling of foundation brakes compares the transient torque response of a typical disc brake for a heavy commercial vehicle. This model can be directly coupled to the vehicle models and the dynamics of the vehicle like stopping distance, stability can be studied. This model can also be used for design and optimization of brake system layouts for various heavy commercial trucks having varying wheel base and Gross Vehicle Weight.

Today India is the most important underdeveloped country in the world. India is the largest country in the use of various types of vehicles. As the available resources to run these vehicles like quality of roads, and unavailability of new technologies in vehicles is cause for accidents. The number of peoples which are dead during the vehicle accidents is also very large as compared to the other causes of death. Though there are different causes for these accidents but proper technology of braking system and technology to reduce the damage during accident are mainly affecting on the accident rates. So today implementation of proper braking system to prevent the accidents and pneumatic bumper system to reduce the damage is must for vehicles. To achieve this system modification goal, we design this Automatic Braking with Pneumatic Bumper System.

METHODOLOGY

The below methodology shows the sequential operation/steps that performed during the project process:

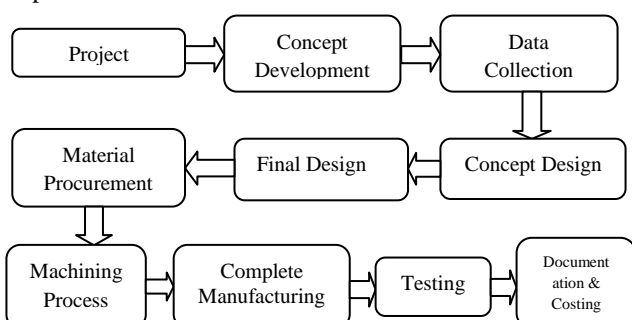

CONSTRUCTION

Automatic braking: Automatic braking is a technology for automobiles to sense an imminent collision with another vehicle, person or obstacle; or a danger such as a high brake or by applying the brakes to slow the vehicle without any driver input. Sensors to detect other vehicles or obstacles can include radar, video, infrared, ultrasonic or other technologies. GPS sensors can detect fixed dangers such as approaching the stop signs through a location database. Automatic braking by the system after sensing an obstacle can be executed in two modes. In collision avoidance, the collision is avoided by the automatic braking, but the driver will not be warned in this type of system. There is a very good chance of wrongly interpreting the signals, especially in the case of radars or lasers. So this is not so effective method of automatic braking. In collision mitigation system, the sensors detect the possibility of collision but will not take immediate action. A warning will be sent to the driver in the form of a signal or a voice message. There is a threshold safe distance calculated by the system and if the driver fails to respond even when the vehicle crosses that region, then only brakes will be applied automatically. Many vehicles are provided with the option of turning on or off the automatic system based on their surroundings. In some automobiles even though they cannot be completely disabled, they can be limited to warning the driver about coming obstacle. Even this emergency braking initiates ABS which helps the driver to retain the control over vehicle without any skidding. Automatic braking system is only effective if the mode of sensing the obstacles is reliable, or else any kind of false interpretation may cause a lot of damage.

Vehicle Bumper: A bumper is a structure attached or integrated to the front and rear of an automobile to absorb impact in a minor collision, ideally minimizing repair costs. Bumpers also have two safety functions: minimizing height mismatches between vehicles, and protecting pedestrians from injury. Modern design practice is for the bumper structure on automobiles to consist of a plastic cover over a reinforcement bar made of steel, aluminum, fiberglass composite, or plastic. Specialized bumpers, known as "bull bars" or "root

National Conference on Current Trends in Engineering, Science and Technology (NACCTEST- 2018)
 Organized by GF's Godavari College of Engineering, Jalgaon
International Journal of Innovations in Engineering and Science, Special Conference Issue, 2018
 www.ijies.net

bars", protect vehicles in rural environments from collisions with large animals. However, studies have shown that such bars increase the threat of death and serious injury to pedestrians in urban environments, because the bull bar is rigid and transmits all force of a collision to the pedestrian, unlike a bumper which absorbs some force and crumples. In the European Union, the sale of rigid metal bull bars which do not comply with the relevant pedestrian-protection safety standards has been banned.

A bumper that protects vehicle components from damage at 5 miles per hour must be four times stronger than a bumper that protects at 2.5 miles per hour, with the collision energy dissipation concentrated at the extreme front and rear of the vehicle. Modern theories of vehicle crash worthiness point in the opposite direction, towards vehicles that crumple progressively. A completely rigid vehicle might have excellent bumper protection for vehicle components, but would offer poor occupant safety. Bumpers are increasingly being designed to mitigate injury to pedestrians struck by cars, such as through the use of bumper covers made of flexible materials. Front bumpers, especially, have been lowered and made of softer materials, such as foams and crushable plastics, to reduce the severity of impact on legs. Bumpers offer protection to other vehicle components by dissipating the kinetic energy generated by an impact. This energy is a function of vehicle mass and velocity squared. The kinetic energy is equal to $1/2$ the product of the mass and the square of the speed. Kinetic energy $KE = \frac{1}{2}mv^2$ & the impact force is given by the equation $F = \frac{1}{2}mv^2/V$ Where, m = mass of the automobile V = velocity of the automobile s = braking distance.

1. Double acting cylinders: Cylinders are linear actuators which convert fluid power into mechanical power. They are also known as JACKS or RAMS. Gas is an expensive; it is dangerous to use pneumatic cylinders at high pressures so they are limited to about 10 bar pressure. Consequently they are constructed from lighter materials such as aluminum and brass. Because gas is a compressible substance, the motion of a pneumatic cylinder is hard to control precisely. The basic theory for hydraulic and pneumatic cylinder is same. Parameters consider during the design of cylinder.

Piston diameter (mm) : 32,40,50,63,80,100

Std Stroke(mm): 25,50,80,100,125,160,200,250,300,320
 Medium: Compressed air-filtered-lubricated
 Medium Temp.: 5°-60°C
 Working Pressure: 0.5-10 bar
 Considering Double Acting Cylinder of,
 Piston Dia. (D) = 25mm
 Stroke Length (L) = 80mm
 Dia. of Rod (d) = 10mm



Fig.1- Double acting cylinder

2. Pneumatic pipe fittings: Pneumatic tubing is also available in a number of other materials both with and without reinforcement for use in standard applications. SMC fittings incorporate a positive tube seal while the fitting is under pressure which allows polyurethane tubing to be used. Tubing is available in sizes of 1/8", 5/32", 3/16", 1/4", 5/16", 3/8", and 1/2". Metric tubing sizes of 3.2, 4, 6, 8, 10, 12, and 16mm are available. Polyurethane Tubing : TAU, TCU, TFU, TIUB, TU This can be used for connection of pneumatic system with total drill assemble.



Fig.2- Pneumatic hoses and fittings

3. 5/2 Solenoid valve: A valve is a device that regulates the flow of fluid (gases, liquids, fluidized solids or slurries) by opening and closing or partially obstructing passage ways. A 5/2 way directional valve from the name itself has 5 ports equally spaced and 2 flow positions. It can be use to isolate and simultaneously bypass a passage way for the fluid which for example should retract or extend a double acting cylinder. There is variety of ways to have this valve actuated.

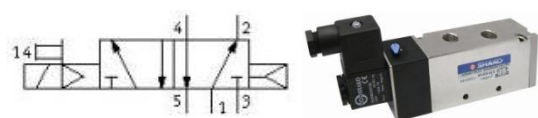

Fig.3- 5/2 solenoid valve

4. Pneumatic connectors, reducer and hose collector: In our pneumatic system there are two types of connectors

National Conference on Current Trends in Engineering, Science and Technology (NACCTEST- 2018)
Organized by GF's Godavari College of Engineering, Jalgaon
International Journal of Innovations in Engineering and Science, Special Conference Issue, 2018
www.ijies.net

used; one is the hose connector and the other is the reducer.



Fig.4- Hose Collector & Connector

5. IR transmitter and IR receiver sensor: The IR transmitting circuit is used in many projects. The IR transmitter sends 40 kHz (frequency can be adjusted) carrier under 555 timer control. IR carriers at around 40 kHz carrier frequencies are widely used in TV remote controlling and ICs for receiving these signals are quite easily available. The transmitted signal reflected by the obstacle and the IR receiver circuit receives the signal and giving control signal to the control unit. The control unit activates the pneumatic breaking system, so that break was applied.



Fig.5- IR sensor

6. Disc brake: A disc brake is a type of brake that uses calipers to squeeze pairs of pads against a disc in order to create friction that retards the rotation of a shaft, such as a vehicle axle, either to reduce its rotational speed or to hold it stationary.



Fig.6- Disc brake

7. Pedestal bearings: This type of bearing consists of i) a cast iron pedestal, ii) gun metal, or brass bush split into two halves called "brasses", and iii) a cast iron cap and two mild steel bolts. The detailed drawing of a pedestal bearing is shown in image below. The rotation of the bush inside the bearing housing is arrested by a snug at the bottom of the lower brass. The cap is tightened on the pedestal block by means of bolts and nuts. The detailed part drawings of another Plummer block with slightly different dimensions are also shown in image below.



Fig.7- Pedestal bearing

8. Shaft: Shaft is a common and important machine element. It is a rotating member, in general, has a circular cross-section and is used to transmit power. The shaft may be hollow or solid. The shaft is supported on bearings and it rotates a set of gears or pulleys for the purpose of power transmission. Material for Shafts: The ferrous, non-ferrous materials and non-metals are used as shaft material depending on the application.



Fig.8- shaft

9. 12Volt Battery: An electric battery is a device consisting of one or more electrochemical cells that convert stored chemical energy into electrical energy. Each cell contains a positive terminal, or cathode, and a negative terminal, or anode. Electrolytes allow ions to move between the electrodes and terminals, which allows current to flow out of the battery to perform work.



Fig.9- 12Volt Battery

DESIGN

For designed parts detailed design is done and dimensions there obtained are compared to next dimensions which are already available in market. This simplifies the assembly as well as the post production and maintenance work. The various tolerances on work are specified. The process charts are prepared and passed to manufacturing stage. The parts to be purchased directly are selected from various catalogues and are specified so as to have case of procurement In mechanical designed at the first stage selection of appropriate material for the part to be designed for specific application is done. This selection is based on

National Conference on Current Trends in Engineering, Science and Technology (NACCTEST- 2018)
Organized by GF's Godavari College of Engineering, Jalgaon
International Journal of Innovations in Engineering and Science, Special Conference Issue, 2018
www.ijies.net

standard catalogues or data books; (PSG design data books), (SKF bearing catalogue) etc.

Motor power $P = \frac{1}{15}$ HP=50watt, N=60rpm.

Small pulley dia. d=20mm.

Big pulley dia. D=60mm.

Center dist-between two Pulleys C=200mm.

Shaft dia. d=20mm.

1. Motor selection: Thus selecting a motor of the following specifications

Single phase AC motor

Power = 1/15hp=50 watt

Speed= 60 rpm

Motor Torque

$$P = \frac{2\pi NT}{60}$$

T = 7.96 N-m

Power is transmitted from the motor shaft to the input shaft by means of an open belt drive,

Motor pulley diameter = 20 mm

IP shaft pulley diameter = 60 mm

Reduction ratio = 3

IP shaft speed = 60/3 = 20 rpm

Torque at IP rear shaft = 3 x 7.96 = 23.88 Nm

2. Design of belt Drive: Coefficient of friction = 0.23

Let, d= diameter of rope = 5 mm

Mass of belt per unit length is given by;

ρ = density of belt material = 950 kg/m³

m = 0.0285 kg/m

Velocity of rope is given by; $V = \frac{\pi dn}{60 \times 1000}$

V=0.078 m/s, Linear velocity

To find out tension in the belt is; $P = \frac{(F_1 - F_2) \times V}{1000}$

$$(F_1 - F_2) = 636.619 \text{ N} \quad (1)$$

Center distance between two pulleys of motor & pulleys output C=200mm.

$$\alpha = \sin^{-1} \frac{D-d}{2C}, \alpha = \sin^{-1} \frac{(60-20)}{2 \times 200}$$

$$\alpha = 5.739^\circ \text{ (In Degrees)}, \alpha = 0.10^\circ \text{ (In Radians)}$$

θ = Angle of lap of belt.

$$\theta = \pi - 2\alpha$$

$$\theta = 2.94^\circ \text{ (In Radians)}, \theta = 168.54^\circ \text{ (In Degrees)}$$

$$\frac{F_1}{F_2} = e^{\frac{\mu\theta}{\sin\beta}}$$

$$\frac{F_1}{F_2} = 7.97 \quad F_1 = 7.97 F_2 \quad (2)$$

Put Eq. (2) in Eq. (1)

$$F_2 = 91.3 \text{ N}, F_1 = 727.69 \text{ N}$$

Centrifugal force in belt is given by,

$$F_C = mv^2 \quad F_C = 1.73 \text{ N}$$

3. Shaft design: To find diameter of shaft by ASME code

For commercial steel shaft, Actual shear stress

$$\tau_{act} = 55 \text{ N/mm}^2$$

$$T = \frac{\pi}{16} \times \tau_{act} \times d^3$$

d= 9.033mm, select d= 20mm

4. Bearing selection: In selection of ball bearing the main governing factor is the system design of the drive i.e.; the size of the ball bearing is of major importance; hence we shall first select an appropriate ball bearing. As shaft diameter is 20mm to it & selected a pedestal ball bearing having shaft outer dia-20mm ball bearing to support the shaft of 20mm.

Total radial load on bearings are = F₁ + F₂ + Weight of disc brake + weight of shaft.

$$= 6.379 + 3.207 + 9.81 + 9.81$$

Total radial load on bearings = 29.209 N, Assume = 30 N

$$F_r = \frac{30}{2} = 15 \text{ N}$$

Equivalent dynamic load $P_e = V \times F_r \times K_a = 1 \times 15 \times$

$$1.5 = 22.5 \text{ N}$$

Bearing life is,

$$L^{10} = \frac{L_h \times 60 \times n}{10^6} = \frac{31500 \times 60 \times 4300}{10^6} = 8127 \text{ millions of}$$

revolutions.

$$L^{10} = \left(\frac{C}{P_e}\right)^{\frac{10}{3}} \quad C = 335.09 \text{ kN}$$

5. Design of Pneumatic Cylinder: Clavarino's equation for closed end cylinder at both ends. For ductile material, use to determine the thickness of cylinder.

Let, Material of the cylinder is Aluminum.

$$t = [r_i \times \sqrt{\frac{\sigma_t + (1 - 2\mu)P}{\sigma_t - (1 + \mu)P}}]$$

National Conference on Current Trends in Engineering, Science and Technology (NACCTEST- 2018)
Organized by GF's Godavari College of Engineering, Jalgaon
International Journal of Innovations in Engineering and Science, Special Conference Issue, 2018
www.ijies.net

S_{ut} = Ultimate tensile strength = 200N/mm²
 μ = Poisson's Ratio for the cylinder material = 0.29
 d_i = Inner diameter of cylinder = 25mm

Consider,

Double acting cylinder Ø25X75 (Diameter X Stroke)

r_i = 12.5mm

By assuming pressure in working cylinder is, $P = 3$ bar
= 0.3 N/mm²

So according to Clavarino's equation,

For closed end, cylinder at both ends to determine the thickness of cylinder.

Assume,

$p = 3$ bar = 0.3 N/mm², $\mu = 0.29$, $r_i = 12.5$ mm

$t = 0.03049$ mm.

By considering Factor of safety FOS = 1.5

$t = 1.5 \times 0.03049$ mm. = 0.0457mm.

Available thickness, $t = 0.25$ mm

Let, A = Force area of cross-section of piston

$$A = \frac{\pi}{4} D^2 \text{ mm}^2 = 490.87 \text{ mm}^2$$

A_{PR} = Force area of cross-section of piston on rod side

$$A_{PR} = \frac{\pi}{4} (D^2 - d^2) \text{ mm}^2 = 412.334 \text{ mm}^2$$

Time required to complete stroke is 2 second.

$$V = \frac{L}{t} = 37.5 \text{ mm/sec}$$

Piston force acting during forward stroke

$$F_a = p \times \frac{\pi}{4} D^2 = 49.087 \text{ N}$$

Piston force acting during return stroke

$$F_R = P \times \frac{\pi}{4} (D^2 - d^2) = 41.233 \text{ N}$$

6. Design of brake Cylinder: Clavarino's equation for closed end cylinder at both ends. For ductile material, use to determine the thickness of cylinder.

Let, Material of the cylinder is Aluminum.

$$t = [r_i \times \sqrt{\frac{\sigma_t + (1 - 2\mu)P}{\sigma_t - (1 + \mu)P}}]$$

S_{ut} = Ultimate tensile strength = 200N/mm²

μ = Poisson's Ratio for the cylinder material = 0.29 (std)

d_i = Inner diameter of cylinder = 40mm

Consider,

Double acting cylinder Ø40 X 10mm (Diameter X Stroke) $r_i = 20$ mm

By assuming pressure in working cylinder is, $P = 3$ bar
= 0.3 N/mm²

Assume,

$p = 3$ bar = 0.3 N/mm²

$\mu = 0.29$, $r_i = 20$ mm.

$$t = [20 \times \sqrt{\frac{200 + (1 - 2 \times 0.29)0.3}{200 - (1 + 0.29).3}}]$$

$t = 0.048$ mm

By considering Factor of safety FOS = 1.5

$t = 1.5 \times 0.048$ mm. = 0.07318 mm.

Available thickness, $t = 0.5$ mm

Piston dia = 40mm

Stroke dia = 10mm Piston rod dia = 12mm.

Let, A = Force area of cross-section of piston.

$$A = \frac{\pi}{4} D^2 \text{ mm}^2 = 1256.63 \text{ mm}^2$$

A_{PR} = Force area of cross-section of piston on rod side

$$A_{PR} = \frac{\pi}{4} (D^2 - d^2) \text{ mm}^2 = 1143.54 \text{ mm}^2$$

Piston force acting during forward stroke

$$F_a = p \times \frac{\pi}{4} D^2 = 376.989 \text{ N}$$

Piston force acting during return stroke

$$F_R = P \times \frac{\pi}{4} (D^2 - d^2) = 343.061 \text{ N}$$

Time required to complete stroke is 2 second.

Linear velocity of piston $V = \frac{L}{t} = 5 \text{ mm/sec}$

National Conference on Current Trends in Engineering, Science and Technology (NACCTEST- 2018)
Organized by GF's Godavari College of Engineering, Jalgaon
International Journal of Innovations in Engineering and Science, Special Conference Issue, 2018
www.ijies.net

WORKING

As this system is used at the time of emergency during work, in normal travelling of vehicle this system is off and it never impact on the normal working. When any obstacle, humans, animals or vehicle is came in front of the vehicle then the installed infrared sensor senses that obstacle. The range of distance between the vehicle and obstacle is variable. This range is varied according to the density of vehicles or humans on road. The received signal by IR sensor is provided to the control unit. This control unit operates the relay according to the input signal. The relay operated by control unit cut off the electric power supply given to the engine so the working of engine is stop. When the engine stops the working the motion of vehicle suddenly reduces. At the same time of working of IR sensor the driver also applied the brake so braking system works by two methods.

There is some incidence when the working of automatic braking works and engine running is also stop but due to the moment of inertia on vehicle tries to forward motion of the vehicle. This inertia motion cause for accident, during such incidence the driver also uses manual braking system. In this manual braking system limit switch is also installed below the brake pedal. By receiving the foot force of driver the limit switch activates and provides the signal to the solenoid control valve. Solenoid control valve opens port going towards the bumper system and brake shoes. This pneumatic force used to forward motion of the bumper. By receiving the impact of accidental force bumper try to deflects. The flexible nature of the bumper able to sustain the force and so the impact of this force on vehicle is reduces. When the external body is kept safe then there is no chance of inner damage.



Fig. 9- Actual prototype model of automatic braking system and pneumatic bumper.

CONCLUSION

Behind the designing of this system, our main aim is to improve the technique of prevention of accidents and also reducing the hazard from accidents like injury of humans, damage of vehicle, etc. The present work provides improved bumper protection system having many novel features including protection of a stopped or parked vehicle from damage caused by other vehicles attempting to park. We have also observed that the prototype manufactured is working with satisfactory conditions and our work is able to achieve all the objectives which are necessary.

While concluding this report, we feel quite fulfill in having completed the project assignment well on time, we had enormous practical experience on fulfillment of the manufacturing schedules of the working project model.

Although the design criterions imposed challenging problems, which were overcome by us due to availability of good reference books. The selection of choice raw materials helped us in machining of the various components to very close tolerance and thereby minimizing the level of balancing problem.

REFERENCES

- [1] J. T. Wang, *An extendable and retractable bumper, general motors corporation United states ,paper no. 05-0144,pp.1-9.*
- [2] S.Mithun, S.Mariappa & Suresh Gayakwad, *Modeling and simulation of pneumatic brake system used in heavy commercial vehicle, IOSR Journal of Mechanical and Civil Engineering (IOSR-JMCE) Volume 11,Jan. 2014, pp. 01-09.*
- [3] Katore S.R., Kadlag S.C., Mane P.V., Pawar G.V., Londhe B.C., *Automatic braking with pneumatic bumper system, International Journal Of Engineering, Education And Technology (ARDIJEET), ISSN 2320-883X, VOLUME 3, ISSUE 2, 01/04/2015,pp.1-5.*
- [4] Al Amir-khalili,ChrisBest,RyanCase,DanHendry,Kyle Morrison& Matt Zulak, *BrakeSafe: An Intelligent Assisted Reversal System,pp.1-16.*
- [5] Sammed M Kesti, Dhananjaykumar J Upadhye , Sumeet A Bastawade and WadkarRasikAdinath, *Design And Fabrication Of Automatic Pneumatic Bumper And Braking System For Four Wheeler, A National Level Conference and Technical Fest on 30th April 2016,pp.1-8.*

National Conference on Current Trends in Engineering, Science and Technology (NACCTEST- 2018)
Organized by GF's Godavari College of Engineering, Jalgaon
International Journal of Innovations in Engineering and Science, Special Conference Issue, 2018
www.ijies.net

- [6] *Shinde Abhijeet, Panase Prathmesh, Mr.Chemate Pravin, & Prof-Dhage S.K, Automatic Pneumatic Bumper-Braking System, IJSRD - International Journal for Scientific Research & Development, Vol. 4, Issue 01, 2016,pp.806-806.*
- [7] *Mr.NiveshThepade,Mr.LakhanThombare,&Prof.AshishUmbarkar, Intelligent Braking System with Automatic Pneumatic Bumper, IJSRD - International Journal for Scientific Research & Development/ Vol. 4, Issue 04, 2016,pp.24-27.*
- [8] *SrinivasaChari.V, Dr.venkatesh P.R, Dr.PrasannaRao N.S,Automatic pneumatic bumper and break actuation before collision, International Research Journal of Engineering and Technology (IRJET), Volume: 02 Issue: 04 July-2015,pp.1015-1023.*
- [9] *Kanwar J.S Gill, Roshan Kumar, Sushil Kumar. Designing and Fabrication of Electro-Pneumatic Trainer Kit International Conference of Advance Research and Innovation (ICARI-2015) pp. ISBN 978-93-5156-328-0*

National Conference on Current Trends in Engineering, Science and Technology (NACCTEST- 2018)
 Organized by GF's Godavari College of Engineering, Jalgaon
International Journal of Innovations in Engineering and Science, Special Conference Issue, 2018
 www.ijies.net

A Review on Design and Fabrication of Brush Making Machine

Nilesh Vishvasrao Suryawanshi¹, Rakesh Dhansing Pawara², SK. Altamash SK Qadir³,
 Shubham Sanjay Pate⁴, Prashant Ashok Patil⁵, Prof. Vijay S. Chavan⁶

^{1,2,3,4,5}B.E. Student

GF'S Godavari College Of Engineering Jalgaon, India 425003

⁶Lecturer,

Department of Mechanical Engineering GF'S Godavari College Of Engineering Jalgaon, India 425003

⁴Email:- shubhampate25@gmail.com

ABSTRACT : *In day to day life for cleaning we are using many sort of brush. Brushes can be categorised by their work and shapes. Some critical parts like bottles or any small necked or small entry passage type articles are very difficult to clean inside walls. Like a bottle it has very small opening, it required some sort of brush which can penetrate easily inside the bottle and again expands and rub the interior walls of bottle and clean it. To make cleaning work easy, we are making project "Design and Fabrication of Brush Making Machine." As per market demand for this kind of cleaning brushes, we try to make the machine to produce maximum brushes in prescribed time.*

The Brush Making Machine will so design that it should have minimum moving parts which maximise reliability. The main components of machine are to be selected from some standard parts which are used in regular machines so that for future repair and maintenance of machine will be easy.

The brush is to be made by using two main parts as raw material, first is galvanized steel wire for handle and second polystyrene for bristles.

INTRODUCTION

Brush:-

A brush is a tool with bristles, wire or other filaments, used for cleaning, grooming hair, make up, painting, surface finishing and for many other purposes. It is one of the most basic and versatile tools known to mankind, and the average household may contain several dozen varieties. It generally consists of a handle or block to

which filaments are affixed either parallel- or perpendicular-wise, depending on the way the brush is to

be gripped during use. The material of both the block and bristles or filaments is chosen to withstand hazards of its application, such as corrosive chemicals, heat or abrasion.

Manufacturing fashion:-

A common way of setting the bristles, brush filaments, in the brush is the staple or anchor set brush in which the filament is forced with a staple by the middle into a hole with a special driver and held there by the pressure against all of the walls of the hole and the portions of the staple nailed to the bottom of the hole. The staple can be replaced with a kind of anchor, which is a piece of rectangular profile wire that is anchored to the wall of the hole, like in most toothbrushes. Another way to attach the bristles to the surface can be found in the fused brush, in which instead of being inserted into a hole, a plastic fibre is welded to another plastic surface, giving the option to use different diameters of bristles in the same brush. Configurations include twisted-in wire (e.g. bottle brushes), cylinders and disks (with bristles spread in one face or radially).

Types of Brushes:-

It is categorised by, Removal of material (cleaning and polishing), Assortment of cleaning brushes, including bottle brushes, the action of these brushes is mainly in the tip of each flexible bristle which dislodges particles of matter. Toothbrush, Floor brush (yard brush, yard

National Conference on Current Trends in Engineering, Science and Technology (NACCTEST- 2018)
 Organized by GF's Godavari College of Engineering, Jalgaon
International Journal of Innovations in Engineering and Science, Special Conference Issue, 2018
 www.ijies.net

broom, hand brush), Scrubber, Shoe-polish brush (buffer), Curling brush (sport), Nailbrush, Milk-churn brush, Vacuum-



FIG 1: MUSHROOM BRUSH

cleaner brush, Vegetable brush (mushroom brush), Archaeology brush, Lavatory brush (toilet brush or slang bog brush), Clothes brush, a brush for removing detritus from clothing, Chip brush, Car-wash brush, Gun-barrel brush, Wire brush, Typewriter eraser brush, Dandy brush, for Horse grooming, Dishwashing brush, Bench-grinder brush, Chimney brush Bottle brush, Broom (long-handled brush), Assorted cosmetics and Make-up brushes, Make-up brushes, Paintbrush (house decoration), Paintbrush (fine art), Wall-paper brush, Shoe-polish brush (polish applicator), Nail-polish brush, Finger-print forensic brush, Pastry brush, Ink brush, Shaving brush, Gilding brush, Hair brush, Dog-grooming brush, Cat fur brush, Brush (electric), used on electrical motors, Brush drum sticks, Magnetic brush, Stippling brush (neither applies or removes material, but merely adds pattern), Medical sampling brush.

LITERATURE REVIEW

Bottle brushes have been designed mounted on metal handles which require the user to hold a jar or bottle in one hand and the bottle brush in the other thereby making its use cumbersome. The user must physically insert and rotates by hand the brush in an attempt to clean the inside surfaces of the bottle or jar. The effort is tiresome and in many cases the inner surfaces are not thoroughly cleaned. This can present a problem in those instances where the bottle is a bottle used for feeding babies and the remnant of content, a baby formula, can spoil. Contamination can occur when the bottle is again filled with formula and the content fed to a baby.

U.S. Pat. No. 4,502,176 provides a bottle brush which can be attached to the centre section of a double sink, thereby enabling an individual to wash bottles using one hand. But the individual still must physically place the bottle over the brush and rotate the bottle. This is no different than using a free brush when it comes to efficient and effective cleansing of the bottle.

U.S. Pat. Des. No. 334,287 illustrates a power driven bottle brush which could provide a more effective means to clean bottles. However, the design of the brush limits its use to a special type of bottle in order for the brush to be effective as a cleaning instrument. The design also would appear to require the use of a specially designed driver necessitating the purchase of the driver of limited application and the brush. Accordingly, there exists the need of a bottle brush which will efficiently and effectively clean bottles, such as baby bottles, while avoiding manual manipulation of the brush and one which can be driven by universal readily available drivers. The present invention comprises a flexible rod having a plurality of stiff bristles, preferably of nylon, at one end for contacting inside walls and base inner surface of a baby bottle. Connecting structure is provided on an opposite end of the rod to be received by a receptacle of a portable, hand-held food mixer and rigidly locked thereto for rapidly rotating the rod and the bristles to clean the inside walls and base inner surface of a baby Design and Fabrication of Brush Making Machine bottle. The connecting structure is a universal coupler for connection to a mating coupler of a portable, hand held electric food mixer. One object of the present invention is to provide a bottle brush which may be attached to common, readily available drivers, such as portable electric mixers without modification to the driver. Another object is to provide a bottle brush which may be purchased separate from a specific driver. Yet another object is to provide a bottle brush which can be rotated by a portable electric mixer and easily attached to and removed from the mixer. Still another object is to provide time and labour saving apparatus for cleaning bottles. Brushes used for cleaning come in various sizes. They vary in size ranging from that of a toothbrush, to the standard household version accompanied by a dustpan, to 36" deck brushes. There are brushes for cleaning tiny cracks and crevices and brushes for cleaning enormous warehouse floors. Brushes perform a

National Conference on Current Trends in Engineering, Science and Technology (NACCTEST- 2018)
 Organized by GF's Godavari College of Engineering, Jalgaon
International Journal of Innovations in Engineering and Science, Special Conference Issue, 2018
 www.ijies.net

multitude of cleaning tasks. For example, brushes lightly dust the tiniest figurine, they help scrub stains out of clothing and shoes, they remove grime from tires, and they remove the dirt and debris found on floors with the help of a dust pan. Specific brushes are used for diverse activities from cleaning vegetables, as a toilet brush, washing glass, cleaning tiles, and as a mild abrasive for

MATERIALS AND METHODS

3.1 Mechanism of Operation

This project has various different design paths to complete our product while meeting the majority objectives. This means we will have to implement and compare our different designs to insure the best product based on our set of objectives. These paths have changed as we progressed through our project, and there were a few foreseen methods that we expand upon in the design section.

The basic design for making brush making machine is just put bristles between two wires and twist them. The crucial part in the mechanism is to put bristles in wires and support it at the beginning of twisting process. Torque requirement to twist these two wires depends on wire gauge used for making brush.

1) Frame :-

Frame or supporting structure is to be made by MS flat and L-section bars. These bars are made from mild steel and they are hot rolled. This material gives a good tensile and compressive strength to frame and has a good machinability. By the further calculations we get the exact required length and dimension of section



Fig 3 :
Frame

2) Galvanised iron wire:-

G.I. wires are available in range 0.37 mm to 5.0 mm diameter, it consistent mechanical properties, uniform zinc coating, bright surface finish. These are mild

sanding. Designing and fabrication of brush making machine by automatically because of reducing the human effort .This type of brush making machine is easily operated. The Design and Fabrication of Brush Making Machine automatic operated machine is portable, movable and fixed It is handy operate, less power consumption and an only skilled worker required. Design and Fabrication of Brush Making Machine carbon or high carbon steel wires, which are coated with Zinc, so as to impart the base wire with superior properties. The Zinc coated galvanized wires are highly resistant to Moisture and mechanical damage (than other surface coatings), and have a very bright and smooth surface finish.



Fig. 2 : Galvanized Iron Wire

3) Plummer block:-

Plummer block housings can be used with high-capacity spherical roller bearings or self-aligning ball bearings. They are manufactured from high-strength cast iron as standard but are also available in cast steel or spheroidal graphite cast iron. The housings have a re-lubrication facility and can be used with either oil or grease lubrication. To ensure effective sealing, Plummer blocks are made with a variety of special sealing options and end covers. Benefits include a facility for easy mounting and dismounting of pre-assembled shafts.



Fig 4 : Plummer Block

MANUFACTURING, ASSEMBLY AND WORKING

Manufacturing and Assembly:-

First of all V cut a frame pieces of angle 25 into 25 mm of various lens as 760 mm two pieces 125 mm, two pieces 300 mm four pieces 100 mm three pieces using the angle pieces 760 mm and 125 mm we make one rectangular frame we can called as a beard and welded firmly also we build I legs for the frame which are at a distance of 245 mm from the ground after that we make a provision to install MS flat of width 25 mm and length 250 mm to support bristles file making brush we take MS flat of 25 mm width and 3 mm thickness and the length of 96 mm and make holes as per the mounting holes on the motor and make a notch between these two holes to facilitate assembling with motor retracting mechanism is made by the two square pipes which are 30 mm by 30 mm by 75 mm long and 25 mm by 25 mm and 140 mm long we can called as the two square pipes sliding inside each other we take two bolts and welded vertically on each end of each Pipe and connected using a tensile spring one of the end where gold is welded on a smaller square pipe we attach one hook which film struck the galvanized iron wire while manufacturing of brush and all this assembly of retracting mechanism is welded on one of the end of the frame at the other end by calculating the size of breast we make and drill chuck assembly also the universal joint and motor shaft and drilling chuck shaft we build a DC motor mounting plate here we use universal joint for eliminating any eccentricity between motor shaft and drill chuck after that we will firmly motor shaft to the actual shaft of motor also we weld drill chuck shaft with the drill chuck socket and all the assembly is to be made now it's a time to install pedestal bearing which will carry drill chuck shaft and the bearing is first time to the frame we have used 12 volt dc internal gearbox motor for the moving check to supply this motor we attach 12 volt AC transformer which is step down Transformer converting 230 volt AC into 12 volt AC power supply we place rectifier for making AC to DC conversion now we place a DPDT switch for operating a motor forward and reverse fashion and place this switch in a box and attached this box on the frame with the help of nut and bolt also we attach transformer on the frame.

Working:-

As the user going to make brush he will take a galvanized iron wire of appropriate length place it in the hook and the other end should be grasp in the drill chuck between the two wires he should place the bristles to make brush as he turn on motor in forward direction the

wire will twist and due to twisting the length of wire will decrease as we have installed retracting mechanism which is Spring loaded it will help to minimize the length of wire and the brush will made.

PROCEDURE TO MAKE BRUSH

- 1) First of all take a length of 640 mm galvanized iron wire from stack.
- 2) Take exact half of that wire and make U shape.
- 3) Now stuck the U shape in the hook and place bristles on the bristles holder.
- 4) Next step take the both ends of wire and insert in the check and lock it by tightening with chuck key.
- 5) Now hold your right hand on the bristles so that it will not move from its place and with the left hand push the forward button so that motor wheel rotate in the forward direction.
- 6) You will see the wire is started twisting, push and hold the forward direction button until you saw the whole wire is twisted properly and bristles are closer to each other.
- 7) Observe the retracting mechanism's spring is now in tension.
- 8) Release the forward direction button and push reverse direction button for half a second so that it will loose and easy to removal of brush.
- 9) Now unscrew the chuck and remove the brush from machine.
- 10) Your brush is ready to work for cleaning Bottles and pipes as per your wish.

ADVANTAGES & LIMITATIONS**Advantages:**

- 1) Required less effort.
- 2) This machine can be operate on battery.
- 3) Faster production rate.
- 4) It is cheap.

Limitations:

- 1) The machine not fully automatic needs one worker to operate continuously.
- 2) Highly skilled operator is required.

CONCLUSION

We have search in the market the various machines which are used to make this type of brush is very costly. From this project we design and make solution to manufacture the brush in cheap price. This type of brush are used for cleaning bottles, pipes etc.

During production we faced so many difficulties about alignment and power lost due to friction, to overcome this problem we decided to include universal joint between motor shaft and drill chuck shaft. By this solution the alignment problem is resolve in most extend. The motor we have used is a wiper motor of cars, the shaft of motor is very short and made by very hard material so we can't made even hole in that shaft in

our local industry. So we design the dummy shaft and welded it on original shaft.

The most and most horrible thing of this machine is to operate correctly. As the machine is fully manual, we found it required a highly skilled worker to make brush. Even we had tried so many times to make a perfect brush. We all learned to operate this machine and making the brush. Lastly in our local market we couldn't find the appropriate bristles, we search the whole city for bristles but was failed. After searching on internet we got the supplier from Mumbai and we order it from him.

REFERENCES

- [1] "Fan Tip Tube Brushes". *Thomas Scientific. Thomas Scientific. Retrieved 4 February 2016.*
- [2] Aggarwal, Chaitanya. "Chemistry Lab Instruments". *Rac Exports. IndiaMART IndiaMESH Limited. Retrieved 4 February 2016.*
- [3] "Nylon Sponge Tube Brush, 10" Handle, 3"L x 1.5" Dia Brush; 12/Pk". *Cole-Parmer® Fluid-handling and Analysis. Chemoscience (Thailand) Co., Ltd. Retrieved 4 February 2016.*
- [4] "Adjustable Test Tube Brush". *Laboratory Sales & Service LLC. Laboratory Sales and Service LLC. 2009. Retrieved 4 February 2016.*
- [5] "Babcock Cream Test Bottle Brush". *VWR® We Enable Science. VWR. Retrieved 4 February 2016*

Finite Element Analysis of Petrol Engine Crank Shaft-Review

Mr. Chandan. A. Patil¹, Mr.V.P.Kolhe², Bharat B.Waghode³

¹Lecturer in Mech Engg Deptt,

J.T.Mahajan,Polytechnic Faizpur, India 425524

²Lecturer in Mech Engg Deptt,

J.T.Mahajan,Polytechnic Faizpur, India 425524

³Lecturer in Mech Engg Deptt,

J.T.Mahajan,Polytechnic Faizpur, India 425524

³Email:- bharatwaghode7@rediffmail.com

Abstract-- The crankshaft plays a vital role in all Internal Combustion Engine. It is a large component, which is converts the reciprocating displacement of the piston to a rotary motion with a four link mechanism. It has complex shape of geometry. The crankshaft experiences a cyclic load, due to the cyclic load fatigue failure occur over a period. The fatigue analysis has to be considered in the design stage itself. The design and development of crankshaft is always been an important task for the production industry, in order to reduce the manufacturing cost of the product minimum weight possible and proper fatigue strength and other functional requirements. These improvements result in lighter and smaller engines with better fuel efficiency and higher power output.

The finite element analysis was performed in four static steps for each crankshaft. Stresses from these analyses were used for superposition with regards to dynamic load applied to the crankshaft.

Keywords: Crakshaft, FEA, ANSYS13.0.

I.INTRODUCTION

1.1CRANKSHAFT

The Internal combustion petrol engine are those that burn their fuel which is mixture of air and petrol from carburetor inside the cylinder. These engine convert the chemical energy stored in their fuel into heat energy during the power stroke of piston. The heat energy produced from burning of fuel is used for motion of piston. During Operation of four stroke of piston various parts engine is acted by different stress. Also some parts are undergone Deformation. All these stresses and deformation must be studied so that Petrol engine can be

designed by Optimum. The magnitudes, variations and exposure times for the stresses and temperatures experienced are the major factors controlling the lives engine components in service. The role of stress analysis is to calculate these quantities so that component service lives can be predicted. Currently the dynamic analysis of the internal combustion engine for a given configuration and specifications is most widely conducted using a physical test rig. Though the analysis of in-process stress is very much difficult owing to the complications of the system and the temperature of the piston and cylinder assembly..All these process are manually operated therefore itis time consuming. Dynamic analysis of the IC engine can also be performed using dynamic simulation software like MSC ADAMS, MATLAB Sim-Mechanics, ANSYS and the results of the dynamic analysis can then be imported into a FEA software which can solve for structural solutions like stress, deformation.

After years of steady, conventional model changes, the automobile engine industry is in the midst of the most powerful product changeover in its history. To accomplish the need to design a sensible engine, the structural engineer will need to use imaginative concepts. The demands on the automobile designer increased and changed rapidly, in every respect of design and engineering. The main and foremost part of the engine is a crankshaft which is used to propel the vehicle ahead which must be able to accomplish all the design requirements whether structural or vibration.

Till recently crankshaft stress analysis was done by the empirical formulae and iterative procedures, but the simplifying assumption that a throw of crankshaft has one degree of freedom is only partially true for torsional modes of vibrations. More degrees of freedom are required to get information about other modes of vibration and stress distribution. Since last decade advent of powerful finite element analysis (FEA)

packages have proven good tool to accurately analyze them. The complicated geometry of crankshaft and the complex torque applied by cylinders make their analysis difficult. But optimized meshing and accurate simulation of boundary conditions along with ability to apply complex torque, provided by various FEA packages have helped the designer to carry stress analysis. FEA enables to find critical locations and quantitative analysis of the stress distribution and deformed shapes under loads. However detailed modeling and specialized knowledge of FEA theory are indispensable to perform these analyses with high accuracy. They also require complicated meshing strategies. Simulation of actual boundary conditions to equivalent FE boundary conditions have to be done carefully because a wrongly modeled boundary condition leads to erroneous results. The solution of such large scale FEA problem requires both large memory and disc space as computing resources. But a few researches have carried for the complete analysis using FEA. The analysis becomes a CAE analysis, if FEA is to be used. The basic literature available is provided by Jouji Kimura presented the correlation between the crankshaft torsional vibrations and the dynamic stresses at the front and rear fillets of the first crankpin under operating conditions. R.Heath explains simple modeling techniques and discusses simulation of boundary conditions. P.Seshu also analyze the crankshaft torsional vibration using finite element analysis. V. Prakash discusses simulation of boundary conditions. The theory of dynamic analysis and the practical approach using these theories. Hans H. Mullar-Slany had given stress concentration factors, these were used for crankshaft fillet stress analysis.

Since fatigue crack initiation and fracture at the fillets is one of the primary failure mechanisms of automotive crankshafts, the fillet rolling process has been used to improve the fatigue life of crankshafts for many years. The fillet rolling process induces compressive residual stresses within the fillet surface. The compressive residual stress lowers the fatigue driving forces due to operating loads near the fillet surface and consequently increases the fatigue life of the crankshaft. Without any dimensional modification, the fatigue life of a crankshaft could be improved significantly by applying various surface treatments.

This paper concentrates on both experimental and analytical modal analysis of a crankshaft. Analytical work involved the development of a three-dimensional FE model. A modal analysis was performed to provide frequencies and mode shapes. Results of the FE modal analysis were compared with those obtained from the EMA.

1.2 FUNCTIONS OF CRANKSHAFT IN I.C.ENGINES

The crankshaft, connecting rod, and piston constitute a four bar slider-crank mechanism, which converts the sliding motion of the piston (slider in the mechanism) to a rotary motion. Since the rotation output is more practical and applicable for input to other devices, the concept design of an engine is that the output would be rotation. In addition, the linear displacement of an engine is not smooth, as the displacement is caused by the combustion of gas in the combustion chamber. Therefore, the displacement has sudden shocks and using this input for another device may cause damage to it. The concept of using crankshaft is to change these sudden displacements to a smooth rotary output, which is the input to many devices such as generators, pumps, and compressors.

1.3 CRANKSHAFT MATERIALS

Crankshafts materials should be readily shaped, machined and heat-treated, and have adequate strength, toughness, hardness, and high fatigue strength. The crankshafts are manufactured from steel either by forging or casting. The main bearing and connecting rod bearing liners are made of Babbitt, a tin and lead alloy. Forged crankshafts are stronger than the cast crankshafts, but are more expensive. Forged crankshafts are made from SAE 1045 or similar type steel. Forging makes a very dense, tough shaft with a grain running parallel to the principal stress direction. Crankshafts are cast in steel, modular iron or malleable iron. The major advantage of the casting process is that crankshaft material and machining costs are reduced because the crankshaft may be made close to the required shape and size including counterweights. Cast crankshafts can handle loads from all directions as the metal grain structure is uniform and random throughout. Counterweights on cast crankshafts are slightly larger than counterweights on forged crankshafts because the cast metal is less dense and therefore somewhat lighter. Generally automobile crankshafts were forged in past to have all the desirable properties. However, with the evolution of the nodular cast irons and improvements in foundry techniques, cast crankshafts are now preferred for moderate loads. Only for heavy duty applications forged shafts are favored.

1.4 MODELLING THE CRANKSHAFT

In this research, the crankshaft details are studied. The crankshaft has four crankthrows, three rod journals and two main journals, and it is modelled in CATIA as per the dimensions and figure of the model is shown below in Fig.1

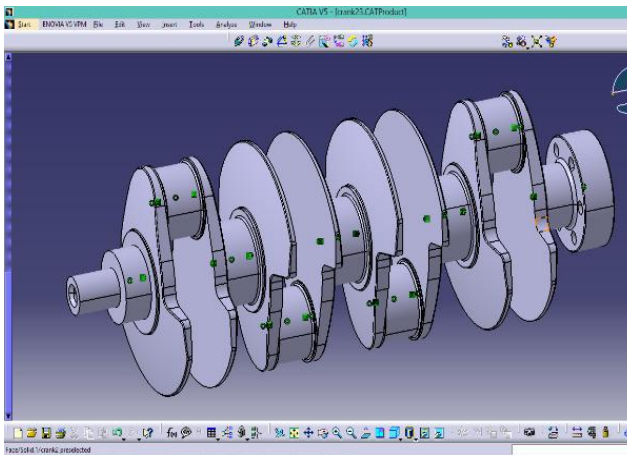

Figure 1: Modelling of Crankshaft

II. LITERATURE SURVEY

B D N S Murthy, N S Teja Kollati, (2013), The modelling and analysis of a 4-cylinder crankshaft is discussed using finite element method in this paper. The analysis is done on two different materials which are based on their composition. 3-D model of engine crankshaft was created using CATIA V5 R19 software. The finite element analysis (FEM) software ANSYS 14.0 was used to analyse the static and modal analysis of the crankshaft. The maximum stress and deformations are found by analysing the crankshaft. The results would provide a valuable theoretical foundation for the optimization and improvement of crankshaft of an engine.

Dr. K.H. Jatkar, Mr. Sunil S. Dhanwe, (2013), studied a dynamic analysis of single cylinder petrol engine was conducted. Finite element analysis was performed to obtain the variation of the stress magnitude at critical locations of connecting rod and crankshaft. The dynamic analysis resulted in the development of the load on piston. This load is calculated from MATLAB. This load was then applied to the FE model and boundary conditions were applied according to the engine assembly. It is observed that maximum stress is developed at crank pin of crank shaft. The maximum stresses are developed at the fillet section of the big and the small end of connecting rod. Hence, the project deals with the stress analysis of connecting rod and crankshaft by Finite Element Method using ANSYS WORKBENCH 11.0 Software. Also Results obtained from the analysis were then compared with analytical method. Static analysis of a connecting rod that is typically performed can yield unrealistic stresses, where dynamic analysis provides more accurate results better suited for fatigue design and optimization analysis of this high volume production component. The stresses induced in the small end of the connecting rod are greater than the stresses induced at the big end. Therefore, the chances of failure of the connecting rod may be at fillet section of both ends. The bending stress

produced as a result of dynamic loading is significant and bending stiffness in the shank should be considered as an important design factor.

Farzin H. Montazersadgh and Ali Fatemi, (2007), investigates finite element analysis was performed to obtain the variation of stress magnitude at critical locations. The pressure-volume diagram was used to calculate the load boundary condition in dynamic simulation model, and other simulation inputs were taken from the engine specification chart. The dynamic analysis was done analytically and was verified by simulation in ADAMS which resulted in the load spectrum applied to crank pin bearing. This load was applied to the FE model in ABAQUS, and boundary conditions were applied according to the engine mounting conditions. The analysis was done for different engine speeds and as a result critical engine speed and critical region on the crankshaft were obtained. Stress variation over the engine cycle and the effect of torsional load in the analysis were investigated. Results from FE analysis were verified by strain gages attached to several locations on the crankshaft. Results achieved from aforementioned analysis can be used in fatigue life calculation and optimization of this component. Dynamic loading analysis of the crankshaft results in more realistic stresses whereas static analysis provides an overestimate results. Accurate stresses are critical input to fatigue analysis and optimization of the crankshaft. There are two different load sources in an engine inertia and combustion. These two load sources cause both bending and torsional load on the crankshaft. The maximum load occurs at the crank angle of 355° for this specific engine. At this angle only bending load is applied to the crankshaft.

R.B.Sharma & Vikas Sharma, (2013), investigates dynamic & static behaviour of automotive engine crankshaft with the specific conditions. This work investigates the coupled modes, including couple torsional flexural vibration and coupled longitudinal flexural vibration for non-rotating engine crankshaft. The finite element models of this generally used are in two categories beam elements and solid elements and in this study the solid element category is being used. By using this model the natural frequencies and mode shapes of the engine crankshafts are determined by the FEM. by applying the specific load, the stress analysis of engine crankshaft is carried out by Finite element method. This study is useful to predict the safe values of dynamic as well as static behaviour of engine crankshaft. This study entails the dynamic behaviour and the static behaviour of the engine crankshaft under the different respective conditions. The first case is of about the dynamic analysis, precisely saying that it was a natural frequency analysis to know the range of the natural frequency, which lies in between 186.75Hz to 667.67Hz for various modes.

Sanjay B Chikalthankar, V M Nandedkar, et al, (2013), investigate stresses developed in crankshaft under dynamic loading. In this study a dynamic simulation was conducted on crankshaft, Finite element analysis was performed to obtain the variation of stress magnitude at critical locations. The pressure-volume diagram was used to calculate the load boundary condition in dynamic simulation model, and other simulation inputs were taken from the engine specification chart. This load was then applied to the FE model, and boundary conditions were applied according to the engine mounting conditions. The analysis was done for different engine speeds and as a result we get critical engine speed and critical region on the crankshaft. Stress variation over the engine cycle and the effect of torsional load in the analysis were investigated. The maximum deformation appears at the center of crankpin neck surface. The maximum stress appears at the fillets between the crankshaft journal and crank cheeks, and near the central point journal. The edge of main journal is high stress area. Dynamic loading analysis of the crankshaft results in more realistic stresses whereas static analysis provides overestimated results. Accurate stresses are critical input to fatigue analysis and optimization of the crankshaft. Considering torsional load in the overall dynamic loading conditions has no effect on Von Mises stress at the critically stressed location. The effect of torsion on the stress range is also relatively small at other locations undergoing torsional load. Therefore, the crankshaft analysis could be simplified to applying only bending load.

III.THEORY

3.1 IMPLEMENTATION

Crankshaft is one of the most critically loaded components and experiences cyclic loads in the form of bending and torsion during its service life. It must be strong enough to take the downward force of the power stroked without excessive bending. This crank shaft is very difficult to analyze directly because of its complex structure. It is possible to analyze the vibrational nature of crankshaft by using finite element software. The experimental modal analysis means the extraction of modal parameters i.e. (frequencies and mode shapes) from measurements of dynamic responses.

3.2 FEA APPROACH

The finite element method is a numerical method which can be used for the accurate solution of complex mechanical and structural vibration problems. In this method, the actual structure is replaced by several pieces or elements, each of which is assumed to behave as a continuous structural member called a finite element. The elements are assumed to be interconnected at certain

point known as joints or nodes. Since it is very difficult to the exact solution of the original structure under the specified loads, a convenient approximate solution is assumed in each finite element. During the solution process, the equilibrium of forces at the joints and the compatibility of displacement between the elements satisfied, so that entire model is made to behave as a single entity. In this FEA analysis, whole crankshaft finite element model is used, applying the bending force acting on the crank of three cylinder inline engine, reaction forces acting on the on all the main journal bearings & torsional moment is applied on each crank separately, The value of Bending & torsional force was obtained from the dynamic simulation of the crankshaft for whole 7200 rotation of the crankshaft. Applying the respective forces on each cylinder as got from the firing order of the cylinders.

It is not always possible to obtain the exact analytical solution at any location in the body, especially for those elements having complex shapes or geometries. Always the most important are the boundary conditions and material properties. In such cases, the analytical solution that satisfies the governing equation or gives extreme values for the governing functional is difficult to obtain. Hence for most of the practical problems, the engineers resort to numerical methods like the finite element method to obtain approximate but most probable solutions. Finite element procedures are at present very widely used in engineering analysis. The procedures are employed extensively in the analysis of solids and structures and of heat transfer and fluids, and indeed, finite element methods are useful in virtually every field of engineering analysis.

3.2.1 DESCRIPTION OF THE METHOD

In any analysis we always select a mathematical model of a physical problem and then we solve that model. Although the finite element method is employed to solve very complex mathematical models, but it is important to realize that the finite element solution can never give more information than that contained in the mathematical model.

3.2.2 PHYSICAL PROBLEMS, MATHEMATICAL MODELS, AND FINITE ELEMENT SOLUTION

The physical problem typically involves an actual structure or structural component subjected to certain loads. The idealization of the physical problem to a mathematical model requires certain assumptions that together lead to differential equations governing the mathematical model. The finite element analysis solves

this mathematical model. Since the finite element solution technique is a numerical procedure, it is necessary to access the solution accuracy. If the accuracy criteria are not met, the numerical solution has to be repeated with refined solution parameters (such as finer meshes) until a sufficient accuracy is reached. It is clear that the finite element solution will solve only the selected mathematical model and that all assumptions in this model will be reflected in the predicted response. Hence, the choice of an appropriate mathematical model is crucial and completely determines the insight into the actual physical problem that we obtain by the analysis. Once the mathematical model has been solved accurately and the results have been interpreted, we may well decide to consider next a refined mathematical model in order to increase our insight into the response of the physical problem. Furthermore, a change in the physical problem may be necessary, and this in turn will also lead to additional mathematical models and finite element solutions. Figure 1 depicts the process of finite element analysis. The key step in engineering analysis is therefore choosing appropriate mathematical models.

Fig.2 depicts the process of finite element analysis. The key step in engineering analysis is therefore choosing appropriate mathematical models.

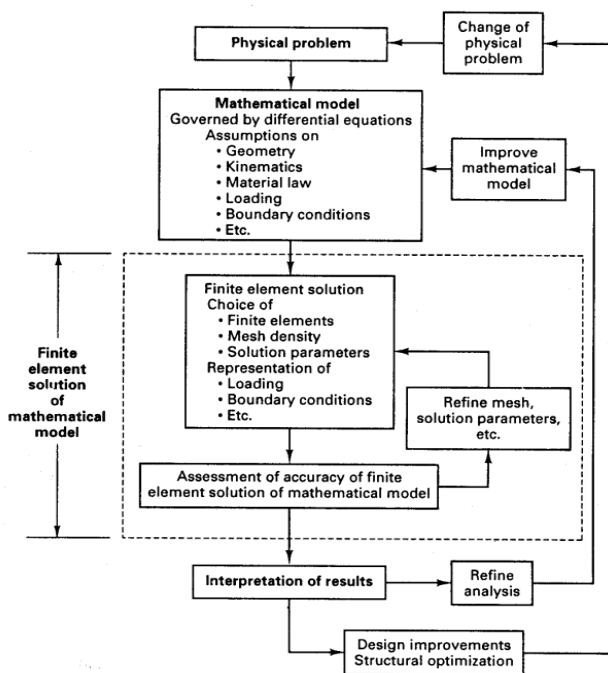

Figure 2: Flow chart for component Design and Optimization

3.3 THREE PHASES OF ANALYSIS

For determining stresses and deflections the following steps of the analysis are essential:

1. Preparation of input data: The requisite data for the given problem is geometry (i.e. 3D model), material properties and boundary conditions (i.e. loads and constraints).
2. Solution: This involves solving the necessary equations to calculate the unknown parameters.
3. Arrangements of results: The results obtained for stress analysis may be presented in the form of tables or graphical images like stress patterns, displacement patterns.

3.4 FINITE ELEMENT MODELING AND ANALYSIS

1 Preprocessing: This phase consists of making available the input data such as geometry, material properties, meshing of the model, boundary conditions and has the following steps:

- i. Set up: Here we enter the analysis type, the material properties, and the geometry (i.e. prepare the model). The model may be built parametrically or a model from other software package can be imported.
- ii. Create FE model: In this step we divide the total volume into small simple regular volumes, which can be easily meshed. Then we define the mesh size for each small volume by virtually dividing all the edges of the small volume into same divisions.
- iii. Loading: In this step the boundary conditions are imposed, i.e. forces and constraints, on the model are defined.

2 Solution: In this phase a solver is used to solve the basic equation for the analysis type and to compute the results. This phase is taken care by the software programme. In the solution process, the solver goes through following steps to compute the solution for a steady state analysis. 1. Formulate element matrices. 2. Assembly and triangularise the overall stiffness matrix. 3. Calculate the solution by back substitution. 4. Compute the stresses, displacements etc.

3 Postprocessing: This is the last phase where the results are reviewed for the analysis done, by obtaining graphic displays, vector-plots and tabular reports of stress and displacement, etc. It may take

long time to solve or analyze the whole model. Therefore the system used in such complex problem should have high configuration

3.5 FEA OF CRANKSHAFT

3-D finite element analyses were carried out on the crankshaft. FEA software ANSYS was used to simulate the stress analysis of the crankshaft. A 3D fine meshed model with boundary condition is shown in Fig 3. The results of natural frequencies and stresses were obtained. The results are regarded as a theory basis to optimize the design of crankshaft and analysis the structure dynamics of crankshaft. Crankshaft is a complicated continuous elastomer. The stresses developed in crankshaft have important effect to the engine. The calculation of the stresses in crankshaft is difficult because of the complexity of crankshaft structure and difficult determinacy of boundary condition. The boundary conditions are the critical factors for the correctness of calculation. The boundary conditions in the crankshaft model consist of load boundary condition and restriction boundary condition. The mechanics boundary conditions mainly involves: gravity, centrifugal force, crankpin neck surface force, various bending moment and torque, etc. Gravity, centrifugal force, various bending moment and torque can apply to the model with the distributed force, ANSYS software simulates the effects of gravity and centrifugal force itself based on the given gravity accelerative, angular velocity, density and physical dimension.

Modal analysis of a system, deals with determination of natural frequencies, mode shape and amplitude through the vibration testing. In the case of forced vibration, the analysis includes the study of acceleration, velocity and displacement responses of the systems.

The load applying on the crankpin surface is supposed as distributed load. The distributed load along the crankpin axis is a quadratic parabola distribution and along the radial direction within 120°. Pressure versus crankshaft angle diagram is used to calculate the forces at crankpin and is shown in Fig.4. Although the pressure plot changes for different engine speeds, the maximum pressure which is much of our concern does not change and the same graph could be used for different speeds. The dynamic analysis resulted in angular velocity

and angular acceleration of the connecting rod and forces between the crankshaft and the connecting rod.

There are two different load sources acting on the crankshaft rotating components such as connecting rod, applies force to the crankshaft and this force increases with the increase of engine speed. This force is directly related to the rotating speed and acceleration of rotating components. The second and the main load source is the force applied to the crankshaft due to combustion of the fuel in the cylinder. The slider-crank mechanism transports the pressure applied to the upper part of the slider to the joint between crankshaft and connecting rod. This transmitted load depends on the dimensions of the mechanism. Forces applied to the crankshaft cause bending and torsion.

MODAL ANALYSIS

Modal analysis is the identification of vibration characteristics of elastic structures. It consists of describing a system by its modal parameters; natural frequencies, mode shape and amplitude. This study enables better understanding of vibration phenomenon encountered in engineering its purpose is to get data from experiment in order to determine system characteristics. One can use the data in several ways, depending on the aims to reach.

Another way of using the information provided by modal analysis is to obtain a frequency response function (FRF) from the theoretical model and real test structure and to compare both results this comparison allows, correcting the model to a certain extent by using a trial and error approach.

In this section, we present a modal analysis made with crankshaft by finite element analysis, analytical method using the theory of the equivalent model and the experimental test of the specimen. A comparison of the obtained results by these methods was also presented. The purpose of this study is to determine the natural frequencies, the modes shape and amplitude of 3-cylinder petrol engine crankshaft.

A modal analysis determines the vibration characteristics (natural frequencies and mode shapes) of a structure or a machine component. It can also serve as a starting point for another, more detailed, dynamic analysis, such as a transient

dynamic analysis, a harmonic response analysis, or spectrum analysis. The natural frequencies and mode shapes are important parameters in the design of a structure for dynamic loading conditions. Same set command is used for modal analysis that used in any other type of finite element analysis. Likewise, choose similar option from the graphical user interface (GUI) to build and solve models.

Steps involved in modal analysis:

A. Build the model

This step includes the job name and analysis title and then uses PRER7 to define the element types, element real constant, material properties, and the model geometry.

B. Apply loads and obtain the solution

In this step, define analysis types and options, apply loads, and satisfy load step options to get the finite element solution for the natural frequency.

C. Expand the modes

Specify the number of mode that, you have to expand. If frequency range is selected, only modes within that range mode results are appeared.

D. Review the results

Results from modal analysis are written to the structural results file. Results consist of natural frequency, mode shape relative stress. Those results wish to see, database must contain the same modal for which the solution was calculated.

3.6 EXPERIMENTAL MODAL ANALYSIS

In this, we will make FRF measurements with a FFT analyzer, modal excitation techniques, and modal parameter estimation from a set of FRFs (curve fitting). Experimental modal parameters (frequency, damping, and mode shape) are also obtained from a set of FRF measurements. The FRF describes the input-output relationship between two points on a structure as a function of frequency. Since both force and motion are vector quantities, they have directions associated with them. Therefore, an FRF is actually defined between a single input DOF (point & direction), and a single output DOF. FRF is defined as the ratio of the Fourier transform of an output response divided by the Fourier transform of

the input force that caused the output. An FRF is a complex valued function of frequency. Actually FRF measurements are computed in a FFT analyzer

3.7 INTRODUCTION TO ANSYS WORKBENCH

The analysis capabilities of ANSYS include the ability to solve static and dynamic structural analysis, static or time varying magnetic analysis and various types of field and coupled field applications. This program contains many special features, which allow nonlinearities or secondary effects to be include in the solutions, such as plasticity, large strain, hyper elasticity, creep, plasticity, large deflection, contact stress, stiffening, temperature dependency and radiation.

The ANSYS Workbench represents more than a general purpose engineering tool.

- i. It provides a highly integrated engineering simulation platform.
- ii. Supports multi-physics engineering solutions.
- iii. Provides bi-directional parametric associatively with most available CAD systems.

ANSYS represents an application that:

- i. Provides access to a range of ANSYS Engineering Simulation solutions.
- ii. Is designed to handle a limited set of relatively simple engineering solutions.
- iii. Simulation capabilities are limited by the size of engineering and finite element models
- iv. Finite element models are limited to 1000 elements on single parts or assemblies.

Other limitations can be found at it is designed to introduce you to:

- i. The nature and design of the ANSYS Workbench User Interface.
- ii. The concepts of ANSYS Workbench Projects and related engineering simulation capabilities.
- iii. The integrated nature of ANSYS Workbench technology.
- iv. The power of the ANSYS Workbench in using applied parametric modeling and simulation. Techniques to provide quality engineering solutions.

direction of the force is exactly toward the center of the crank radius. In many studies the torsional load is neglected for the load analysis of the crankshaft, and this is because torsional load is less than 10 percent of the bending load. Here torsional load has no effect on the range of Von-Mises stress at the critical location.

IV. PLAN FOR EXPERIMENTAL SET UP

Steps for FINITE ELEMENT ANALYSIS of crankshaft model using ANSYS

The designing software used here is Pro-E. The model of the crankshaft is generated in CAD i.e. Pro-E with different boundary condition.

Procedure for Experimental set up by using FFT analyser

1. First the model of crankshaft is prepared using Pro-e software.
2. The obtained file is saved in .ds format and is given as input file for ANSYS software.
3. The file is opened in window of ANSYS for finite element analysis.
4. For design purpose natural frequency modal is selected mesh setting.
5. Now mesh is obtained.
6. After meshing is over FEA editor is selected.
7. Element type is selected as brick type.
8. Material is chosen as per requirement.
9. Then units are defined in SI.
10. In this required surface of modal is selected and required boundary conditions are given.
11. Now we will click perform analysis button in the toolbar and required modes be shown.

V. PROPOSED EXPERIMENTAL SET UP

- a) In the present work, we will make fast response functions (FRFs) with FFT analyzer, modal excitation techniques and modal parameter.
- b) Experimental modal parameters (Natural frequency, mode shape and amplitude) are obtained from a set of FRF measurements.

Exciting modes with impact testing:-

Impact testing is a fast and low cost way of finding the mode of machines.

The following equipments are required to perform an impact test.

1. An impact hammer use to measure the input force.
2. An accelerometer to measure the response acceleration at a fixed point and direction.

3. FFT analyzer to compute FRFs.

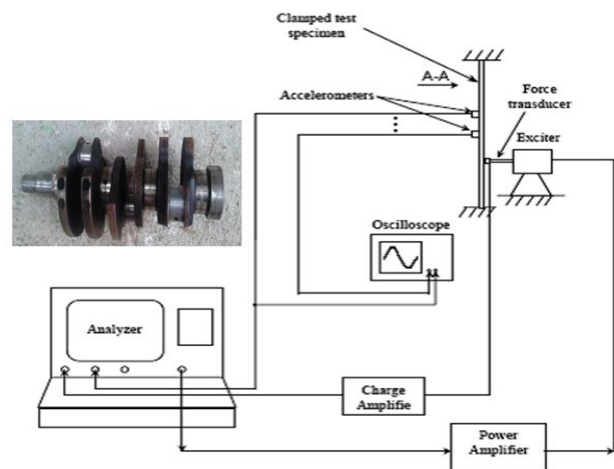

Figure5: Schematic diagram of the experimental set-up

4. Post-processing modal software (ANSYS) for identifying modal parameters and displaying the mode shapes in animation.

Fig.5 shows the schematic diagram of the experimental set-up used for modal testing. The modal characteristic of the crankshaft are obtained by studying its impulse response. Fixture was used to obtain different boundary condition. Vibration exciter is used to excite the specimen. By applying an impact force by the hammer to the crankshaft, the hammer piezoelectric generates a corresponding voltage. The voltage is calibrated to force. Response is measured by an accelerometer which consists of frame, a mass and piezoelectric element. Vibrating the mass in the accelerometer generates the electrical current. The corresponding voltage of is calibrated to acceleration. The signal from the accelerometer and the impact hammer are transferred to computer aided FFT analyser to extract the modal parameters with the aid of ANSYS software.

VI. CONCLUSION

The crankshaft 3D-model was created in Pro-ENGINEER software and then the model created in Pro-Engineer was imported to ANSYS software for analysis.

The differences in natural frequencies obtained from both techniques are very less. Now we can conclude that we can perform the FEA analysis on the same system for more accurate results.

VII. REFERENCES

- [1.] *B D N S Murthy, N S Teja Kollati, "Modelling, Analysis and Optimization of Crankshaft", International Journal of research & Technology, ISSN: 2278-0181, Issue 9, vol.2, (2013),pp.749-753.*
- [2.] *Farzin H. Montazersadgh, "Optimization of a Forged Steel Crankshaft Subject to Dynamic Loading", 'SAE International', Paper No 2008-01-0432, (2007).*
- [3.] *R.B.Sharma & Vikas Sharma, "Dynamic & static analysis of model of engine crankshaft", International Journal of Engineering Research and Applications (IJERA) vol. 3, (2013), pp.631-639.*
- [4.] *Sanjay B Chikalthankar, V.M.Nandedkar, Surender Kumar Kaundal, "Finite Element Analysis approach for stress analysis of crankshaft under dynamic loading", International journal of scientific & engineering research,ISSN 2229-5518.vol 4, Issue 2,(2013),pp.1-5.*

Implementation of Process Capability Study to Improve the Quality of the Piston Manufacturing Process in Batch Production

S. M. Wani¹, A. R. Bang², H. S. Rane³, A. D. Bagul⁴, Dr. V. G. Arajpure⁵

¹ Assistant Professor, Deptt. of Mechanical Engineering

Government College of Engineering, Jalgaon, (MS), India, pin code 425001,

² Head and proprietor,

SOFT-TOUCH CAD/CAM/CAE, Jalgaon, (MS) India, pin code 425001,

³ Assistant Professor, Deptt. of Mechanical Engineering

N. M. K.C., Jalgaon, (MS), India, 425001,

⁴ Assistant Professor, Deptt. of Mechanical Engineering

N. M. K.C., Jalgaon, (MS), India, 425001,

⁵ Principal and Professor, Deptt. of Mechanical Engineering

GF's Godavari C. O.E., Jalgaon, (MS), India, 425003,

¹Email:-gcoe_smw@yahoo.com

Abstract - Quality has turned out to be a standout amongst the most critical shopper choice factors in the determination among contending products and processes. The nature of conformance is the way well the product fits in with the particulars specifications required by the developed design.

The quality can be estimated as far as Process Capability characterized as the index of which the process is equipped for generating mass products with specification limits. Be that as it may, for each item there are sure breaking points for design, manufacturing and use. The farthest point of manufacturing for generating accurate dimensional items may called as specification limits. These limits of confinement mean the end criteria for the batch manufacturing.

The approach introduced here is to characterize the significance of quality and the impact of process capability study on batch manufacturing. The writing accommodated the quality and process capability are valuable to think about the conduct of the manufacturing processes under production. Certain graphical charts have examined here to study the piston manufacturing process.

Keywords - Batch manufacturing, piston, Process Capability, Quality, Specification Limits, etc.

INTRODUCTION

A] Quality of Product-

The quality of conformance is how well the product conforms to the specifications required by the process engineer. Quality of conformance is affected by a

number of variables, including the selection of manufacturing processes, the training and supervision of the worker, the category of process controls, tests, and inspection activities that are applied, the extent to which these processes are followed, and the motivation of the workforce to achieve quality. Unfortunately, this definition has become associated more with the conformance aspect of quality than with development. This is in part due to the lack of formal education most product designers and process engineers receive in quality engineering methodology.

In factories Quality has more definitions and changes from men to men. The overall description about quality is that capability which superior from something in design and manufacturing field. It is also defined as degree of fitness for some purpose. For example, production workers might see quality as conformance to specifications. If the size of the hole they produce is within their tolerance, it is a good hole. If not, it's bad. Marketing people might think of quality as something that sells well and causes little trouble for the customer. Supervisors see quality when production is higher than normal and there are few reworks. Customers see quality if the product does what they expect it to do without any breakdowns.

B] Statistical Quality Control-

Statistical quality control really came into its own during 1942. The need for mass-produced war-related items, such as bomb sights, accurate radar, and other

National Conference on Current Trends in Engineering, Science and Technology (NACCTEST- 2018)
 Organized by GF's Godavari College of Engineering, Jalgaon
International Journal of Innovations in Engineering and Science, Special Conference Issue, 2018
 www.ijies.net

electronic equipment, at the lowest possible cost hastened the use of statistical sampling and quality control charts. Since in World War II these statistical techniques have been refined and sharpened. The use of computers in the last decade has also widened the use of these techniques.

Quality and its management played an important role in human history. Managing quality was required even for ancient civilizations. Standardization was recognized as the first step towards quality. In ancient Rome, a standard measurement system was introduced for manufacturing bricks and pipes; and building regulations were in force. Water clocks and sundials were used in ancient Egypt and Babylon even though they were not terribly accurate. The Chinese Song Dynasty even mandated the control of shape, size, length, and other quality factors of products in handicrafts using measurement tools, such as carpenter's squares.

Considerable measures of factual and systematic strategies are valuable for understanding quality issues and enhancing the execution of procedures i.e. statistical and analytical techniques help to find the quality problems and to improve performances of processes. The role of some of these techniques is illustrated in Fig. 1, which shows a process as a framework of input and outcomes. On account of a production procedure, the controllable inputs information factors x_1, x_2, \dots, x_p are variables of the process, for example, temperatures, weights, feeds rate, and different process factors. Where the z_1, z_2, \dots, z_q are uncertain and uncontrollable wild (or hard to control) inputs, for example, natural variables or properties of crude materials supply by a provider. The production process transforms the input raw materials, component parts, and subassemblies into a finished product that has several quality characteristics. The output variable y is a quality characteristic, that is, a measure of process and product quality.

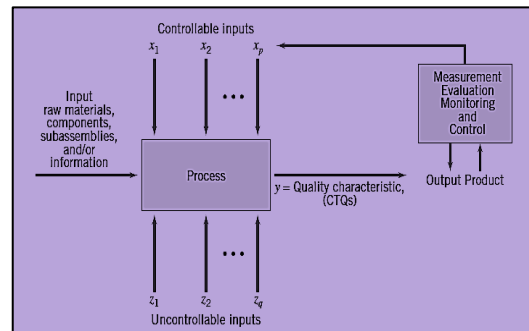

Figure 1 Inputs and Outputs for Manufacturing Process

There has been a tendency to think that Statistical Process Control and Statistical Quality Control are the identical, while the fact is that Statistical Process Control is a calculation of process capability and Statistical Quality Control ensures the quality of product being manufactured. Statistical Process Control is an important part of a successful Statistical Quality Control application. Statistical Process Control assumes that low quality is due to the manufacturing process. So it is the process that must be analyzed to ensure product quality.

Statistical Process Control is the sum total of all technical and managerial skills to control the manufacturing process for developing and maintaining quality. Statistical Process Control techniques have understood that it is possible to improve both quality and productivity simultaneously. Statistical Process Control should not be limited to control charts only, it is also an analytical tool where it tells us, where the problem exists and provides hints on probable causes.

LITERATURE REVIEW

As fast growth of the manufacturing technology, suppliers require their products be high quality with very low fraction of defectives. Traditional methods for measuring fraction of defectives become inapplicable for those high quality processes since any manufacturing sample of reasonable size likely contains no defective product items. [1] Classic techniques such as Statistical Process Control (SPC) and Process Capability Analysis (PCA) that form the Statistical Quality Control can be used to obtain variations or special causes of variability. In the event that the distribution is unknown novel tools such as Functional Data Analysis (FDA), have been used successfully in this communication to study these phenomena in situations where the classic quality control cannot. Control charts and the concept of subgroups can be used successfully in the search and elimination of

National Conference on Current Trends in Engineering, Science and Technology (NACCTEST- 2018)
Organized by GF's Godavari College of Engineering, Jalgaon
International Journal of Innovations in Engineering and Science, Special Conference Issue, 2018
www.ijies.net

variations. When data do not follow a normal distribution, Functional Data Analysis can be used effectively in the detection of variations, also contributing major advantages in the detection of specific variability compared to traditional techniques such as Statistical Control Process. [2] Tuning the quality control strategy appropriately to the characteristics of the process and the characteristics of the quality inspection using discrete event simulation allows more accurate results than just looking at them in isolation. It combines material transport, production, abrasive tool wear, sorting, bulk handling and quality inspection processes. To overcome the limits of a single measurement system a combination of different metrologies will further improve the overall quality inspection reliability. [3]

The application of statistical control charts under auto correlated situations is a critical issue since it has a significant impact on the monitoring capability of manufacturing processes and performance of control charts under different scenarios and to optimize the design of control charts to best deal with auto correlated processes. Statistical process control (SPC) is a methodology used for monitoring and reducing the variation in manufacturing processes and the main tools of SPC are control charts. Normally, SPC works under the assumption that observed data is independent. [4] Statistical process control (SPC) is a powerful technique which organizations can use in pursuit of continuous improvement of both product and service quality. It can be argued that it is not just control charts which makes SPC initiative successful in organizations, rather the emphasis should be on the critical factors which are essential for the success of SPC program and also issues such as "how to get started" and "where to get started". [5] SPC and process capability analysis present powerful means for the analysis of current and previous process behaviour and they provide information that serve as a basis for the process improvement. Correct application of SPC assures possibility to detect special causes of process variation on time, in order to eliminate them before generating defective products. Process capability analysis entails comparing the performance of a process against its specifications, thus enabling analysis of previous and current process performance, as well as benchmarking. This is of special importance when comparing previous or current process performance with the process performance after improvement. [6] Statistics is the art of making decisions about a process

based on an analysis of information obtained from a process. The SPC tool is used to see when a process is working correctly or not. The approach is the improving quality of product through SPC technique. The achievements in the product quality lead to scope of product in the market. [7]

METHODOLOGY

The piston manufacturing process is one of the important manufacturing processes. The piston diameter is affected by various manufacturing parameters like Spindle Speed, Feed and Cutting Depth. Here the piston of an automotive system is considered for analysis purpose. The dimension which is to be measured is piston diameter. The base dimension for piston diameter is 90 mm and the tolerance allowed is ± 0.1 mm. Total 60 numbers of samples in four sub groups are tested and inspected by using standard gauge having Least Count of 0.001 mm. the data can be formulated in excel and converted in array form as shown in Table 1. The data analysis i.e. formation of averages and range for each subgroups has been tabulated as shown in Table 2. Control Chart

The control charts has evolved by Sir Walter Shewhart around 19th century. The basic need of the control charts are to obtain whether the manufacturing process is in control limits or out of control limits. Two main charts are more helpful to inspect the manufacturing process are X-bar chart and R-chart.

The X-bar chart measures the no of parts produced within specification limits. The specification limits are often the Upper and Lower bounds for manufacturing process and required because of variation in process parameters, inspection errors for inspection and properties of materials.

Table 1 Data Collection of Piston Diameter as Measured Parameter

Samples	Sub Group 1	Sub Group 2	Sub Group 3	Sub Group 4
1	90.137	90.112	90.119	90.079
2	90.136	90.003	89.970	90.001
3	89.820	89.937	89.930	89.954
4	90.063	89.887	90.103	89.961
5	90.032	89.996	90.111	90.052
6	90.041	90.073	90.025	89.923

National Conference on Current Trends in Engineering, Science and Technology (NACCTEST- 2018)
 Organized by GF's Godavari College of Engineering, Jalgaon
International Journal of Innovations in Engineering and Science, Special Conference Issue, 2018
 www.ijies.net

7	90.079	89.898	89.932	89.946
8	89.852	89.992	90.092	90.052
9	90.137	89.921	90.024	89.977
10	89.996	89.878	90.056	90.052
11	89.950	89.915	90.029	89.999
12	89.984	89.864	90.063	89.950
13	89.903	89.943	90.021	89.977
14	90.079	90.066	89.936	90.077
15	89.974	89.956	89.970	90.028

Table 2 Data Formulation for Averages and Range

Samples	\bar{X}	Range
1	90.112	0.057
2	90.028	0.166
3	89.910	0.134
4	90.003	0.216
5	90.048	0.114
6	90.016	0.151
7	89.964	0.182
8	89.997	0.241
9	90.015	0.217
10	89.996	0.178
11	89.973	0.114
12	89.965	0.198
13	89.961	0.118
14	90.039	0.144
15	89.982	0.072
AVG	90.001	0.153

These bounds are often called as tolerances. The tolerances are of two types i.e. Upper specification limit (USL) and Lower specification limit (LSL). The dimensions of Piston Diameter should be in between these USL and LSL in order to have proper control on manufacturing process. The figure 2 shows the X-bar chart for data collected from table 1.

The figure 3 shows the R-chart for the collected data. The R-chart measures the range between maximum and minimum of measuring distance. It inspects the variation in the measurement with respect to the control limit (CL). The control is the limit of average of all the ranges of samples.

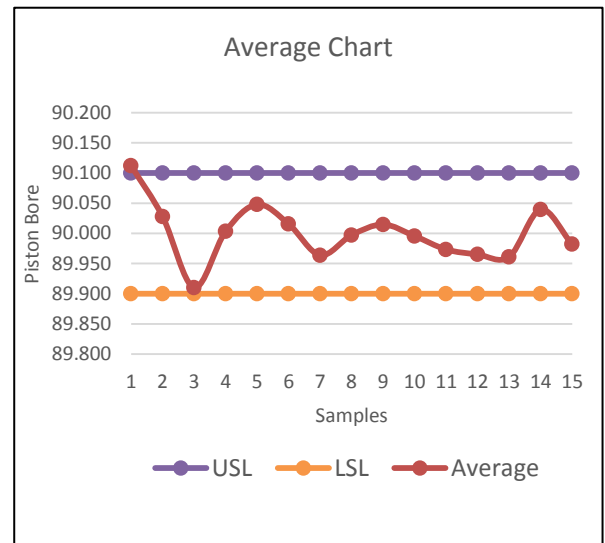

Figure 2 X-bar chart for Collected Data

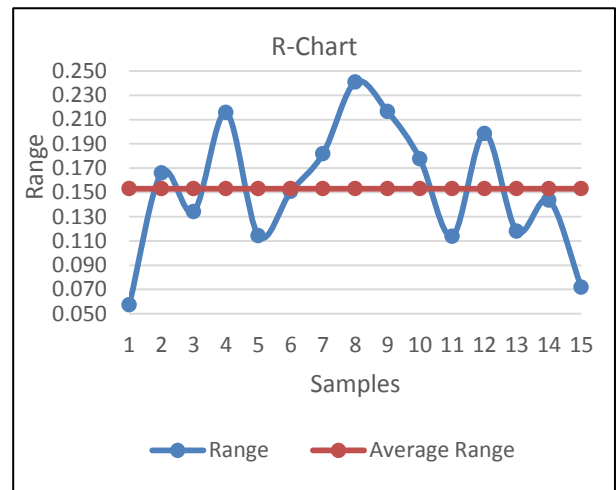

Figure 3 R-chart for Collected Data

CONCLUSION

From this study it is concluded that, manufacturing process affected by various parameters like spindle speed, feed and length of cut. The piston diameter is measured by gauge. The 15 samples of each four sub groups are inspected and used for the statistical process control.

The tools of SPC are more effective and provide better solution to process stability and control. The X-bar chart shows the process is in control and R-chart measures the variation of a sample with mean. The maximum variation leads to the process is out of control. However from R-chart it is concluded that the process

National Conference on Current Trends in Engineering, Science and Technology (NACCTEST- 2018)
Organized by GF's Godavari College of Engineering, Jalgaon
International Journal of Innovations in Engineering and Science, Special Conference Issue, 2018
www.ijies.net

has better performance. The SPC tools could be successfully applied to non-normal data distribution and it could have better results.

Thus, it is concluded that the SPC tools could provide an idea for understanding the variations in manufacturing process and provides statistical remedial actions.

REFERENCES

- [1] W. L. Pearn And Chien-Wei Wu, *An Effective Modern Approach for Measuring High-Tech Product Manufacturing Process Quality*, *Journal of the Chinese Institute of Industrial Engineers*, 22(2), (2005), 119-133.
- [2] J. Sancho, J. J. Pastor, J. Martínez, M. A. Garcia, *Evaluation of Harmonic Variability in Electrical Power Systems through Statistical Control of Quality and Functional Data Analysis*, *Procedia Engineering* 63 (2013), 295-302.
- [3] Daniel Weimer, Daniel Rippel, Torsten Hildebrandt, Michael Lutjen, Bernd Scholz-Reiter, *A strategy for logistic quality control in micro bulk production*, *Procedia Technology* 15, (2014), 323-332.
- [4] Karin Kandananond, *Guidelines for Applying Statistical Quality Control Method to Monitor Auto correlated Processes*, *Procedia Engineering* 69, (2014), 1449-1458.
- [5] Jiju Antony, and Tolga Taner, *A Conceptual Framework for the Effective Implementation of Statistical Process Control*, *Business Process Management*, 9(4), (2003), 473-488.
- [6] Tatjana V. Sibalija and D. Majstorovic, *SPC and Process Capability Analysis– Case Study*, *International Journal of Total Quality Management & Excellence*, 37(1-2),(2009),1-6.
- [7] James Dhinakaran, Maharaja Ganapathy, T. Kodeswaran, Muthu Kannan and Murugun K., *Quality Improvement of Lubricating Oil Pump Shaft Through Statistical Process Control used in Automobile Industries*, *Procedia Engineering*, 38, (2012), 2053-2062.
- [8] WANG Pei, ZHANG Dinghua, LI Shan, Chen Bing, *Machining Error Control by Integrating Multivariate Statistical Process Control and Stream of Variations Methodology*, *Chinese Journal of Aeronautics*, 25, (2012), 937-947.
- [9] Vivtor Kane, *Process Capability Indices*, *Journal of quality Technology*, 18(1), (1986), 41-52.
- [10] Kerstin Vannman, *a Unified Approach to Capability Indices*, *Statistica Sinica*, 5, (1995), 805-820.

National Conference on Current Trends in Engineering, Science and Technology (NACCTEST- 2018)
 Organized by GF's Godavari College of Engineering, Jalgaon
International Journal of Innovations in Engineering and Science, Special Conference Issue, 2018
 www.ijies.net

A Review of Solar water Distillation System with Different Basin Materials and Vacuum

Vishal A. Kale¹, Denin Chalakkal², Aniruddha Y. Chaudhari³

^{1,2} Diploma Student

G.F's Godavari College of Engineering, Second Shift Polytechnic, Jalgaon, India, 425003

³ Assistant Professor

G.F's Godavari College of Engineering, Jalgaon, India, 425003

³Email:- ani_485@rediffmail.com

Abstract – Water is basic need of human being. Due to increase in population and industry there is problem of fresh or pure water. Purification of water is very essential. There are so many devices available in the market for purification of water, but solar still is the most economical method to purify the water as it uses only solar energy which is available on the everywhere and at zero cost. Also the solar still has no moving parts and other filtration member this makes the still maintenance free. An attempt is made in this paper to review about the solar water distillation system, in which the comparisons of basin materials like copper, aluminium, GI are studied for understanding the performance. From the study it shows that copper material of basin has highest productivity of distilled water approximately 5-8 lit/day/m² as compared to aluminium and GI.

Keywords: - solar still, copper, aluminium, GI, vacuum.

INTRODUCTION

Pure water is the basic need of human being. We cannot imagine life without water. The availability of pure water is an important issue in towns. Many people are not satisfied with the water supplied by their municipalities and purchase their own water purifier at home.

The increase in population with the development in industrial leads to pollution of water. The waste water

from the industrial process is drained in the lakes or river in the area which is the main source of water. Pollution. This not only affects the quality of water but also affect the animals living in the water.

Water is an abundant natural re-source that covers three quarters of the earth's surface. However, only about 3% of all water sources is potable. Less than 1% fresh water is within human reach and the rest is ice. Even this small fraction (ground water, lakes and rivers) is believed to be adequate to support life and vegetation on the earth. 30% of all fresh water is under-ground, most of it in deep, hard-to-reach aquifers. Lakes and rivers together contain just a little more than 0.25% of all fresh water; lakes contain most of it. Most of the region in our country depends upon the underground water for drinking. However the underground water contains more salts. The salt concentration varies with the area in the country. The water which contains high salt concentration is called as hard water or brakish water. In such cases, fresh water has to be either transported for long distances or connected with an expensive distribution water network at extremely high cost for a small population. Nowadays pollution in rivers and lakes by industrial effluents and sewage disposal has resulted in scarcity of fresh water in many big towns and cities around the world [1]

Table 1- The IS Specification IS: 10500 for drinking water are given in below table

National Conference on Current Trends in Engineering, Science and Technology (NACCTEST- 2018)
Organized by GF's Godavari College of Engineering, Jalgaon
International Journal of Innovations in Engineering and Science, Special Conference Issue, 2018
www.ijies.net

SI	PARAMETER	LIMIT
1	Color- Hazen units	5
2	Turbidity, NTU	5
3	pH	6.5 to 8
4	Total Hardness as CaCO ₃ -mg/l	300
5	Calcium as Ca -mg/l	75
6	Magnesium as Mg -mg/l	30
7	Copper as Cu -mg/l	0.05
8	Iron as Fe -mg/l	0.3
9	Manganese as Mn -mg/l	0.1
10	Chlorides as Cl -mg/l	250
11	Sulphates as SO ₄ -mg/l	150
12	Nitrates as NO ₃ -mg/l	45
13	Fluoride as F--mg/l	0.6 to 1.2
14	Lead as Pb	0.1
13	Total residual Chlorides -mg/l	0.2
14	Alkalinity, Max	200

In many areas the fossil fuel is used to purify the water. A solar still produce the pure water needed for drinking and cooking. Also distilled water can be used in many industrial processes. It is a simple technology which uses solar energy to purify the water and no special skill is required to operate the still. It uses the solar energy which is available free of cost and due to absence of moving parts its maintenance cost is almost zero and you have invest money only one time. In solar desalination process, the productivity of the solar still is very less in the range of 2 - 5 litres/m²/day only compared to other conventional desalination systems. The problem is to enhance the amount of water produced [2]

Various experiments are carried out to enhance the productivity of solar still in which different modifications are made in conventional still.

SYSTEM RELATED DATA

The amount of water available on the earth is fixed out of which only few can be used for drinking and the remaining water is sea water and in the form of ice. So we can use only ground water and river or lake water for drinking purpose. The demand of water is increasing day by day due to increase in population and increase in industrial area. Hence it is essential to use the sea water for drinking. But due to salt concentration we can't use it directly for drinking. It is necessary to remove salts from the sea water. The process of removing salts from the sea water is known as desalination. The desalination can be done economically and easily with the help of solar still. It uses solar energy to remove salt from water.

WORKING PRINCIPLE

Solar still works on the simple principle of evaporation and condensation. The process of evaporation and condensation takes place inside the still. Water to be desalinated is stored in the basin.

CONSTRUCTION:-

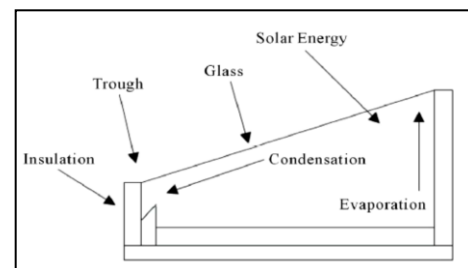

Fig.1-Simple solar still

The solar still is as shown in above fig.1. It consists of box made of plywood for insulation purpose. A basin of metal sheet is placed inside the still. Insulating material like thermo cool or asbestos sheet is kept between the basin and wooden box to eliminate the heat loss. A glass is kept at an inclination which closes the top of still. A trough is provided at the front wall of still to collect the distillate.

WORKING:-

The working of solar still is similar to natural raining process in which the water from the lakes/river/sea gets evaporated by solar energy. These water vapors moves upward and at certain elevation gets

National Conference on Current Trends in Engineering, Science and Technology (NACCTEST- 2018)
 Organized by GF's Godavari College of Engineering, Jalgaon
International Journal of Innovations in Engineering and Science, Special Conference Issue, 2018
 www.ijies.net

condensed and the rain falls. This process is as shown in fig.2

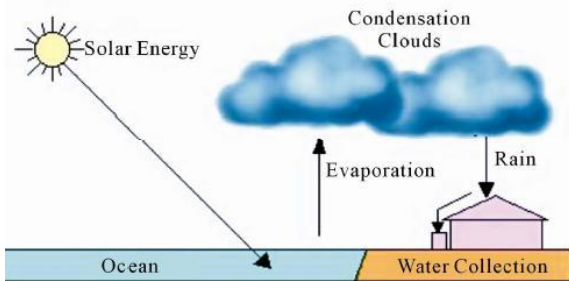

Fig.2 Natural raining process.

The similar principle is used in the solar still. The solar radiations enter the still from the top glass cover. These solar radiations are absorbed by the water kept in the basin, due to this solar energy temperature of water increases and it starts evaporating. The water vapors formed due to evaporation are condensed on the inner wall of the glass cover. The condensed water vapors are then collected through trough as distillate. During this process the solid particles, salts, bacteria remain in the basin and only fresh water is collected. Thus we get the pure water from the dirty or salty water.

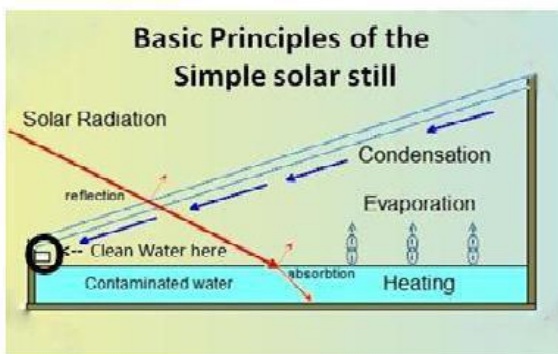

Fig.3 working of solar still.

MATHEMATICAL MODEL

In solar distillation systems, heat transfer can be classified in to two types, internal heat transfer and external heat transfer. The external type heat transfer is due to conduction, convection and radiation processes. The heat transfer takes place within the solar still is called internal heat transfer which is mainly due to convection, radiation and evaporation. Performance of a solar still is directly depends on the internal heat transfer

and fresh water production rate. Density difference of humid air due to temperature difference inside the solar still is the major reason for convective heat transfer. Relation for convective heat transfer coefficient (h_{cw}) from water to glass cover is, [5]

$$h_{cw} = 0.884 \left[(T_w - T_g) + \frac{(P_w - P_g)(T_w + 273)}{268.9 \times 10^3 - P_w} \right]^{1/3}$$

where,

$$P_w = \exp\left(25.317 - \frac{5144}{T_w + 273}\right)$$

$$P_g = \exp\left(25.317 - \frac{5144}{T_g + 273}\right)$$

Where

- P_w - partial vapor pressure at water temperature
- P_g - partial vapor pressure at glass temperature
- T_w – Water temperature
- T_g – Glass Temperature

The evaporative heat transfer coefficient (h_{ew}) from water to glass cover is given by.

$$h_{ew} = 16.27 \times 10^{-3} \times h_{cw} \times \frac{(P_w - P_g)}{(T_w - T_g)}$$

Where,

- T_w - water temperature in °C
- T_g - Glass temperature in °C

The radiation heat transfer coefficient (h_{rw}) from water to glass is given by

$$h_{rw} = \epsilon_{eff} \sigma [(T_w + 273)^2 + (T_g + 273)^2] / (T_w + T_g + 546)$$

Where,

$$\sigma = 5.669 \times 10^{-8} \text{ W/m}^2 \text{ K}^4$$

$$\epsilon_{eff} = \left(\frac{1}{\epsilon_g} + \frac{1}{\epsilon_w} - 1 \right)^{-1}$$

$$\epsilon_g = \epsilon_w = 0.9$$

Total heat transfer coefficient (h_{total}) from water to glass is given by

National Conference on Current Trends in Engineering, Science and Technology (NACCTEST- 2018)
Organized by GF's Godavari College of Engineering, Jalgaon
International Journal of Innovations in Engineering and Science, Special Conference Issue, 2018
www.ijies.net

$$h_{total} = h_{cw} + h_{ew} + h_{rw}$$

Hourly yield of solar still is given by.

$$m_w = \frac{q_{ew} A_w}{L} \times 3600$$

Where,

- mw- mass of water evaporated(kg)
- qew- evaporative heat transfer from water to glass (W/ m2)
- Aw- area of water(m2)
- L- Latent heat of evaporation

Using above formulae the theoretical output of the solar still can be calculated.

LITERATURE REVIEW

In solar desalination process, the productivity of the solar still is very less in the range of 2 - 5 litres/m2/day only compared to other conventional desalination systems. The problem is to enhance the amount of water produced [2]. Various experiments are carried out to enhance the productivity of solar still in which different modifications are made in conventional still.

Moses Koilraj Gnanadason, Palanisamy Senthil Kumar, Gopal Sivaraman, Joseph Ebenezer Samuel Daniel carried out an experiment on solar still with copper basin and providing vacuum inside the still. We know that when the pressure is reduced water starts evaporating at low temperature. At 20 kPa pressure water starts evaporating at 60°C. So we need to operate the vacuum pump to reduce the pressure to this value and then leave it in the sun for distillation. This will ensure boiling of water inside the distiller as soon as the temperature reaches 60°C, which is pretty low and easily achievable by using simple designs. In the design they used a simple vacuum pump to reduce pressure inside the distillation chamber which will be operated intermittently to maintain the vacuum constantly. Copper has higher thermal conductivity of 395 W/mK comparatively higher than Iron, hence the rate of heat transfer to water in the still is more. Due to this modification in vacuum still the evaporation rate increases and hence the yield increase to 8 litres/day/m2 [1]

S. Nanda kumar, .P.Shantharaman made an experiment on solar still with basin coated with white and black paint on inner surface and found that the solar still with black coating has higher productivity than the basin with white coating [2]

Hitesh N Panchal and P. K. Shah made three solar stills to study and compare the performance of the solar stills. The first one is a solar still having Aluminum Plate and the second is solar still having Galvanized iron plate while the third is a conventional solar still. The conventional still (a single basin) has a basin area of 1 m2 (50 cm×200 cm). The still is made of iron sheets (2.5 mm thick). The whole basin surfaces are coated with black paint from inside to increase the absorptivity. Also, the still is insulated from the bottom to the sidewalls with sawdust 5 cm thick to reduce the heat loss from the still to atmosphere. The insulation layer is supported by a wooden frame. The basin is covered with a glass sheet 3 mm thick inclined at nearly 30° horizontally. They found that cumulative distillate output of solar still having aluminum plate is higher compared with conventional solar still and Solar still having Galvanized Iron plate. 45 % more output achieved by Solar still having Aluminum plate and 15 % more output achieved by solar still having Galvanized iron plate [3]

A.Balavignesh, D.B.Sivakumar put the mirrors on the inner side walls of still and found that by using the reflecting sides there is increase in water temperature from 56°C to 62°C and the percentage increase of distillate productivity up to 26.37%. [4]

With the help of Computational Fluid Dynamics (CFD) method the condensation and evaporation process in solar still is developed for simulation. Simulation result is compared with actual experimental data of solar still. The simulation results for productivity, water temperature and heat transfer coefficients are nearly same. Study shows that CFD is a powerful tool for the performance analysis of single slope solar still. [5]

CONCLUSION

From the above discussion it is clear that the solar still having copper plate for basin has highest productivity. However the productivity can be further increased by applying black coating on inner surface of basin and providing vacuum inside the still i.e. by lowering the pressure we can evaporate the water at low temperature.

National Conference on Current Trends in Engineering, Science and Technology (NACCTEST- 2018)
Organized by GF's Godavari College of Engineering, Jalgaon
International Journal of Innovations in Engineering and Science, Special Conference Issue, 2018
www.ijies.net

Also by using reflecting materials on the inner wall of the still we can get the higher water temperature.

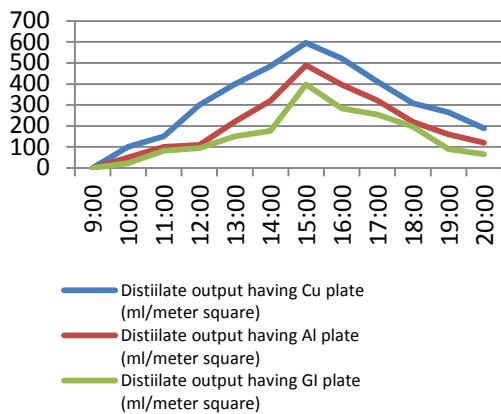

REFERENCES

- [1] Moses Koilraj Gnanadason, Palanisamy Senthil Kumar, Gopal Sivaraman, Joseph Ebenezer Samuel Daniel, " Design and Performance Analysis of a Modified Vacuum Single Basin Solar Still", *Smart Grid and Renewable Energy*, 2011, 2, 388-395, doi:10.4236/sgre.2011.24044
- [2] S. Nanda kumar, .P.Shantharaman " Fabrication of solar water distillation system", *International Journal Of Core Engineering & Management (IJCEM)*, Volume 2, Issue 1, April 2015,pp 179-186.
- [3] Hitesh N Panchal and P. K. Shah, " Performance Analysis of Solar Still Having Different Plates", *International Journal of Energy Science IJES Vol.2 No.1 2012 PP.26-29*
- [4] A.Balavignesh, D.B.Sivakumar, " Investigation On The Single Slope Solar Still With Reflecting Materials", *International Conference on Energy Efficient Technologies For Automobiles (EETA' 15)*, JCHPS Special Issue 6: March 2015,pp 170-172.
- [5] Regil Badusha and T V Arjunan, " Performance Analysis Of Single Slope Solar Still", *IJMERR*, Vol. 2, No. 4, October 2013,pp 74-81
- [6] Juan Cristóbal Torchia-Núñez, Jaime Cervantes-de-Gortari, Miguel Angel Porta-Gándara, " Thermodynamics of a Shallow Solar Still", *Energy and Power Engineering*, 2014, 6, 246-265
- [7] Amos Madhlopa, " Development of an advanced passive solar still with separate condenser", 2009.
- [8] Sathish Kumar T R, Raja Bharathi B, " Effect of Water Depth on Productivity of Solar Still with Thermal Energy Storage", *International Journal of Science and Research (IJSR)*, Volume 2 Issue 3, March 2013,pp 413-417

National Conference on Current Trends in Engineering, Science and Technology (NACCTEST- 2018)
 Organized by GF's Godavari College of Engineering, Jalgaon
International Journal of Innovations in Engineering and Science, Special Conference Issue, 2018
 www.ijies.net

A Review Paper on Chairless Chair

Mr.Jagtap Vinayak¹ Mr.Vyas Mahesh² Mr. Mahajan Chetan³ Mr. Soni Vijay⁴ Mr. Bonde Pankaj⁵, Prof. Talha Ahmed⁶.

^{1,2,3,4,5}Students

GF's Godavari College Of Engineering ,Jalgaon ,India , 425001

Assistant Professor⁶

GF's Godavari College Of Engineering ,Jalgaon ,India , 425001

²Email:- mahesh.vyas20495@gmail.com

Abstract – It's an innovative and forward-thinking concept, the ability to sit anywhere and everywhere with the aid of a chairless chair. It's like a chair that isn't there, but magically appears whenever you need it. It's called the chairless chair and you wear it on your legs like exoskeleton, when it's not activated, you can walk normally or even run. Like a chair that is now there.

Standing for hours or end causes a lot of distress to lower limbs, but most works get very few breaks and chairs are rarely provided, because they take up too much space. So the best idea was to strap an unobtrusive chair directly to yourself. So it was decided to have this innovative concept in reality, to help workers who work for hours on production line in standing position and tired

.Keywords- Chairless Chair, Exoskeleton, Ergonomics

INTRODUCTION

It's an innovative and forward-thinking concept the ability to sit anywhere and every-where with the aid of a chairless chair. The concept was first conceived two years ago by Keith Gunura, co-founder and CEO of noonee, and since then the company has de-veloped its Chairless Chair and entered talks with a number of leading manufacturers. Designed for static and dynamic industrial market applications, the Chairless Chair aims to increase user's health, comfort, and productivity. It's like a chair that isn't there, but magically appears whenever you need it. It's called the Chairless Chair and you wear it on your legs like an exoskeleton: when it's not activated, you can walk normally or even run. Like a chair that is now there. Standing for hours on end causes a lot of distress to lower limbs, but most workers get

very few breaks and chairs are rarely provided, because they take up too much space. So we thought that the best idea was to strap an unobtrusive chair directly to you.

The device never touches the ground, which makes it easier to wear, a belt secures it to the hips and it has straps that wrap around the thighs. A variable damper engages and supports the bodyweight, which is directed towards the heels of the shoes. These are specially designed and part of the mechanism, but an alternate version works with any footwear and touches the ground only when in a stationary position. The 'chairless chair', which Audi has further developed together with a Swiss start up company, is an exoskeleton that is worn on the back of the legs. It is fastened with belts to the hips, knees and ankles. Two leather covered surfaces support the buttocks and thighs while two struts made of carbon fiber reinforced plastic (CFRP) adapt to the contours of the leg..

LITERATURE REVIEW

The Chairless Chair then locks into that configuration, directing their weight down to the heels of their shoes, to which it is attached it also attaches to the thighs via straps, and to the waist using a belt. There are as many different types of chairs as there are types of people. It is an object that is available to most everyone. In its different embodiments it can be humble or regal, made of traditional wood or high-tech polymers, simple in concept or highly charged with meaning. Fundamentally, the requirements for a chair are few. It is essentially a horizontal surface at a logical distance from the ground meant to support the human body while sitting. A vertical surface is provided for back support.

National Conference on Current Trends in Engineering, Science and Technology (NACCTEST- 2018)
Organized by GF's Godavari College of Engineering, Jalgaon
International Journal of Innovations in Engineering and Science, Special Conference Issue, 2018
www.ijies.net



Fig. Shoe Link

C. Stopper

It is the most important part of our project. This Part gives stability to whole project. It is made up of mild steel.



Fig 3.3 Stopper

D. Tie Belt

Belt is used for strapping of exoskeleton to human body. Belt will be taken as standard material available in market to wrap the model as waist and thigh.

E. Software

The computer system consists of the software. The software used for plotting is "CATIA Software And Software".

CONCLUSION

In this paper on design and fabrication of chairless chair has been done. The main goal of our paper was to give the comfort to workers, who work on production line for hours. Also to make the model at least cost, that has been achieved. The work started with designing of model and

procurement of required material. ANSYS Software used for analysis. Finally fabricated Chairless Chair at workshop. The model is working satisfactorily. This concept was new and the data available was also limited. There are some future modifications possible.

ACKNOWLEDGMENT

I has been sincere desire of every individual to get an opportunity to express his views, skills, attitude and talent in which his proficient to give his satisfaction and confidence in his ability to do or produce something useful for humankind. A project is one such avenue through which an engineer gives vent to his feeling and expressions.

We wish to thank our **guide PROF. TALAH AHMED** (lecturer of mechanical dept.) for his valuable suggestion and inspiring guidance. We are thankful to honorable **Principal DR. V.G.ARAJPURE** for their precious time whenever we wanted any help from them. They are also helpful in giving professional ideas and technical references. We also express deepest thanks to **HOD of mechanical dept. Dr. V H Patil** & staff members concerned who have meticulous planning created a comfortable co-existence of this paper and college schedule.

Last but not least we are also thankful to our friends who gave us their help and great co-operation to make our project successful directly and indirectly.

REFERENCES

- [1] Nancy Owano , "Chairless Chair Solution Offered as Leg Exoskeleton for Work", *Tech Xplore* 22 August 2014.
- [2] Emin Kahya , "The Effects of Job Characteristics and Working Conditions on Job performance", *Department of Industrial Engineering, Eskisehir Osmangazi University, Turkey, Received 26 September 2006.*
- [3] Paul Buckley , " Work related musculoskeletal disorders " *Statistics, Great Britain, 2015.*
- [4] Banbury , "Health and Safety Policy - Part 4 Mechanical Equipment ", *Produced by the Health and Safety Department, the University of Edinburgh. Aug 2010.*
- [5] Caroline Kelly, "The Beauty of Fit: Proportion and Anthropometry in Chair De-sign", *Georgia Institute of Technology, April 2005.*

National Conference on Current Trends in Engineering, Science and Technology (NACCTEST- 2018)
Organized by GF's Godavari College of Engineering, Jalgaon
International Journal of Innovations in Engineering and Science, Special Conference Issue, 2018
www.ijies.net

- [6] *Scott Openshaw et al ,“ Ergonomics and Design A Reference Guide”, Marcus Ford c 2006 Allsteel In.*
- [7] *Martin Helander, “Guide To Human Factors And Ergonomics” Second Edition , Nanyang Technological University Singapore, Taylor & Francis Group*
- [8] *.Boca Ra-ton London , New York..*

National Conference on Current Trends in Engineering, Science and Technology (NACCTEST- 2018)
 Organized by GF's Godavari College of Engineering, Jalgaon
International Journal of Innovations in Engineering and Science, Special Conference Issue, 2018
 www.ijies.net

A Review on Automatic Tyre Inflation System

Patil Tejas Sanjay¹, Patil Dhanraj Gulabrao², Nikum Mayur Chandrakant³,

Pawar Rohit Shamkant⁴, Pingale Mayur Suresh⁵, Dr. V H Patil⁶

^{1,2,3,4,5}B.E. Student

GF'S Godavari College Of Engineering Jalgaon, India 425003

⁶ Head of Department of Mechanical Engineering

GF'S Godavari College Of Engineering Jalgaon, India 425003

¹Email:- tejas6753@gmail.com

Abstract – Driven by studies that show a drop in tyre pressure by just a few PSI can result in the reduction of gas mileage, tire life, safety and vehicle performance, we have developed an automatic, self-inflating tire system that ensures that tyre are properly inflated at all times. Our design proposes and successfully implements the use properly compressor that will supply air to all four tyre via hoses and a rotary joints fixed between the wheel spindle and wheel hub at each wheel. The rotary joints effectively allow air to be channeled to the tyres without the tangling of hoses. With the recent oil price hikes and growing concern of environmental issues, this system a potential improvement in gas mileage; tyre wear reduction; and an increase in handling and tyre performance in diverse conditions.

Keywords- *Automatic Tyre Inflation System, Manual Tyre Inflation System etc.*

INTRODUCTION

The “Automatic tyre inflation system” is a Mechanical device which is widely used in automobile works. The manual work increases the effort of the man power (operator) during the air checking in vehicles. The

Air Maintenance Technology system developed through this project replenishes lost air and maintains optimal

tire cavity pressure whenever the tire is rolling in service, thus improving overall fuel economy by reducing the tire's rolling resistance. Automation can be

achieved through computers, hydraulics, pneumatics, robotics, etc., of these sources, pneumatics form an attractive medium for low cost automation.

Today automobile sector plays a big role in the economics of all the countries in the world and lots of researches have been carried out to improve the efficiency of the vehicle one the techniques to improve the efficiency of an automobile is inflate the tyre regularly. As its well-known, one of the most serious problem that the large motor vehicle have whether they are for the transportation of passenger or cargo and especially those used for middle or longer distance travel, resides the ensuring the correct performance of the tyres. This means making sure that tyre are inflated and stay inflated for the right amount of pressure for the load being carried and for road condition this way one can ensure not only the preservation of outer covering of the tyres, but also the correct operation of vehicle without any risks.

National Conference on Current Trends in Engineering, Science and Technology (NACCTEST- 2018)
Organized by GF's Godavari College of Engineering, Jalgaon
International Journal of Innovations in Engineering and Science, Special Conference Issue, 2018
www.ijies.net

The deflation is a process of letting air or gas out of the tyres. Deflation is the problem of an automobile vehicle. Because a certain period of time in air reduced to the vehicle for running time. So a long distance travelled vehicle scarable things for deflation.

LITERATURE SURVEY

A tyre is a ring-shaped covering that fits around a wheel's rim to protect it and enable better vehicle performance. Most tires, such as those for automobiles and bicycles, provide traction between the vehicle and the road while providing a flexible cushion that absorbs shock. The earliest tires were bands of iron placed on wooden wheels, used on carts and wagons. The tire would be heated in a forge fire, placed over the wheel and quenched, causing the metal to contract and fit tightly on the wheel. A skilled worker, known as a wheel Wright, carried out this work. The outer ring served to "tie" the wheel segments together for use, providing also a wear-resistant surface to the perimeter of the wheel. The word "tire" thus emerged as a variant spelling to refer to the metal bands used to tie wheels. The first practical pneumatic tire was made by Scottish inventor John Boyd Dunlop while working as a veterinarian in May Street, Belfast in 1887 for his son's bicycle, in an effort to prevent the headaches his son had while riding on rough roads. S. Dunlop is credited with "realizing rubber could withstand the wear and tear of being a tire while retaining its resilience".

SURVEY ANALYSIS

We administered a 15 question survey to potential users for this dynamically self-inflating tire system to gain an understanding of their knowledge regarding the topic as well as to observe their preferences for certain aspects that we can incorporate with our system. Below is a list of the main points discovered from our results:

- Only 4.3% of those surveyed check their tire pressures on a weekly basis.
- Only 5.3% of survey participants check their tire pressures for fuel economy.
- Most participants check their tire pressures for safety reasons instead of tire wear.
- Those that do not check their tire pressures either do not care or do not know the correct pressures.

- Roughly half of those surveyed have had their tires replaced in the 3-4 year timeframe.
- Almost half of those surveyed never check their tire tread depth.
- Those that do check their tread depths mostly check it for safety concerns.
- Those that never check their tread depths either do not know the correct depth or do not care.
- 70% of those surveyed drive on the highway a moderate amount (50% of all driving done on highways).
- 48% of survey participants drive over the legal speed limit.
- 52% of those surveyed drive compact cars and the rest sports cars, trucks/SUVs, and mid size cars.
- 66% care about vehicle appearance.
- 86% of survey participants listen to music/radio at a moderate to loud volume level.
- Almost half of those surveyed get their vehicle service every 6 months and are mostly willing to wait either 1 hour or 1 day depending on the type of service required.
- 70% of survey participants would look to purchase a middle grade vehicle.

WORKING:

Our project consists of solenoid valve, control unit, pressure sensor and Tyre model. We are using pressure sensor to detect the pressure level in the Tyre. The level of pressure is already programmed in the control unit. When the pressure level is decreased, the sensor gives signal to the control unit. After that the controller unit will open the solenoid valve for filling the air when the required pressure is obtained the control unit will turn OFF the solenoid valve. In case the pressure level will be more than the required level means control unit will switch ON another solenoid valve for air to the atmosphere. When the required pressure is reached the operation will be stopped by the control unit.

National Conference on Current Trends in Engineering, Science and Technology (NACCTEST- 2018)
 Organized by GF's Godavari College of Engineering, Jalgaon
International Journal of Innovations in Engineering and Science, Special Conference Issue, 2018
 www.ijies.net

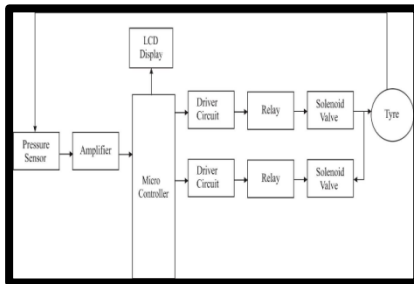

Fig. Block diagram of working system

ADVANTAGES:

- The dynamically-self-inflating tyre system would be capable of succeeding as a new product in the automotive supplier industry. It specifically addresses the needs of the consumers by maintaining appropriate tire pressure conditions for:
 - Reduced tyre wear
 - Increased fuel economy
 - Increased overall vehicle safety
- Providing sufficient airflow to the tire with minimal leakage.
- Withstanding the static and dynamic loading exerted on the rotary joints Note that likewise, this system would not produce any negative dynamic effects (such as CV joint failure due to resonance) on surrounding systems. Most significantly, the self-inflating tire system would be a successful product because of its economic benefits to investors.
- Pressure adjustment based on increasing vehicle speed
- Pressure adjustment based on increasing vehicle load
- Adaptability for recreational use (inflating rafts, sports balls, etc.).
- Implementation of interactive display.
- Creation of universal design for aftermarket use.

DISADVANTAGES:

- However, not everyone will benefit from this technology.
- Both tire manufacturers and the petroleum industry will be negatively affected by this resulting design.

- Tire manufacturers will be negatively affected since this product is being designed with the reduction of tire wear in mind.

The demand for their products will decrease as tires last longer and fewer replacements are needed.

CONCLUSION

The project carried out by us made an impressive task in the field of automobile field. This project will reduce the cost involved in the concern. Project has been designed to perform the entire requirement task at the shortest time available. In this project is used to all the automobile vehicles. Now the project is designed to the ideal condition vehicles. Then our project developed to the next level of running condition vehicle. Because of their vehicles will be a running condition some times to puncturing the tyre. So the alternative sensors are used to their process. Then the air will be filled in the tyre pressure per the seconds. They calculate and the air filling efficiency and to find out the punctured tyres. So easily identified the punctured and to solve the problems. In this process is an advanced technique of our project.

REFERENCES

- [1] H. Song, J. Colburn, H. Hsu, and R. Wiese. *Development of reduced order model for modelling performance of tire pressure monitoring system*. In *IEEE 64th Vehicular Technology Conference*, pages 1.5, 2006.
- [2] NHTSA, *Federal Motor Vehicle Safety Standards [Online]*.
- [3] Song, H.J.; Colburn, J.S.; Hsu, H.P.; Wiese, R.W.; "Development of Reduced Order Model for Modeling Performance of Tire Pressure Monitoring System", *IEEE 64th Vehicular Technology Conference, 2006. VTC-2006 Fall. 2006*, Page(s): 1 – 5.
- [4] Velupillai, S.; Guvenc, L.; "Tire Pressure Monitoring [Applications of Control]", *IEEE Control Systems 2007, Volume: 27, Issue: 6, Page(s): 22 – 25*.
- [5] V.Jeeva Bharathi1 , D.Johny2 , G.Kabilan3 , K.Karthik4 , M.Mohanraj5 "DESIGN AND FABRICATION OF AUTOMATIC TYRE INFLATION AND DEFLATION SYSTEM", *Vol-2 Issue-3 2016, IJARIE-ISSN(O)-2395-4396*
- [6] Obringer, Lee Ann. "How Self-Inflating Tires Work." *Howstuffworks.com*. Retrieved September 30, 2006

National Conference on Current Trends in Engineering, Science and Technology (NACCTEST- 2018)
Organized by GF's Godavari College of Engineering, Jalgaon
International Journal of Innovations in Engineering and Science, Special Conference Issue, 2018
www.ijies.net

A Review on Manufacturing of Cooling Tower

Mr. Aakash Shinde¹, Mr. Danish Khan², Mr. Pawan Deore³, Mr. Kunal Sonawane⁴, Mr. Rehan Shaikh⁵, Dr. V. H. Patil⁶

^{1,2,3,4,5}Students

GF's Godavari College Of Engineering, Jalgaon, India, 425001

⁶Associate Professor

GF's Godavari College Of Engineering, Jalgaon, India, 425001

¹Email:- aakashshinde299@gmail.com

Abstract – Study on the performance of the cooling tower in steam power plant by using Cussons technology steam plant to conduct on experiment and analyze the effect of flow rate control and water make up control to the cooling tower. This simply investigated the flow floe rate of water from cooling tower effect the condensate time, the condensate flow rate and the efficiency of steam turbine by using three different flow rate of cooling tower for 12,000 L/hr 10,000 L/hr and 8,000 L/hr. Then it is separated for two types , one is for two nozzles fully open and other is three nozzle fully open. Comparison between them is performing in the analysis. An was made for analyzing the effect of tower make-up control to performance of cooling tower but due to technical problems there are no data taken regarding the make-up water.

Keywords- Cooling tower, Flow rate control, Nozzles, performance.

INTRODUCTION

In comparison with most other industrial equipments, the water cooling tower is a simple device, based on the direct contact of two of the earth's most common substances: air and water; yet a surprising number of misconceptions on its design, operation and behavior prevail. Cooling basics and important misconceptions are discussed herein, with the goal of helping to achieve the most economical and beneficial application, design, and operation of this important heat transfer device to the maximum extent.

LITERATURE REVIEW

This paper has the research from other people regarding the performance of cooling tower. The explanation of types, and the theory involving cooling tower are described thoroughly as the cooling tower used in industry. Without cooling tower, big facility or building temperature might not stable at it will increased the heat to the people in the building. There are also some explanation about the system and the theory on heat transfer between air and water in the cooling tower.

- S.V. Bedekar, P.Nithiarasu and K.N. Seetheramu have studied the performance of fluidized-bed cooling tower: ignoring the higher pressure drop compare to other film and flash type tower, there performance was excellent. Sisupalan and Seetharamu examined the performance variation of a fluidized-bed cooling tower for different static bed heights.
- Al-Waked and Masud Behenia made research about computational fluid Rafat dynamics (CFD) simulation of bed cooling tower. Heat and mass transfer inside a natural draft wet cooling tower (NDWCT) have been investigated numerically under different operating and crosswind conditions.
- J.C. Kloppers and D.G. Kronger has studied the influence of temperature inversions on wet cooling tower performance. Normal temperature inversion has detrimental effect on the performance of natural draught wet cooling towers. The effect of temperature

National Conference on Current Trends in Engineering, Science and Technology (NACCTEST- 2018)
Organized by GF's Godavari College of Engineering, Jalgaon
International Journal of Innovations in Engineering and Science, Special Conference Issue, 2018
www.ijies.net

METHODOLOGY

The basic function of a cooling tower is to cool water by intimately mixing it with air. This cooling is accomplished by a combination of Sensible heat transfer between the air and the water (Conduction and Convection) and it controlled by temperature differences and area of the contact between air and water and the evaporation of a small portion of the water. In the cooling towers, the evaporation is the most effective part in the cooling process. The basic function of cooling tower is that of evaporative condensation and exchange of sensible heat. The air and water mixture releases latent heat of vaporization which has a cooling effect on water by turning a certain amount of liquid into its gaseous state thereby releasing the latent heat of vaporization, following are general terminology of cooling tower,

Windage or Drift

Water droplets that are carry out of the cooling tower with the exhaust air. Drift droplets have the same concentration of the impurities as the water entering the tower. Drift can also reduce by using warmer entering cooling tower temperature.

Blowout

Water droplets blown out of the cooling tower by wind, generally at air inlet openings. Water may also be lost, in the absence of wind, through splashing or misting.

Plume

The steam of saturated exhaust air leaving the cooling tower. The plume is visible when vapour it contains condenses in contact with cooler ambient like the saturated air in one's breath fog on cold day.

Drawn or Blow-down

The portion of the circulating water flow that is removed (usually discharged to drain) in order to maintain the amount of Total Dissolved Solids (TDS) and other impurities.

Make-up

The water that must be added to the circulating water system in order to compensate water losses such as evaporation, drift loss, blow-out, blow-down, etc.

Noise

Sound energy emitted by a cooling tower and heard (recorded) at a given direction. Motors, gearbox or drive belts

WORKING PRINCIPLE

The basic principle of the cooling tower operation is that of evaporative condensation and exchange of sensible heat. The air and water mixture releases latent heat of vaporization on which has a cooling effect on water by turning a certain amount of liquid into its gaseous state thereby releasing the latent heat of vaporization. This is more effectively demonstrated by wetting the back of your hand with water and blowing on it. There are many sub-joints like t-joint, elbow, long pipes and many other. The working cycle of cooling tower is depends on its simple variable, and vividly indicates cooling tower capability.

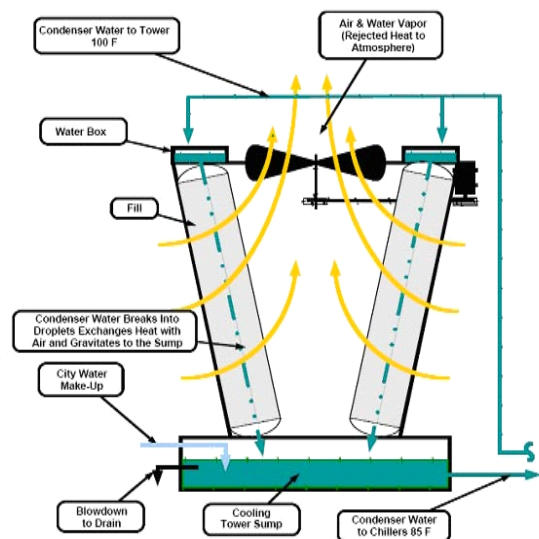

Fig 1:- Working Principle of cooling tower

The basic principle of the cooling tower operation is that of evaporative and exchange of sensible heat. The air and water mixture releases latent heat of vaporization which has a cooling effect on water by turning a certain amount of liquid into its gaseous state thereby releasing the latent heat of vaporization.

When water is warmer than the air, there is a tendency for

National Conference on Current Trends in Engineering, Science and Technology (NACCTEST- 2018)
Organized by GF's Godavari College of Engineering, Jalgaon
International Journal of Innovations in Engineering and Science, Special Conference Issue, 2018
www.ijies.net

the air to cool the water. The air then gets hotter as it gains the sensible heat of the water and the water is cooled as its sensible heat is transferred to the air. Approximately 25% of the sensible heat transfer occurs in the tower while the balance of the 75% cooling is due to the evaporative effect of latent heat of vaporization.

IMPLEMENTATION

The basic principle of the cooling tower operation is that of evaporative condensation and exchange of sensible heat. The air and water mixture releases latent heat of vaporization which has a cooling effect on water by turning a certain amount of liquid into its gaseous state thereby releasing the latent heat of vaporization. This is more effectively demonstrated by wetting the back of your hand with water and blowing on it

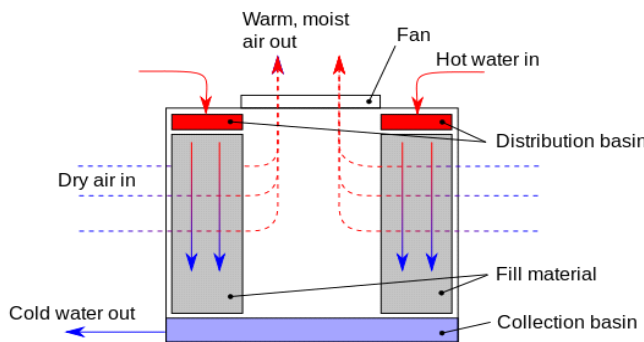

Fig 2:- Implementing of cooling tower by counter flow

Industrial cooling towers can be used to remove heat from various sources such as machinery or heated process material. The primary use of large, industrial cooling towers is to remove the heat absorbed in the circulating cooling water systems used in power plants, petroleum refineries. The most common misconception concerning evaporation is that competing tower manufacturers and designs can accomplish widespread differences in the amount of water being evaporated in a cooling tower. The truth of the matter is that the large majority of heat exchange in a cooling tower is accomplished by the evaporation of a portion of the circulating water. This removes heat from the remainder of the circulating water by removing the latent heat of vaporization necessary to accomplish this phase change. Inasmuch as evaporating water is the basic function of the cooling tower, one is misled to believe that a cooling tower can operate successfully without the proper evaporation. There are a few design features that can have a minor effect on the evaporation rate. For example, cooling towers with identical duties, but operating at different L/G ratios, will have slight

ly different evaporation rates. The normal "rule of thumb" for determination of evaporation the circulating water flow.

ACKNOWLEDGEMENT

We would like to acknowledge all the people who have been of the help and assisted me throughout my project work.

First of all we would like to thank my respected guide **Dr. V.H. Patil** in Department of Mechanical Engineering for introducing me throughout features needed. The time-to-time guidance, encouragement, and valuable suggestions received from him are unforgettable in our life. This work would not have been possible without the enthusiastic response, insight, and new ideas from him.

We would like to thank my lovely parents for time-to-time support and encouragement and valuable suggestions, for the emotional as well as strong support each and every time also for continued loving care and emotional support at every stage of this paper.

The acknowledgement would be incomplete without mention of the blessing of the Almighty, which helped me in keeping high moral during most difficult period

AVANTAGES

- i. It can achieve the water temperature below the air temperature used to cool it.
- ii. It smaller and cheaper for the same cooling load.
- iii. As this is a conventional methodology of cooling the air it gives a Delta 'T' for temp around 4 to 5°C.
- iv. Low cost solution.
- v. Can be very much adapted by industry.
- vi. Low maintenance.

CONCLUSION

In this project we have studied that hot water temperature decreases five degree to ten degree centigrade in five minutes of interval. A model for the optimal detailed design of cooling towers has been presented. The physical properties and the transport phenomena parameters are rigorously modeled for a

National Conference on Current Trends in Engineering, Science and Technology (NACCTEST- 2018)
Organized by GF's Godavari College of Engineering, Jalgaon
International Journal of Innovations in Engineering and Science, Special Conference Issue, 2018
www.ijies.net

proper prediction. The objective function consists of the minimization of the total annual cost, which considers operating and capital costs. Results show that low wet temperatures for the air inlet and high ranges favor optimal designs. The operating costs are proportional to the range, and the capital costs require an optimal relation between a high range and a low air flow rate; therefore, the strongest impact of the physical representation of the transport phenomenon is over the capital cost. For all cases analyzed here the minimum possible area was obtained, which means that the packing area is a major variable affecting the total annual cost. The cooling capacity of the inlet air determines the optimum relation between range and air flow rate. Since the model here presented is a non-convex problem, the results obtained can only guarantee local optimal solutions. Global optimization techniques must be used if a global optimal solution is of primary importance.

REFERENCES

- [1] Brooke, A., Kendrick, D., Meeraus, A. & Raman, R. (2006). *GAMS User's Guide (edition)*, The Scientific Press, USA.
- [2] Burden, R.L. & Faires, J.D. (2005). *Numerical Analysis (8th edition)*, Brooks/Cole Publishing Company, ISBN 9780534392000, California, USA.
- [3] Chengqin, R. (2006). *An analytical approach to the heat and mass transfer processes in counterflow cooling towers. Journal of Heat Transfer, Vol. 128, No. 11, (November 2006), pp. 1142-1148, ISSN 0022-1481.*
- [4] Cheng-Qin, R. (2008). *Corrections to the simple effectiveness-NTU method for counterflow cooling towers and packed bed liquid desiccant-air contact systems. International Journal of Heat and Mass Transfer, Vol. 51, No. 1-2, (January 2008), pp. 237-245, ISSN 0017-9310.*
- [6] Douglas, J.M. (1988). *Conceptual Design of Chemical Processes*, McGraw-Hill, ISBN 0070177627, New, York, USA.

National Conference on Current Trends in Engineering, Science and Technology (NACCTEST- 2018)
 Organized by GF's Godavari College of Engineering, Jalgaon
International Journal of Innovations in Engineering and Science, Special Conference Issue, 2018
 www.ijies.net

Design of Compact Condenser for Heat Recovery and COP Enhancement of Domestic Refrigerator

Miss. Harsha Gangaram Nathjogi¹, Mr. Vinayak G. Nathjogi², Asst. Prof. Tushar A. Koli³,
 Dr.V.H.Patil⁴

¹ Miss. Harsha Gangaram Nathjogi
 PG Student, Godavari College of Engineering, Jalgaon (425001)

² Mr. Vinayak Gangaram Nathjogi
 Smt.Kashibai Navale College of Engg.,Vadgaon,Pune

³Asst. Prof.Tushar A Koli
 Godavari College of Engineering, Jalgaon (425001)

⁴Dr.V.H.Patil
 Godavari College of Engineering, Jalgaon (425001)

¹Email:- harshanathjogi295@gmail.com

Abstract – Refrigerator is now an essential commodity. It is not a luxury item. The heat which is absorbed in refrigerated space and the compressor work added to refrigerant is rejected to environment through a condenser. Aim of this experiment is to recover waste heat from condenser unit of a domestic refrigerator, thereby improve the efficiency of the system. This paper presents research work on a design of compact condenser (shell and tube type) for effective heat recovery and cop enhancement of the household refrigerator. The condenser is located in such a way that thermo-syphon effect will be generated. Because of this system eliminate the use of pump to circulate the water. Known quantity of water is allowed to flow through the shell side of condenser. By changing the water flow rate through condenser required rise in temperature of water can be gained. Cop of the system can be increased up to 28.61%. Hot water having temperature about 50°C can be obtained within 20 minutes. This experiment will make the household refrigerator to be work as both refrigerator and water heater.

Keywords- VCR Cycle, COP, Shell and tube Heat exchanger, Recovery System.

INTRODUCTION

Energy saving is one of the major key issue, not only from the view of energy conservation but also

for environment. Energy conservation is now facing the challenge of applying the latest technology for improvement that can be justified on its own merits and demerits. Energy conservation is the technique which needs to be adopted to face energy crisis in future. Before rejecting waste heat to the environment, there can be utilization of thermal energy available in heat for some heating applications. Various thermal waste heat sources are available such as domestic and urban waste which includes heat losses in cooking appliances, heat losses in air conditioners, heat losses in HVAC systems etc. Waste heat recovery system can be used in many of these applications but in current experiment, we are focusing on heat recovery of air cooled domestic refrigerator. There are few problems with air cooled refrigerator. Refrigerator should be located away from the wall to have proper air ventilation. Proper care needs to be taken while handling or shifting due to bare copper tubes of condenser which lies at backside of refrigerator. These problems can also be eliminated by using this system.

National Conference on Current Trends in Engineering, Science and Technology (NACCTEST- 2018)
 Organized by GF's Godavari College of Engineering, Jalgaon
International Journal of Innovations in Engineering and Science, Special Conference Issue, 2018
 www.ijies.net

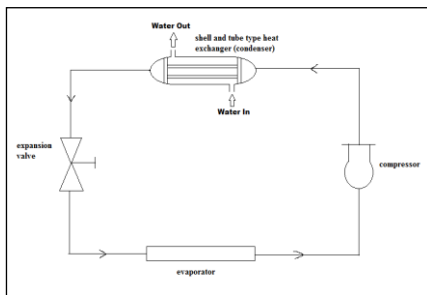

Fig 1. Block diagram of WHRS

we can use various refrigerants but generally R-134a is most preferable substitute for R-12 and has 74% less GWP than R-12. Now a day's refrigerator is not a luxury item and used in almost all middle class families, general stores for food preservation. In such refrigerator the refrigerant which flows in condenser, absorbs the heat from refrigerated space. Also heat gets added to refrigerant during compression. This total heat absorbed by refrigerant is then rejected to the atmosphere directly, through condenser. Therefore there is a scope to recover this waste heat and thereby conserve the energy. The main objectives of research work are to extract the heat from the domestic refrigerator by designing a compact condenser. Recover the heat in minimum possible time. And increase the COP and overall efficiency of the system. Power consumption or LPG consumption can be terminated for water heating. Hot water can be used for geysers, laundry, and dish washing like applications.

LITERATURE REVIEW

Already number of experimental studies had trying to recover the lost heat in domestic refrigerator systems. Many of these studies includes refrigerators modifications in terms of refrigerants, water-cooled condensers, waste heat recovery systems etc.

G.G Mominand Y.A.Patil has found that performance of the system can be increased by using thermosyphon technique which causes automatic water circulation. Therefore It eliminates the need of pump for circulation of water. Y.A.Patil and H.M. Dange has done the experiment on waste heat recovery from refrigerator by using a typical waste heat recovery unit. S.C.Walavade has discussed the effective and simple way of heat recovery by dividing the condenser into parts and mounting them in metal cabin. P.Elumalai has described

a case study on waste heat recovery by using hot oven and heater chamber at compressor outlet. Tarangagarwal has provides the cost effective method for cop enhancement of refrigerator by mounting the condenser coil in iron galvanized box. In this paper the efforts are made to replace the box with compact and efficient WHRU and improving the heat transfer rate between refrigerant and water.

SYSTEM DESCRIPTION

The cold water coming from the water tank sent to the condenser through the mass flow meter. The amount of water going to the condenser can be noted and adjusted with the help of mass flow meter. Water absorbs the heat rejected by the refrigerant in the condenser and leaves it as hot water. The control valve which is manually operated is assembled to the exit line of hot water. Therefore by closing this valve the time for which the water remains in the condenser can be adjusted and expected hot water temperature can be acquired. The working of this system is same as vapor compression refrigeration cycle.

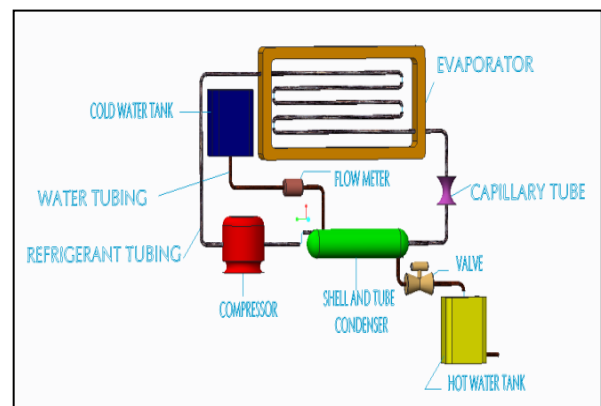

Fig 2. Block diagram of setup

The dimensions of condenser are determined by mathematical modeling which involves the calculations on heat transfer. The shell diameter and length is 6 cm and 40 cm respectively and the length of condenser is slightly less than width of refrigerator. So we can imagine how much compactness the condenser is having.

SPECIFICATION OF SYSTEM

Refrigerant	R-134a
Cooling capacity	365 Btu/hr

National Conference on Current Trends in Engineering, Science and Technology (NACCTEST- 2018)
Organized by GF's Godavari College of Engineering, Jalgaon
International Journal of Innovations in Engineering and Science, Special Conference Issue, 2018
www.ijies.net

Refrigerant Control	Capillary
Power input – Rated	100 watts
Compressor Cooling	Static
Displacement/revolution	4.00 cc
Evaporator temperature range	-34 to -12 °C
Evaporating temperature	-10°C
No of cylinders	One
Condensing temperature	40 °C
Return gas temperature	32 °C
Liquid sub cooling temperature	32 °C
suction temperature	32 °C
Suction (Evaporator) pressure	0.27579 Bar
Discharge (Compressor)pressure	13.7895

MATHEMATICAL MODELING

➤ Coefficient of Performance (COP) :

From steam table at pressure 0.27579 bar

$$h_1 = 366.94 \text{ KJ/kg}$$

$$s_1 = s_2 = 1.7826 \text{ KJ/kgK}$$

From steam table at pressure 13.7895 bar

$$S_2' = 1.7065 \text{ KJ/kgK}$$

$$h_2' = 424.08 \text{ KJ/kg}$$

From steam table at pressure 13.7895 bar

$$h_4 = hf_3 = 274.45 \text{ KJ/kg}$$

$$S_2 = S_2' + 2.3C_p \log(T_2/T_2')$$

$$T_2 = 67.61^\circ\text{C}$$

$$h_2 = h_2' + C_p(T_2 - T_2')$$

$$h_2 = 448.929 \text{ KJ/kg}$$

$$\text{COP} = \frac{h_1 - h_4}{h_2 - h_1}$$

$$\text{COP} = 1.128$$

➤ Total heat rejected by the condenser (Q) :

$$\text{Refrigerating Effect} = h_1 - h_{f3} = 92.49 \text{ KJ/kg}$$

For compressor:

$$\text{Motor power} = 1/8 \text{ HP} = 92 \text{ watt} \approx 100 \text{ watt}$$

$$\text{COP} = \frac{Q}{W}$$

$$Q_1 = 112.8 \text{ watt}$$

$$Q_2 = Q_1 + W = 212.8 \text{ watt}$$

Mass flow rate of refrigerant:

$$m_r = \frac{Q_2}{\text{RE}} = 0.002301 \text{ kg/s}$$

Heat available at condenser for Rejection:

$$Q = m_r * (h_2 - h_3) = 401.47 \text{ watt}$$

➤ Mass flow rate of water required (m_w) :

For mass flow rate of water:

$$Q = m_w * C_{p_w} * \Delta T$$

For to achieve desired temperature of hot water we can calculate the mass flow rate required of inlet water

For $\Delta T = 20^\circ\text{C}$

$$m_w = 0.004794 \text{ kg/s}$$

➤ Logarithmic mean temperature difference (LMTD) :

$$T_{c1} = 25^\circ\text{C}$$

$$T_{h1} = 67.61^\circ\text{C}$$

$$T_{c2} = 45^\circ\text{C}$$

$$T_{h2} = 37^\circ\text{C}$$

For counter flow heat exchanger:

$$\Delta T_1 = T_{h1} - T_{c2} = 22.61^\circ\text{C}$$

$$\Delta T_2 = T_{h2} - T_{c1} = 12^\circ\text{C}$$

$$\text{LMTD} = \frac{\Delta T_1 - \Delta T_2}{\ln\left(\frac{\Delta T_1}{\Delta T_2}\right)} = 16.7486$$

➤ Overall heat transfer coefficient (U) :

For h_i and h_o calculation:

$$T_{\text{mean}} = \frac{T_{\text{win}} + T_{\text{Rout}}}{2} = 31^\circ\text{C}$$

Properties of water at 31°C :

For water side:

$$hf_g = 2431 \text{ KJ/kK}_f = 0.165 \mu = 0.798 * 10^{-3} \text{ kg/mD} =$$

$$0.053 \text{ m} = 53 \text{ mm}$$

Heat transfer coefficient for water side (h_i)

$$h_i = 0.725 \left[\frac{\rho^2 * g * hf_g * K_f^3}{\mu * D * (T_o - T_i)} \right]$$

Heat transfer coefficient for water side (h_i) = 475.98

For refrigerant side:

$$hf_g = 179.1 \mu = 1.83 * 10^{-4} \text{ K}_f = 0.00342$$

Similarly heat transfer coefficient for refrigerant side (h_r)

$$= 225.38$$

Fouling factor for Refrigerant (f_r) = 0.00017

Fouling factor for water (f_w) = 0.00017

$$\frac{1}{U} = \frac{1}{h_i} + \frac{1}{h_r} + \frac{\mu}{K} + f_r + f_w$$

$$U = 145.38 \text{ w/m}^2\text{k}$$

➤ Total Area required for heat recovery (A) :

$$Q = U * A * \text{LMTD}$$

$$A = 0.16488 \text{ m}^2$$

$$R = \left[\frac{T_{c1} - T_{c2}}{t_{h2} - t_{h1}} \right]$$

$$R = 0.4533$$

$$S = \left[\frac{t_{h2} - t_{h1}}{T_{c1} - t_{h1}} \right]$$

$$S = 0.7183$$

National Conference on Current Trends in Engineering, Science and Technology (NACCTEST- 2018)
 Organized by GF's Godavari College of Engineering, Jalgaon
International Journal of Innovations in Engineering and Science, Special Conference Issue, 2018
 www.ijies.net

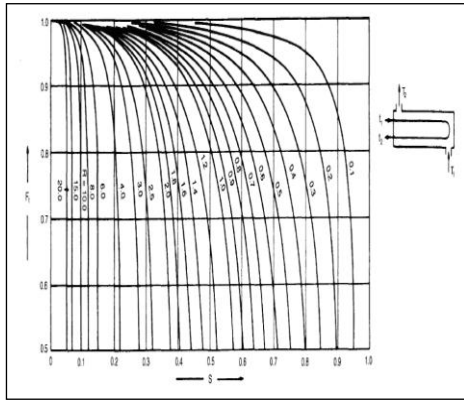

Fig 3. Temperature correction factor: one shell pass; two or more even tube 'passes

From graph

$f_t = \text{Temp correction factor} = 0.85$

New LMTD = $16.7486 * 0.8 = 14.23631 \text{ }^\circ\text{C}$

New Area = $\frac{Q}{U * \text{newLMTD}} = 0.1939 \text{ m}^2$

➤ Length of copper tube required (L) :

Area = $\pi * D_o * L * N_t = 10.286 \text{ m}^2$

➤ Total no of copper tubes required (N_t) :

No of turns $N_t = \frac{L}{\text{Fixed distance 'L' is assumed}} = 21.42$

≅ 22 Tubes

➤ Tube pitch (P_t) :

$P_t = 1.25 * d_o = 0.75 \text{ mm}$

➤ Bundle diameter (D_b) :

$D_b = d_o * \left(\frac{N_t}{K_1}\right)^{1/n_1}$

For 1 pass: Triangular Pitch

$K_1 = 0.319 \quad n_1 = 2.412$

$D_b = 4.33 \text{ cm}$

➤ Bundle diameter clearance (BDC) :

Bundle diameter clearance (BDC) = 10 mm

➤ Shell diameter (D_s) :

Shell diameter (D_s) = $D_b + BDC = 5.33 \text{ cm}$

➤ Baffle spacing (B_s) :

Baffle spacing (B_s) = $1.8 * D_s = 9.6 \text{ cm}$

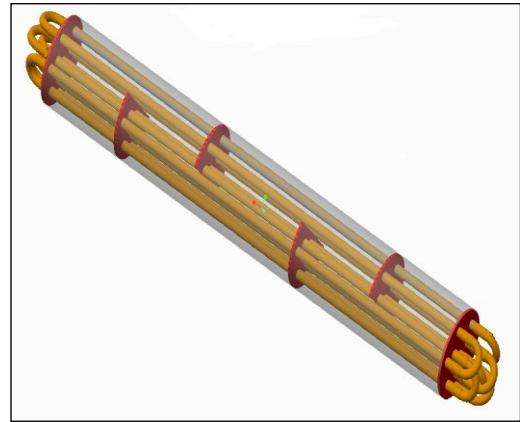

Fig 4. CAD model of shell and tube condenser

CAD model is designed as per the dimensions obtained from mathematical modeling. CREO software is used for the designing.



Fig 5. Actual model of shell and tube condenser

OBSERVATION TABLE

Time In Minutes	Compressor Outlet Temp.	Water Outlet Temp.	Evaporator Temperature
0	40.1	33.2	12
5	43.3	39.5	11
10	46.2	43	9.5
15	48.6	46.9	4.1
20	49.8	47.9	2.2
25	50.4	48.3	0.8
30	51.8	48.2	-0.1

National Conference on Current Trends in Engineering, Science and Technology (NACCTEST- 2018)
 Organized by GF's Godavari College of Engineering, Jalgaon
International Journal of Innovations in Engineering and Science, Special Conference Issue, 2018
 www.ijies.net

35	52.3	47.9	-0.3
40	52.8	48	-0.1
45	52.9	47.4	-0.5
50	56.1	48.2	-0.9
55	58.3	48.5	-1.2
60	58.3	48.7	-1.4
65	60	49.3	-1.4
70	59.9	49.7	-1.3
75	61	49.9	-1.4
80	60	49.6	-1.6

From the observations we can see that the temperature of water increase to 48⁰c within 20 minutes only. Maximum temperature of water which can be achieved is 50⁰c.

RESULTS AND CALCULATIONS

COP CALCULATIONS

Time required for 10 impulse = 60 sec

Trial duration = 10 minutes

Energy meter constant=3200 imp/kw hr

$$= 1000*(3600/3200)$$

$$= 1125 \text{ watt}$$

$$\text{Work supplied to compressor} = \frac{1125*10}{60} \text{ watt}$$

$$=0.1875\text{kw}$$

For 25 liters load on system

Cop of old system:-

$$\frac{\text{Refrigerating effect}}{\text{Work supplied}} = \frac{\text{Produced}}{\text{Work supplied}}$$

$$\left(\frac{\text{mass of water} * \text{cp} * \text{temperature rise for 10 minutes}}{\text{trial duration in seconds}} \right) =$$

$$=25*4.187*1.25)/(60*10)$$

$$= 0.2180 \text{ kw}$$

$$\text{Cop} = \frac{\text{refrigerating effect}}{\text{work supplied}} = 1.162$$

Similarly cop of new system

Time for 10 impulse = 84 sec

New cop =1.6277

$$\% \text{ improvement in cop} = \left(\frac{\text{new cop} - \text{old cop}}{\text{new cop}} \right) * 100$$

$$= 28.61 \%$$

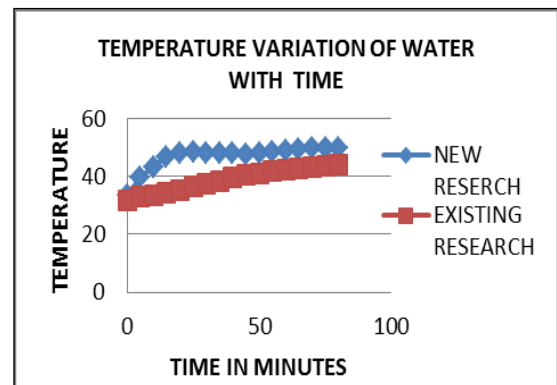

Graph 1. Time vs Temperature rise graph
 System takes only 20 minutes to raise the temperature of water to 48⁰c. Maximum temperature which can be obtained is 50⁰c.as per earlier researches; system takes 2 hours of time to raise the temperature to 50⁰c.

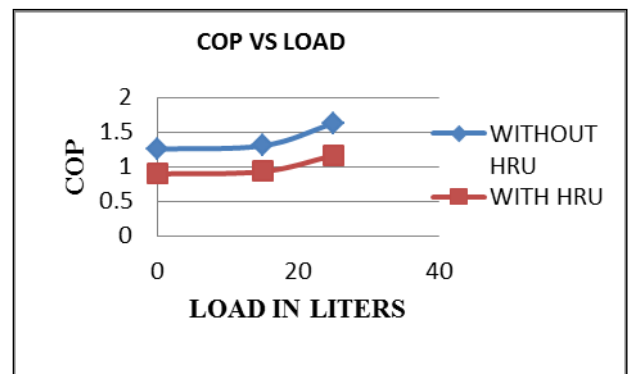

Graph 2. Load vs Actual COP graph
 Actual COP of the system with compact condenser is more than system with existing air cooled condenser system. COP has improved to 28.61 %.

National Conference on Current Trends in Engineering, Science and Technology (NACCTEST- 2018)
Organized by GF's Godavari College of Engineering, Jalgaon
International Journal of Innovations in Engineering and Science, Special Conference Issue, 2018
www.ijies.net

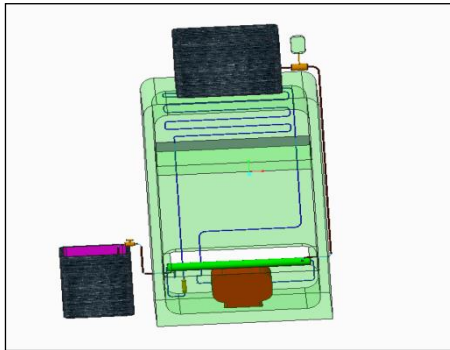

Fig 6. CAD modeling of setup

The green color represents the condenser. The condenser is mounted just above the compressor. The surface area required for this condenser is much lesser than air cooled condenser. So it saves lot of space which is wasted for mounting air cooled condenser.

ACTUAL EXPERIMENTAL SETUP



Fig 7. Actual experimental setup

CONCLUSION

- The maximum temperature achieved in the water Storage tank at 25 liter load is 50 °C within 20 minutes.
- Power Consumption is reduced by using water cooled (HRU) condenser instead of air cooled.
- Cop of system increased to 28.61 %
- The designed condenser is much compact and can be adjusted easily in the vacant space available above compressor.
- It reduces the handling problems of refrigerator and reduces chances of leakage of refrigerant from bare copper tube.
- Recovery of heat from the condenser reduces the heat load to surrounding and it makes surrounding comfortable

REFERANCES

- [1] Y.A.Patil, H.M.Dange, *Improving the Performance of Household Refrigerator by Recovering Heat from the Condenser. International Journal of Science and Research (IJSR), India Online ISSN: 2319- 7064 Volume 2 Issue 6 (2013)*
- [2] Sreejith.K., *Experimental Investigation of A Domestic Refrigerator Having Water-Cooled Condenser Using Various Compressor Oils". Research Inventy: International Journal Of Engineering And Science Issn: 2278-4721, Vol. 2, Issue 5 (February 2013), pp 27-31 (2013)*
- [3] Momin, G.G., Deshmukh, S.R., Deshmukh, M.T., Chavan, P.T., Choudhari P.P., *Cop Enhancement of Domestic Refrigerator by Recovering Heat from the Condenser. International Journal of Research in Advent Technology, Vol.2, No.5, May 2014 E-ISSN: 2321-9637 (2014)*
- [4] Jay J. Bhavsar, V K. Matawala, S.B.Dixit, *Performance Analysis of Spiral Tube Heat Exchange, International Journal of Engineering and Advanced Technology (IJEAT) ISSN: 2249 – 8958, Volume-2, Issue-4, (April 2013)*
- [5] S. C. Walawade, B.R. Barve, P. R. Kulkarni, *Design and Development of Waste Heat Recovery System for Domestic Refrigerator, IOSR Journal of Mechanical and Civil Engineering (IOSR-JMCE) ISSN: 2278-1684, PP: 28-32*
- [6] Tanmay Patil, Nitesh Medhane, Yogesh Mahapure, Kalpesh Nagmoti, Prof. Anil Dube, *A Review On Recovering Waste Heat From Condenser Of Domestic Refrigerator, International Journal of scientific research and management (IJSRM), Volume 3, Issue 3, Pages 2409-2414 (2015)*
- [7] P. Elumalai, R. Vijayan, K.K. Ramasamy and M. Premkumar, *Experimental Study on Energy Recovery from Condenser Unit of Small Capacity Domestic Refrigerator, Middle-East Journal of Scientific Research 23 (3): 417-420, 2015 ISSN 1990-9233 © IDOSI Publications, (2015)*
- [8] Tarang Agarwal, Manoj Kumar, Praveen Kumar Gautam, *Cost-Effective COP Enhancement of a Domestic Air Cooled Refrigerator using R-134a Refrigerant, International Journal of Emerging Technology and Advanced Engineering Website: www.ijetae.com (ISSN 2250-2459, ISO 9001:2008 Certified Journal, Volume 4, Issue 11, November 2014)*
- [9] *Refrigeration and air conditioning by R.S.Khurmi and Gupta, fifth edition.*

National Conference on Current Trends in Engineering, Science and Technology (NACCTEST- 2018)
Organized by GF's Godavari College of Engineering, Jalgaon
International Journal of Innovations in Engineering and Science, Special Conference Issue, 2018
www.ijies.net

Energy Involvement in the Transportation of Building Materials

Kishor M. Mahajan¹, Tushar A. Koli², Dr.V. H. Patil³

¹ Assistant Professor,
GF'S GCOE, Jalgaon, India, 425501

² Assistant Professor,
GF'S GCOE, Jalgaon, India, 425501

³ Associate Professor
GF'S GCOE, Jalgaon, India, 425501
¹Email:- mahajankishor87@gmail.com

Abstract –The embodied energy is a significant factor in the whole life energy consumption of a building. Its proportion of the total energy consumption attributable to a building throughout its life is increasing as improvements in thermal performance and energy efficiency of systems reduce the energy consumption during the occupied phase of the building life. The embodied energy can include all energy attributed to a building material from its original source through to construction on site. This paper considers the component of embodied energy that is attributable to the transportation of the materials. It is based on a case study undertaken of a single construction site, determining the energy consumed in transporting the construction materials to site. The results of this study are based on the energy consumed in delivery only, the fuel consumed for a one way delivery journey. Literature search identified that common assumptions made by different researchers when evaluating transportation by road vary between 1.18 - 4.5 MJ/tonne/km. However these figures are assumed to include allowances for other aspects of the energy consumed that can be attributed to transportation such as return journeys and the manufacture and maintenance of vehicles and roads. The paper shows that for a particular study of a site in Brighton 1.5% of the total embodied energy was attributed to the energy consumed in the delivery of the materials. Part load delivery and packing ratio are identified as factors affecting the energy consumed in transportation of materials and these issues are discussed with reference to the Brighton case study.

Keywords- Embodied Energy, Transportation

INTRODUCTION

Life cycle of a building commences with the winning of the raw materials that are used to produce building materials and components and ends with the final disposal of those materials after demolition of the building and the reuse or recycling of suitable products. It includes all of the stages of construction, operation and demolition as depicted in fig. 1.

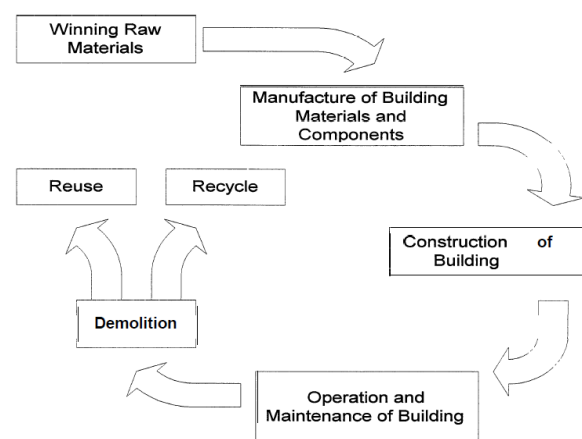

Fig. 1 Environmental Lifecycle of Buildings

Throughout its life cycle a building will consume energy, generally in the form of fossil fuels. The consumption of fossil fuels results in the depletion of natural resources and in the production of pollution with its subsequent problems such as global warming and

National Conference on Current Trends in Engineering, Science and Technology (NACCTEST- 2018)
 Organized by GF's Godavari College of Engineering, Jalgaon
International Journal of Innovations in Engineering and Science, Special Conference Issue, 2018
 www.ijies.net

acid rain. It is estimated that more than 50% of UK energy consumption can be attributed to buildings and a similar proportion of the carbon dioxide emissions. Much research has been aimed at understanding the energy consumption of occupied buildings and at reducing that consumption. However it is estimated that the delivered energy embodied in the constituent building materials and components is 350 PJ per annum (equivalent to 20% of the annual energy consumption in the UK domestic sector) and is responsible for 8% of the national carbon dioxide emissions. (1) This paper is based on research undertaken at the University of Brighton aimed at improving our knowledge of the total embodied energy of building materials. In particular it studies the component of the embodied energy that is attributable to the transportation of those materials. The research project was sponsored by the Engineering and Physical Sciences Research Council.

EMBODIED ENERGY

The embodied energy of a building material or component is the total energy consumed in winning the raw materials, manufacturing the components and constructing the building on site. It includes the energy consumed for transportation within and between each of the stages leading to the completed building as shown in fig.2.

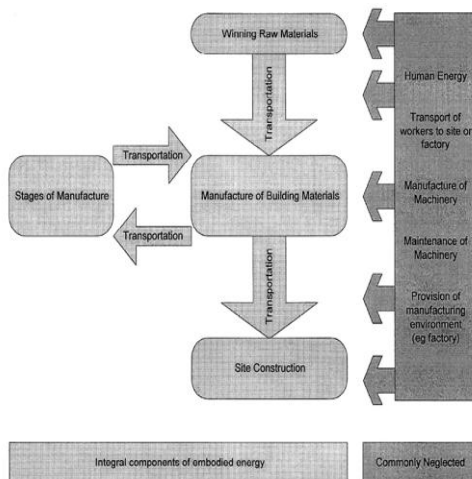

Fig. 2 Components of Embodied Energy of a Building

Boundaries

A full audit of the embodied energy of any item can be very complex and there are diminishing returns with

respect to the accuracy of the calculation the further removed the analysis becomes from the item under consideration. As a result the evaluation is often simplified and Fig.2 presents a commonly accepted definition of the embodied energy of a building. Calculated in this way embodied energy figures are clearly site specific. They are related to the specific materials, suppliers and efficiency of distribution and delivery route. There is however generally no need for such a precise figure to be determined in order to provide useful data for building designers. Published embodied energy figures for common building materials vary enormously and there is often little indication of what has been included in the analysis or how they have been obtained. Common exclusions are shown down the right hand side of Fig.2 but the transportation component is also often omitted or considered using gross simplifications.

TRANSPORTATION ENERGY

This paper focuses on the energy consumed in transporting building materials from their origin to the building site and highlights a wide variation for different materials. It is appreciated that the transportation component of embodied energy is often small compared to the total embodied energy of a material, but investigations have shown that in general, oversimplifications are made when estimating this component. It is common practice to estimate transportation energy embodied in building materials through the use of a standard consumption in MJ/tonne/km. Estimations of energy consumed in the transportation of building materials vary considerably and table 1, based on an original by Lawson (2), presents published figures for estimates used in Canada, Denmark, the UK and the USA. There is however no indication of the basis on which these figures were determined and comparisons are therefore dangerous.

Table1. Published figures for vehicle transportation energy

Road vehicles		
Country	MJ/tonne/km	Reference
Canada	1.18	[3]
Denmark	1.14	[4]
UK	4.50	[1]
USA	2.13	[5]

National Conference on Current Trends in Engineering, Science and Technology (NACCTEST- 2018)
Organized by GF's Godavari College of Engineering, Jalgaon
International Journal of Innovations in Engineering and Science, Special Conference Issue, 2018
www.ijies.net

The research undertaken at Brighton has focused on the delivery of materials to a single building site situated on the Brighton seafront and full details of the measurements have been published elsewhere (6). Vehicle fuel consumptions were calculated based on the consumption of diesel with a calorific value of 35.7 MJ / 1 and vehicle efficiencies were based on the miles per gallon figures published in Philips (7). A summary of the results of this study is given in table 2. The energy consumption figures are an order of magnitude lower than the estimates shown in table 1, however they represent only the energy consumed in the process of delivery and not the total amount of energy that can be attributed to the transportation of the materials.

MATERIAL	MJ/tonne/km
RMC Concrete	0.10
RMC mortars	0.05
Dense concrete blocks	0.02
High density blocks	0.09
Concrete lintels	0.72
Structural steel steam beams	0.08
Steel shuttering	0.16
Concrete reinforcement	0.36
Roofing timber	0.15
Chipboard flooring	0.29
Plasterboard	0.24
External plaster	0.62
Internal plaster	0.48
Windows	0.33
Roof slates	2.55
Celtex insulation	7.92
Angle ties	49.24
Zinc phosphate paint	1.34

Figures estimating the total energy consumed in transportation would include:

- Fuel consumption in the delivery of materials
- Fuel consumption in the return journey of the delivery vehicle
- Attributable proportion of the energy consumed in the manufacture and maintenance of the vehicles

- Attributable proportion of the energy consumed in the construction and maintenance of the roads

The components found to consume the most energy in transportation in the Brighton study were the steel beams, accounting for 18% of the total energy consumed in transportation. The steel shuttering *and the ready mixed concrete were the other major proportions of the transportation energy, each representing approximately 11% of the total. It has been shown that these figures, based on consumption for delivery only, represent approximately 1.5% of the total embodied energy of the materials, when related to an average of published embodied energy figures.

IDENTIFICATION OF KEY ISSUES

Analysis of the results identifies that the delivered quantity of materials and the relationship to the maximum payload of the delivery vehicles are important factors in determining the energy consumed in transportation. Vehicles may not be carrying their full payload capacity for a number of reasons and these are considered further under the headings of part load and packing ratio.

Part Load

A construction site may have received part load deliveries because:-

- The total site requirements are for less than a full load and the manufacturer or Transport Company cannot schedule a full load.

An example of this can be seen in the delivery of angle ties of which only 0.1 tonnes were required on the site. These were delivered as a single load in a 4.5 tonne truck over a distance of 369 km.

/There are of course a number of reasons why some deliveries need to be made in this way, but the relative energy cost is high. Careful planning of ordering schedules from the site and delivery schedules from the supplier would reduce this component.

- The restrictions on site storage are such that the total requirements for a material cannot be ordered at one time resulting in part load orders.

National Conference on Current Trends in Engineering, Science and Technology (NACCTEST- 2018)
Organized by GF's Godavari College of Engineering, Jalgaon
International Journal of Innovations in Engineering and Science, Special Conference Issue, 2018
www.ijies.net

This problem was experienced in the delivery of thermal blocks where the 3 14 tonnes required were delivered in 22 separate deliveries. On this occasion it was not caused by part loading individual vehicles as smaller vehicles were used, but naturally the overall distance travelled was far greater than it needed to be.

- Security on the site is such that sub-contractors are unwilling to order the full requirements for fear of theft.

Loose materials are generally the responsibility of the sub-contractor until built into the building. Valuable materials that can easily be removed from site are therefore often delivered in small quantities. On this site the plaster for the building was delivered in 14 separate journeys, once again increasing the distance travelled. However in this case the final legs of the deliveries, from supplier to site, were also at only 65% of the possible payload. These issues will be affected by the material's distribution network, the management of the transportation system and the site management. The ability to organise full load distribution will be affected by whether the transportation is being undertaken by a manufacturers supplying their own products or by a specialist haulage contractor's who might have the opportunity to plan a more efficient schedule for individual vehicles.

Packing Ratio

The nature of the building materials or components being transported dictate the type of vehicle being used which may result in the maximum load not being carried.

- The physical shape of the materials or components may make it impossible to load the vehicle to its maximum load.

The steel shuttering was a typical example of this effect as for each section of the journey the vehicles were only carrying approximately 25% of their payload capacity.

- The density of the material may be so low that it occupies a large volume.

The rigid insulation materials used on the site weighed a total of 1.1 tonnes but for the two legs of the journey travelled in a 25 tonne and 18 tonne vehicles. These

results do not identify inefficiencies in delivery but highlight limitations of the existing transportation system.

CONCLUSION

The key factors raised by this study are widely applicable and their sensitivity need to be considered whenever embodied energy figures are evaluated.

The transportation energy calculated in this study, based on fuel consumption for delivery only, represents approximately 1.5% of the total embodied energy when published embodied energy figures are used. This figure will naturally increase when return journeys, vehicle manufacture and maintenance and the road network infrastructure are considered. Further, it relates to published embodied energy figures, which themselves vary by more than 100% in some instances. Nevertheless it serves as an indicator as to the significance of the transportation component for individual materials.

The key factors of part load and packing ratio have been analysed identifying common occurrences that make it impossible to optimise the efficiency of delivery. The more obvious factors of vehicle used, distance travelled and route taken, have also been considered and extenuating circumstances identified.

REFERENCES

- [1] West, J., Atkinson, C. and Howard, N. *Embodied Energy and Carbon Dioxide Emissions for Building Materials. First International Conference on Buildings and the Environment, CIB TGS, BRE Watford, UK (1994)*
- [2] Lawson, W. *Embodied Energy of Building Materials, Environmental Design Guide, Royal Australian Institute of Architects. (1995)*
- [3] Trusty W.B. *Unit Factor Estimates, Model Development and Related Studies, Phase 2 Summary Report, Forintek Canada Corporation. (1993)*
- [4] Krogh H. *Personal Communication. Danish Building Institute (1994)*
- [5] Malin N, *on using Local Materials, Environmental Building News, Volume 5No. 5, (1996)*
- [6] Miller A. J. *Transportation Energy Embodied in Construction Materials, 2nd International Conference on Buildings and the Environment, Vol 1 ~477-484, CIB TG 8, Paris. (1997)*
- [7] Philips, *Transport Cost Tables, Motor Transport, Nov. 16 (1995)*

National Conference on Current Trends in Engineering, Science and Technology (NACCTEST- 2018)
 Organized by GF's Godavari College of Engineering, Jalgaon
International Journal of Innovations in Engineering and Science, Special Conference Issue, 2018
 www.ijies.net

CFD Simulations of 2D Venturimeter

Prof. Narkhede Laxmikant P.¹, Mr. Limesh V. Mahajan², Mr. Pratik S. Lad³

¹Assistant Professor, ²Student, ³Student
 BCOE, Badlapur, Maharashtra, India. 421503
¹Email:- narkhedelaxmikant@gmail.com

Abstract – The venturimeter is a typical obstruction type flow meter, widely used in various sectors for flow measurements. The present work deals with the study of the flow of venturimeter and demonstrates the use of technology by improving mass flow rate in it. This study of venturimeter gives necessary pressure drop across venture section by increasing the velocity. A Venturi meter is a tube with a constricted throat that increases velocity and decreases pressure. Venturi meters are used for measuring the flow rate of both compressible and incompressible fluids in a pipeline. Drawing exploration from AutoCAD Workbench is used in the study. The computational fluid dynamics (CFD) software ANSYS FLUENT-14 has been used as a tool to perform the simulation of venturimeter. The objective of the study was to maximize the mass flow rate of Venturimeter. Numerical results were compared with CFD Simulations for its accuracy and to develop a standard methodology for future iterations. It uses a finite-volume method, the $k-\epsilon$ turbulence model, and a multigrid method. The calculated results for velocity and pressure distributions are discussed. The mass flow rates through the Venturimeter pipes are shown to be in good agreement with the measured values.

Keywords – venturimeter, AutoCAD, CFD, mass flow rate, $k-\epsilon$ turbulence model

INTRODUCTION

The venturi meter is an obstruction meter named in honor of Giovanni Venturi (1746–1822), an Italian physicist who first tested conical expansions and contractions. The original, or classical, venturi was invented by a U.S. engineer, Clemens Herschel, in 1898. It consisted of a 21° conical contraction, a straight throat of diameter d and length d , then a 7 to 15° conical expansion. The discharge coefficient is near unity, and

the non recoverable loss is very small. The modern venturi nozzle consists of an ISA 1932 nozzle entrance and a conical expansion of half angle no greater than 15° . It is intended to be operated in a narrow Reynolds-number range of 1.5×10^5 to 2×10^6 [3]. Venturi meters consist of a short length of pipe shaped like a vena contracta, or the portion with the least cross sectional area, which fits into a normal pipe-line. The obstruction caused to the flow of liquid at the throat of the venturi produces a local pressure drop in the region that is proportional to the rate of discharge. Hence a more sophisticated method of testing the flow meter is through numerical methods. Due to a variety of commercial CFD codes being available in the market, it is possible to obtain more accurate results which take less time. These results can then be compared with the initial experimental results to calibrate the instruments. [1]

Venturimeter are commonly used in single and multiphase flows. CFD methodology also has been used to analyze the effect of various parameters like surface roughness, convergent and divergent angle as well as turbulent intensity of the incoming flow on the effects of compressibility of fluids that are being meter. [2]

Due to the rapid increase in computing processing power and technology over the past two decades, Computational Fluid Dynamics (CFD) has become an essential tool, in addition to experimental and analytical methods, for the solution and analysis of fluid mechanics and heat transfer problems. [3]

Bernoulli's Principle

The Venturi effect is a special case of Bernoulli's principle, in the case of fluid or air flow through a tube or pipe with a constriction in it. Bernoulli's principle can be derived from the principle of conservation of energy. This states that, in a steady flow, the sum of all forms of mechanical energy in a fluid along a streamline is the same at all points on that streamline. This requires that the sum of kinetic energy and potential energy remain constant. Thus an increase

National Conference on Current Trends in Engineering, Science and Technology (NACCTEST- 2018)
Organized by GF's Godavari College of Engineering, Jalgaon
International Journal of Innovations in Engineering and Science, Special Conference Issue, 2018
www.ijies.net

in the speed of the fluid occurs proportionately with an increase in both its dynamic pressure and kinetic energy, and a decrease in its static pressure and potential energy. If the fluid is flowing out of a reservoir, the sum of all forms of energy is the same on all streamlines because in a reservoir the energy per unit volume (the sum of pressure and gravitational potential $\rho g h$) is the same everywhere. [4]

Bernoulli's Equation

Energy is conserved in a closed system, that is, the sum of potential and kinetic energy at one location must equal the sum of the potential and kinetic energy at any another location in the system. If potential energy decreases at one location, the kinetic energy must proportionally increase at that location. The fluid now enters the throat of the Venturi with a new area A_2 , which is smaller than A_1 . In a closed system mass can be neither created nor destroyed (law of conservation of mass, simply, what goes in, must come out), and as such, the volumetric flow rate at area A_1 must equal the volumetric flow rate at area A_2 . If the area at location A_2 is smaller than A_1 , the fluid must travel faster to maintain the same volumetric flow rate. This increase in velocity results in a decrease in pressure which follows Bernoulli's equation. [4]

- Euler's equation of motion :
 $dp/\rho + dz/g + vdv = 0$

- Bernoulli's equation of motion :
 $P/\rho + u^2/2 + z g = \text{constant}$

It states that in a steady, ideal flow at an incompressible fluid, the total energy at any point of fluid is always constant. Total energy = Constant

Where,

$P/\rho g$ = pressure energy or Pressure head per unit weight.

$U^2/2g$ = kinetic energy or Kinetic head per unit weight.

Z = potential energy or datum energy.

- Assumptions made in Bernoulli's equation :
1) The fluid is ideal, steady and continuous, incompressible, Irrotational.
2) The velocity is uniform over the cross section.

All practical fluids are viscous and after resistance to fluid flow. So that there is some losses in fluid flow between two section. Bernoulli's equation was derived

on the assumption that fluid is non viscous. Applications are Venturimeter, Orifice, and Pilot Tube. Venturimeter: It is a device used to measure rate of flow of fluid flowing through pipe lines. As, Velocity increases | Area decreases | Pressure energy decreases.

$$P_1/\rho g + V_1^2/2g + Z_1 = P_2/\rho g + V_2^2/2g + Z_2$$

PROBLEM DEFINITION

Aim of the present work is to increase the mass flow rate of air. CFD simulations are carried out on Venturie Nozzle pipe geometric model as shown in AutoCAD Figure-1. In which Inlet pressure is 2 bar and 40mm diameter. Throat diameter is 20mm diameter. Outlet Pressure is 1 bar and 40mm diameter. From these values we can calculate mass flow rate which is 17kg/sec to 20kg/sec.

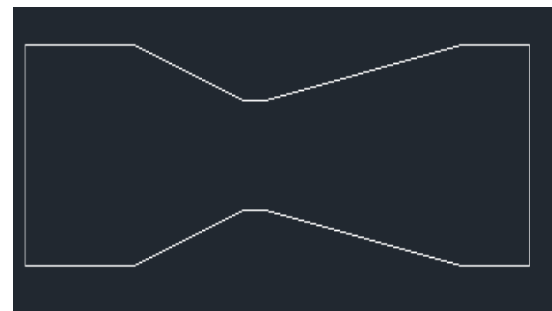

Fig.1- Venturie Nozzle pipe



Fig. 2- Experimental Set up

LITERATURE SURVEY

Nikhil Tamhankar et.al. worked on "Experimental and CFD analysis of flow through venturimeter to determine the coefficient of discharge" Authors have studied to prepare a computational model of a venturimeter, which can be used as an efficient and easy means for calibration of the instrument instead of costly experimental methods. The research covers the

National Conference on Current Trends in Engineering, Science and Technology (NACCTEST- 2018)
 Organized by GF's Godavari College of Engineering, Jalgaon
International Journal of Innovations in Engineering and Science, Special Conference Issue, 2018
 www.ijies.net

following aspects: to study the theory of the venturimeter and calculate the data theoretically by using Bernoulli's equation, to analyse the experimental data and to plot graphs for it. The focus here is to analyse the pressure variations across the venturi section by means of Ansys Fluent 13.0, a commercial CFD code, which explores the use of computational methods to compute the flow parameters in the tube. The study aims at comparing the results calculated by both, the computational and experimental methods. [1]

Prasanna M A et.al. worked on "numerical analysis of compressible effect in the flow metering by classical venturimeter" an attempt is made to study and develop a computational model of a Venturimeter, which can be used as an efficient and easy means for predicting the compressibility effect using Computational Fluid Dynamics (CFD) software.

It is observed that increase in the convergent-divergent angles beyond the standard values has no significant effect on the values of C_d and ϵ . However increase in the divergent angle results in significant increase in the value of CPL. Increase in the value of relative wall roughness factor (K/D) beyond 0.00001, decreases the value of C_d for incompressible flow. However the values of ϵ and C_d for compressible flow are not very much affected. Increase in the turbulent intensity of the incoming flow from 0.1 to 10% doesn't alter the values of performance parameters of the Venturimeter significantly. [2]

N. P. Gulhane et.al. worked on "Analysis of Pressure and Velocity at the Throat of Self-Priming Venturi Scrubber" the filtered vented containment system (FVCS) containing venturi scrubber is being installed in order to prevent the particulate matter and gaseous pollutant entering the environment due to severe accidents in nuclear power plant. Three-dimensional modeling is done, in order to analyze pressure and velocity of fluid at the throat of self priming venturi scrubber. The pressure at throat helps to understand volumetric liquid to gas ratio inside venturi scrubber. This work is helpful to improve the venturi design for good performance. [5]

Anshul Singhal. Et.al worked on "Air Flow Optimization via a Venturi Type Air Restrictor" the aim is to allow the engine to achieve the maximum mass flow with minimal pull from the engine. In short, the pressure difference between atmosphere and the pressure created in the cylinder should be minimal, so that

maximum airflow into the engine at all times. From the data gathered through the numerous simulations in Solid Works Flow Simulation, it can be observed that the optimized values for converging angle and diverging angle of the [6]

Pranav Anil Shinde worked on "Research and optimization of intake restrictor for Formula SAE car" This research paper aims to optimize a venturi type restrictor which is to be fitted in the intake manifold of a Formula SAE car engine. Objectives of this research is to optimize a venturi type design to allow maximum possible mass flow rate to the engine from 20 mm restrictor by reducing the difference in pressure across venturi at all speeds. Analytical calculations are done based on standard results to get maximum mass flow rate and CFD tool is used to calculate minimum pressure drop across the restrictor by varying converging and diverging angles of venturi. It can be observed from CFD results that for converging and diverging angle of 12 degrees and 6 degrees respectively minimum pressure drop can be achieved. From all the research done till now it is clear that at converging angle of 12 degree and diverging angle of 6 degree we get maximum recovery of pressure. Computational fluid dynamics played important role in all analysis. [7]

Shashwat Sharma .et.al. Worked on "A study on Optimization of Flow through Venturi of a Carburettor" Even then there is a high fuel consumption because of many factors. One of the important factors that affect the fuel consumption is that design of carburetor. The venturi of the carburettor is important as it provides a necessary pressure drop in the carburetor device. In this work two parameters namely pressure drop and fuel discharge nozzle angle of the carburettor will be analyzed using computational fluid dynamics. CFD analysis of the carburettor has been done by solid works and results obtained are used for optimum design of a carburettor. [8]

P. Hari Vijay et.al. worked on "CFD simulation on different geometries of venturimeter" This paper describe an analytical approach for comparison of four different models to describe the velocity, pressure, turbulence and mass flow rate taken place in the venturimeter and graph are plotted. Venturimeter are most commonly used for flow meters for measuring volumetric or mass flow rate and velocity of fluid flowing through the venturimeter. Hence are also known as variable head meters. [9]

National Conference on Current Trends in Engineering, Science and Technology (NACCTEST- 2018)
Organized by GF's Godavari College of Engineering, Jalgaon
International Journal of Innovations in Engineering and Science, Special Conference Issue, 2018
www.ijies.net

Arun R. et.al. Worked on “CFD Analysis of the Effect of Defects in Welding and Surface Finish on the Performance Characteristics of Venturimeter” the present work, an attempt is made to study and prepare a computational model of a venturimeter, which can be used as an efficient and easy means for predicting the discharge coefficients at different non-standard conditions. [10]

Chandan D. Chaudhari et.al. Worked on “Numerical Analysis of Venturi Ducted Horizontal Axis Wind Turbine for Efficient Power Generation” In this paper the venturi effect was used to concentrate the air flow to the turbine blades with convergent section, which increases the velocity at turbine blades and low pressure region created behind the blades by divergent section, whereas turbine was mounted at the throat section.

The aim of the project is to reflect an idea of wind power plant in the urban areas where wind velocity is low. The increased velocity of wind resulted in significant improvement in the kinetic energy hence power output of turbine. [11]

C. R. Sanghani et.al. Worked on “Effect of Geometrical Parameters of Venturimeter on Pressure Drop” In the present work, Computational Fluid Dynamics (CFD) has been used to investigate the effect of different geometrical parameters like convergent cone angle, divergent cone angle, and diameter ratio and throat length on pressure drop in Venturimeter. Effect of each parameter has been checked by varying one parameter and keeping three parameters constant at a time. From simulation results, it was found that pressure drop fluctuates with increase in convergent cone angle, divergent cone angle and throat length while reduces with increase in diameter ratio. [12]

CALCULATION PARAMETER

Navier-Stokes equations are vector equations, meaning that there is a separate equation for each of the coordinate directions. But as we can see, all the above calculations have been made based on one assumption – Incompressible Flow. The conservation of mass is a fundamental concept of physics. Within some problem domain, the amount of mass remains constant; mass is neither created nor destroyed. The mass of any object is simply the volume that the object occupies times the density of the object. For a fluid (a liquid or a gas) the

density, volume, and shape of the object can all change within the domain with time and mass can move through the domain. The conservation of mass (continuity) tells us that the mass flow rate through a tube is a constant and equal to the product of the density ρ , velocity V , and flow area A : [14]

$$\dot{m} = \rho * A * V$$

Dia. Of pipe, $D_1 = 40 \text{ mm} = 0.04 \text{ m}$

$$\text{Area, } A_1 = \pi/4 * D_1^2 = \pi/4 * (0.04)^2 = 0.001256 \text{ m}^2$$

Dia. of nozzle (Venturi) $D_2 = 20 \text{ mm} = 0.02 \text{ m}$

$$\text{Throat Area, } A_2 = \pi/4 * (0.02)^2 = 0.000314 \text{ m}^2$$

Diameter of Outlet $= D_3 = 0.04 \text{ m}$

Discharge, (given) $Q = 1.2 \text{ m}^3/\text{minute} = 1.2/60 \text{ m}^3/\text{s} = 0.02 \text{ m}^3/\text{s}$

Applying continuity equation at section (1) and (2),

$$A_1 V_1 = A_2 V_2 = Q$$

Therefore, $V_1 = Q/A_1 = 0.2/0.001256 = 15.92 \text{ m/s}$

And $V_2 = Q/A_2 = 0.2/0.000314 = 63.69 \text{ m/s}$

$$\dot{m} = \rho * A_1 * V_1 = 1000 * 0.00125 * 15.92 = 19.9 \text{ kg/sec.}$$

MODELLING PROCEDURE

CFD TOOLS: BRIEF OUTLINES

Computational fluid dynamics, usually abbreviated as ‘_CFD’, defines a branch of fluid mechanics that uses numerical methods and algorithms to predict physical fluid flows and heat transfer. Nowadays, the on-going research yields software achieving the accuracy and speed of complex simulation scenarios (turbulent and unsteady flows): hence, CFD tools can be used to calculate design mass-flow rates, pressure drops, heat transfer fluxes and fluid dynamic forces. [14]

GOVERNING EQUATIONS IN CFD

There are mainly three equations we solve in computational fluid dynamics problem. They are Continuity equation, Momentum equation (Navier Stokes equation) and Energy equation. The flow of most

National Conference on Current Trends in Engineering, Science and Technology (NACCTEST- 2018)
 Organized by GF's Godavari College of Engineering, Jalgaon
International Journal of Innovations in Engineering and Science, Special Conference Issue, 2018
 www.ijies.net

fluids may be analyzed mathematically by the use of two equations. The first, often referred to as the Continuity Equation, requires that the mass of fluid entering a fixed control volume either leaves that volume or accumulates within it. It is thus a "mass balance" requirement posed in mathematical form, and is a scalar equation. The other governing equation is the Momentum Equation, or Navier-Stokes Equation, and may be thought of as a "momentum balance". [14]

SOLVER

Pressure based segregated solver is used to solve the transport equation for mass, momentum and energy. Pressure field is obtained using SIMPLE algorithm for Pressure-Velocity coupling. [14]

BOUNDARY CONDITIONS

Air at the inlet is at room temperature and 2bar pressure. The static pressure at outlet is 1bar. All cases studied assume flow to be incompressible. Variable pressure is used as boundary condition at both the inlet and outlet Part. Attach boundaries are specified on the coincident cell face near the cells above / below the pipe. No slip wall boundary condition in conjunction with logarithmic law of wall is used.

COMPUTATIONAL APPROACH

Turbulence consists of fluctuations in the flow field in time and space. It is a complex process, mainly because it is three dimensional, unsteady and consists of many scales. It can have a significant effect on the characteristics of the flow. Turbulence occurs when the inertia forces in the fluid become significant compared to viscous forces, and is characterized by a high Reynolds Number. The k-ε model of turbulence is widely chosen for fluid flow analysis. K is the turbulence kinetic energy and is defined as the variance of the fluctuations in velocity. E is the turbulence eddy dissipation (the rate at which the velocity fluctuations dissipate).

The standard k-ε model is a semi-empirical model based on model transport equations for the turbulence kinetic energy k and its dissipation rate ε. The model transport equation for k is derived from the exact equation, while the model transport equation for ε was obtained using physical reasoning and bears little resemblance to its mathematically exact counterpart. In the derivation of the k-ε model, the assumption is that the flow is fully turbulent and the effects of molecular viscosity are negligible. The standard k-ε model is therefore valid only for fully turbulent flows.

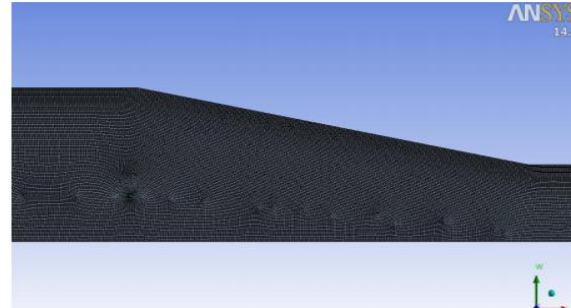

Figure-3

RESULTS AND DISCUSSION

The inlet air was assumed to enter the venturi at normal temperature and the 2bar pressure was taken and outlets 1 bar pressure. The following are results of the analysis of the venturi pipe. The results obtained from CFD analysis are correlated with analytical measured values from flow bench.

Parameters	Numerical	CFD Simulation
Mass Flow Rate kg/sec.	19.9	18.8

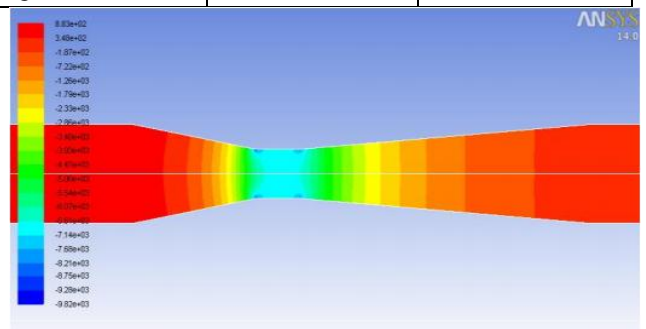

Figure-4 Pressure Contour

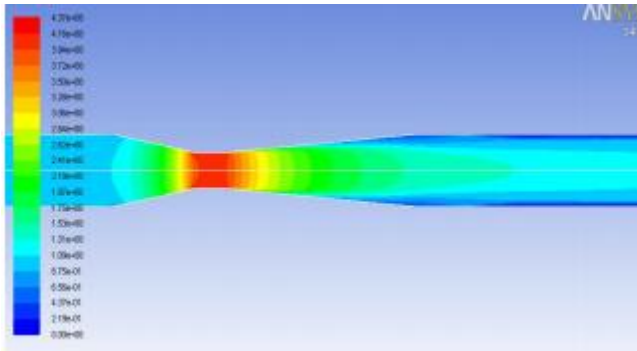

Figure-5 Velocity Contour

The above figure shows the flow pattern at the outlet of the plot of Pressure and Velocity contour for a total mass flow rate of 18.8kg/s. Figure-3 Represents the most optimal configuration considered, that shows a two dimensional view of the venturie, along with a contour plot of the static pressure (Pascal) having colour scale with red for Maximum 8.8×10^{-2} . In Figure -4 represents a two dimensional view of the venturie, along with a Velocity vectors colored by velocity magnitude (m/s) at outlet red colour shows velocity is maximum up to 4.37

CONCLUSION

The venturi is important that provides a necessary pressure drop in the carburettor device. The objective of the study was to maximize the mass flow rate. CFD and experimental results were compared for its accuracy and to develop a standard methodology for future iterations. Finally here to conclude that, the flow inside the venturie nozzle was compared with analytical calculations with CFD.

The Figure 3 and 4 shows the flow pattern at the outlet of the plot of Pressure and Velocity contour for a total mass flow rate of 18.8kg/s. Where, by flow inside the venturie nozzle for analytical calculations having result is 19kg/sec while CFD results shown 18.8kg/sec. It means analytical value is closer to the Simulated Value.

When the flow inside the venturi was analyzed, it was found that the pressure at the throat of the venturi decreased with the increase in opening of the throttle part. We have only gives you an overview of the fascinating knowledge of Venturimeter. It is regretted, however, that despite careful scrutiny of the proofs and several spelling mistake have nevertheless remained in the paper.

ACKNOWLEDGMENT

The work described in this paper was carried out as part of the Flow Programme of Venturimeter, in the Fluid Mechanics Lab and in CAD lab of BCOE Badlapur, Maharashtra, India. Their support is gratefully acknowledged. We would also like to extend my gratitude to faculty members of Department of Mechanical Engg, BCOE, Badlapur who have always encouraged and supported in doing my work.

REFERENCE:

- [1] Nikhil Tamhankar, Amar Pandhare, Ashwinkumar Joglekar, Vaibhav Bansode "Experimental and CFD analysis of flow through venturimeter to determine the coefficient of discharge", *International Journal of Latest Trends in Engineering and Technology (IJLTET)*, Vol. 3 Issue 4 March 2014, ISSN: 2278-621X
- [2] Prasanna M A, Dr V Seshadri, Yogesh Kumar K J "Numerical Analysis Of Compressible Effect In The Flow Metering By Classical Venturimeter", *International Journal Of Engineering Sciences & Research Technology*, ISSN: 2277-9655.
- [3] Laila Guessous, Radoslav Bozinoski, Russell Kouba and Donald Woodward " Combining Experiments with Numerical Simulations in the Teaching of Computational Fluid Dynamics" *Dept. of Mechanical Engineering Oakland University, Rochester, MI 48309-4478.*
- [4] Jay Kumar, Jaspreet Singh, Harsh Kansal, Gursimran Singh Narula, Prabhjot Singh "CFD Analysis of Flow through Venturi" (*IJRMET*) *International Journal of Research in Mechanical Engineering & Technology* Vol. 4, Issue 2, Spl- 2 May - October 2014, ISSN: 2249-5762 (Online) | ISSN: 2249-5770 (Print).
- [5] N. P. Gulhanel, H. S. Kadam, S. S. Kale "Analysis of Pressure and Velocity at the Throat of Self-Priming Venturi Scrubber", *Journal of Material Science and Mechanical Engineering (JMSME) Krishi Sanskriti Publications Print ISSN : 2339-9095; Online ISSN : 2393-9109; Volume 2, Number 6; April - June, 2015 pp 57 - 61*
- [6] Anshul Singhal, Mallika Parveen "Air Flow Optimization via a Venturi Type Air Restrictor" *Proceedings of the World Congress on Engineering 2013 Vol III, WCE 2013, July 3 - 5, 2013, London, U.K.*
- [7] Pranav Anil Shinde "Research and optimization of intake restrictor for Formula SAE car" *International Journal of Scientific and Research Publications, Volume 4, Issue 4, April 2014, ISSN 2250-3153*
- [8] Shashwat Sharma, Prateek Jain, Adhar Singh "A study on Optimization of Flow through Venturi of a Carburettor", *International Journal of Scientific Engineering and Technology, Volume No.3 Issue No.5, pp : 570-573, (ISSN : 2277-1581), 1 May 2014*
- [9] P. Hari Vijay, V. Subrahmanyam "CFD simulation on different geometries of venturimeter", *International Journal of Research in Engineering and Technology, eISSN: 2319-1163, pISSN: 2321-7308, Volume: 03 Issue: 07 Jul-2014*

National Conference on Current Trends in Engineering, Science and Technology (NACCTEST- 2018)
Organized by GF's Godavari College of Engineering, Jalgaon
International Journal of Innovations in Engineering and Science, Special Conference Issue, 2018
www.ijies.net

- [10] Arun R., Yogesh Kumar K J, V Seshadri "CFD Analysis of the Effect of Defects in Welding and Surface Finish on the Performance Characteristics of Venturimeter", *International Journal of Emerging Technology and Advanced Engineering*, ISSN 2250-2459, ISO 9001:2008 Certified Journal, Volume 5, Issue 6, June 2015
- [11] Chandan D. Chaudhari, Sainath A. Waghmare, and Ashish P. Kotwal "Numerical Analysis of Venturi Ducted Horizontal Axis Wind Turbine for Efficient Power Generation", *International Journal of Mechanical Engineering and Computer Applications*, Vol 1, Issue 5, September- October 2013, ISSN 2320-6349
- [13] C. R. Sanghani, D. C. Jayani, N. R. Jadvani, H. N. Dobariya, K. R. Jasoliya "Effect of Geometrical Parameters of Venturimeter on Pressure Drop", 2016 IJSRSET | Volume 2 | Issue 2 | Print ISSN : 2395-1990 | Online ISSN : 2394-4099
- [14] Arun R, Yogesh Kumar K J, V Seshadri, "Prediction of discharge coefficient of Venturimeter at low Reynolds numbers by analytical and CFD Method", *International Journal of Engineering and Technical Research (IJETR)* ISSN: 2321-0869, Volume-3, Issue-5, May 2015
- [15] Prof. Laxmikant P. Narkhede, Prof. V.H. Patil, Prof. Atul Patil, "2d CFD Simulations Of Nozzle Flow Analysis For Carburettor" *International Journal of Advances in Applied Science and Engineering (IJAEAS)* ISSN (P): 2348-1811; ISSN (E): 2348-182X Vol-1, Iss.-4, SEPTEMBER 2014, 105-111 © IIST

National Conference on Current Trends in Engineering, Science and Technology (NACCTEST- 2018)
 Organized by GF's Godavari College of Engineering, Jalgaon
International Journal of Innovations in Engineering and Science, Special Conference Issue, 2018
 www.ijies.net

Experimental and Finite Element Analysis of Bending Effect on Leaf Spring.

Bhatu Borane¹, Tushar A Koli²

¹ Student of Master of Technology,
 GF'S GCOE, Jalgaon, India, 425501

² Assistant Professor of,
 GF'S GCOE, Jalgaon, India, 425501

¹Email:- bhatuborane38@gmail.com

Abstract – The work is carried out on composite leaf spring of a commercial vehicle. The objective of this work is to carryout design and analysis of composite leaf spring with experimental design consideration and loading condition. The material of leaf spring is E-GFRC (Glass Fiber reinforced composite). The GFRC leaf springs are manufactured by hand lay-up method which were evaluated and study. The model of composite leaf spring is prepared and analyzed using ANSYS14.0 for the deflection and stresses under defined loading condition. The experimental and FEA result compared for validation. The dimension of conventional leaf spring is taken with varying thickness for evaluation of result and Static analysis is performed

Keywords- E-glass/epoxy composite, ANSYS14.0, Static Analysis.

INTRODUCTION



Fig.1- Bending effect on leaf spring

Originally Leaf spring called laminated or carriage spring, a leaf spring is a simple form of spring, commonly used for the suspension in wheeled vehicles .It is also one of the oldest forms of springing, dating back to medieval times. Sometimes referred to as a semi-elliptical spring or cart spring, it takes the form of a slender arc-shaped length of spring steel of rectangular cross-section. The center of the arc provides location for the axle, while tie holes are provided at either end for attaching to the vehicle body. For very heavy vehicles, a leaf spring can be made from several leaves stacked on top of each other in several layers, often with progressively shorter leaves. Leaf springs can serve locating and to some extent damping as well as springing functions. A leaf spring can either be attached directly to the frame at both ends or attached directly at one end, usually the front, with the other end attached through a shackle, a short swinging arm. The shackle takes up the tendency of the leaf spring to elongate when compressed and thus makes for softer springiness.

In this project, the failure in the vehicles of M.S.R.T.C. State transport buses (Ashok Leyland and Tata Motors) has been identified at workshop depot,

National Conference on Current Trends in Engineering and Technology (NACCTEST- 2018)
 Organized by GF's Godavari College of Engineering, Jalgaon
International Journal of Innovations in Engineering and Science, Special Conference Issue, 2018
 www.ijies.net

Jalgaon. As per observation, the failures may occurred due to the bending effects and may also due to suddenly applied loading, jerks, quenching cracks on the leaf spring. Leaf springs sustaining the jerks from the poor roads also subject to failure. The project aim is to study and analyze the failures using analytical, experimental and finite element analysis. For experimental purpose the strain measuring device and vibration devise can be used to acquire fluctuations over the suspension. Finite element analysis will be carried out by applying boundary conditions of calculated forces by taking in the consideration of analysis software. On further calculations we would be able to identify the major effects of stresses and strain subjected to leaf spring. The onsite study will clarify with more of the details of failures in heavy passenger carrying vehicles

METHODOLOGY

Consider a single plate fixed at one end and loaded at the other end as shown in Fig. 23.25. This plate may be used as a flat spring.

Let

t = Thickness of plate,

b = Width of plate, and

L = Length of plate or distance of the load W from the cantilever end.

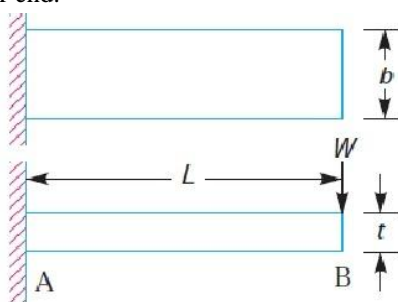

Fig. 2- leaf spring as a cantilever

We know that the maximum bending moment at the cantilever end A,

$$M = W.L$$

And section modulus,

$$Z = \frac{I}{y} = \frac{(bt^3)/12}{t/2} = \frac{1}{6} b \cdot t^2$$

∴ Bending stress in such a spring,

$$\sigma = \frac{M}{Z} = \frac{W.L}{\frac{1}{6} b \cdot t^2} = \frac{6 W.L}{b \cdot t^2}$$

We know that the maximum deflection for a cantilever with concentrated load at the free end is given by

$$\delta = \frac{W.L^3}{3EI} = \frac{W.L^3}{3E \times \frac{1}{12} b \cdot t^3} = \frac{4W.L^3}{E \cdot b \cdot t^3}$$

$$= \frac{2W.L^2}{3E \cdot b}$$

Then Maximum bending moment in the center,

$$M=W.L$$

Section modulus, $Z = \frac{b \cdot t^2}{6}$

Bending stress,

$$\sigma = \frac{M}{Z} = \frac{W.L}{\frac{b \cdot t^2}{6}} = \frac{6W.L}{b \cdot t^2}$$

DESIGN

Design Calculation for Leaf suspension spring.

Case I: On Smooth Road

Mass of bus =2792 Kg

Weight = mass* acceleration due to gravity

$$W = 2792 * 10$$

$$W= 27920 \text{ N}$$

Force = W/ no of springs

$$F = 27920/4$$

$$F = 6980 \text{ N}$$

With Passenger

No.of seat = 60

Avg. wt of passenger = 60 kg

Total load = wt. of vehicle + passenger wt

$$=2792+(60*60)$$

$$=6392 \text{ kg}$$

$$W = 6392*10 = 63920 \text{ N}$$

• **Front Spring**

• 2W =Total load/ No.spring

$$=63920/4$$

$$W =7990\text{N}$$

1) Bending stress

$$\sigma = \frac{6 W.L}{b \cdot t^2}$$

$$=6*7990*867.5^2/(12*76.7*11.11^2)$$

National Conference on Current Trends in Engineering and Technology (NACCTEST- 2018)
 Organized by GF's Godavari College of Engineering, Jalgaon
International Journal of Innovations in Engineering and Science, Special Conference Issue, 2018
 www.ijies.net

$$\sigma = 366 \text{ N/mm}^2$$

2) Deflection

$$\delta = \frac{2 \sigma \cdot l^2}{3 \sigma \cdot l} = \frac{2 * 366 * 867.5^2}{(3 * 210 * 10 * 11.11)}$$

$$\delta = 78.70 \text{ mm}$$

• **Rear Spring**

1) Bending stress

$$\sigma = \frac{6 \sigma \cdot l}{l \cdot l \cdot l^2} = \frac{6 * 7990 * 867.5}{(14 * 76.7 * 11.11^2)}$$

$$\sigma = 313.77 \text{ N/mm}^2$$

2) Deflection

$$\delta = \frac{2 \sigma \cdot l^2}{3 \sigma \cdot l} = \frac{2 * 313.77 * 867.5^2}{(3 * 210 * 10^3 * 11.11)}$$

$$\delta = 67.5 \text{ mm}$$

Table 1- analytical results of leaf spring on smooth road

Case	Bending stress (front spring) N/mm ²	Bending stress (rear spring) N/mm ²	Deflection (front spring) mm	Deflection (rear spring) mm
1	With passenger	366.70	317.77	67.5

FINITE ELEMENT ANALYSIS OF LEAF SPRING

The finite element method is a numerical technique for finding approximate solution to boundary value problem for partial differential equation. It is also referred to as finite element analysis (FEA). FEM subdivide a large problem into smaller, simpler parts called finite element. The analytical solution can be obtained from mathematical expression which is made from the different parameter which we have consider. So

the value at different location can be determined by using the mathematical expression from the structure if it is simple. If the structure is complex so it is difficult to obtain the solution from the mathematical expression in this type of cases finite element method is utilized.

Finite element method the body is divided into finite number of the smaller units. This smaller unit is known as Element. The process of dividing the body into the finite no of element is known as Discrimination. The assemblage of element then represent the original body so this all element are interconnected at the joint are known as Nodes or Nodal point.

With passenger-

Composite Material

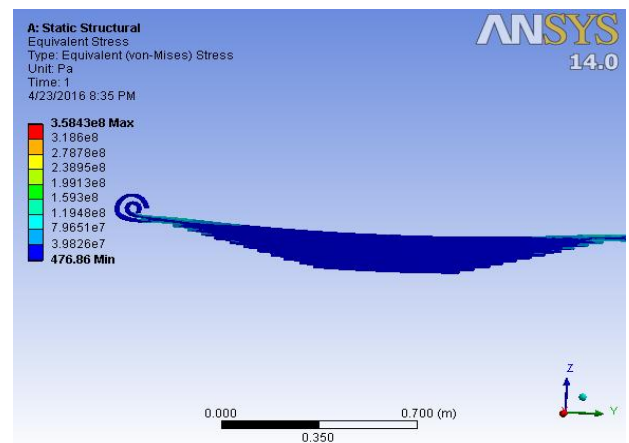

Fig. 3 -Front spring

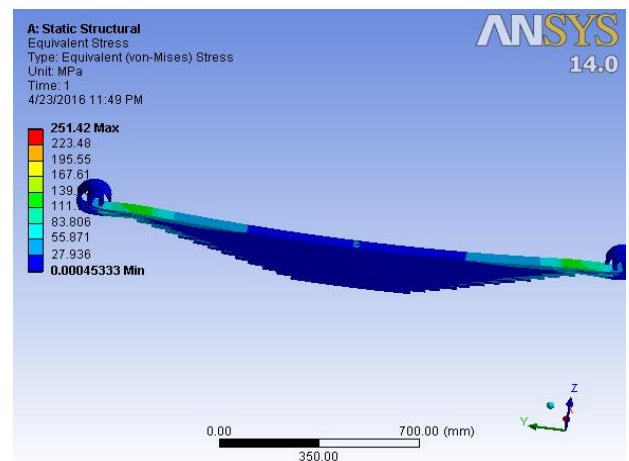

Fig. 4- Rear spring

For epoxy glass resin :

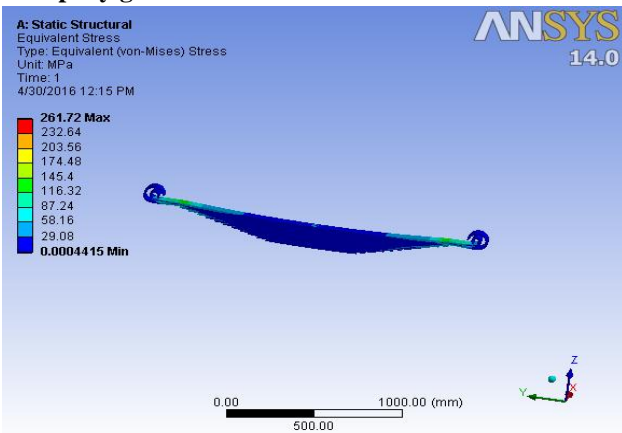

Fig 5-Front spring

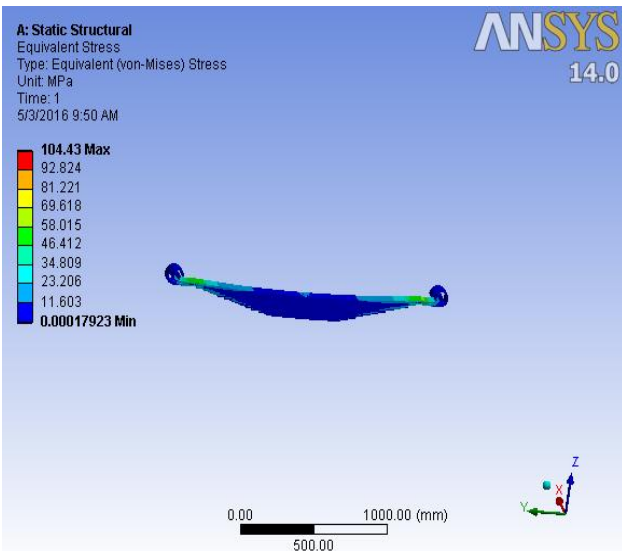

Fig. 6-Rear spring

CONCLUSION

The finite element analysis results are matches with analytical results for the loading cases calculated in chapter number 5 the complete analytical and finite element analysis is done in ANSYS 14.0 and the project shows the importance of stress analysis .From the static analysis it is found that the leaf spring for structural steel for without passenger calculated as bending stresses 156 MPa and 110 MPa for front and rear spring respectively

and for with passenger is calculated as bending stresses 358 MPa and 252 MPa respectively.

And the corresponding results for E- glass / epoxy composite leaf spring for front and rear spring with passenger is calculated with the help of ANSYS is 262 MPa and 105 MPa respectively. Among this values comparative to structural steel . The composite E-glass epoxy material leaf spring reduces the stresses in static and finite element analysis results .

E-glass epoxy composite leaf spring can be suggested for replacing the steel leaf spring from bending stresses point of view.

The graph we have to be plotted between bending stress and number of leaf spring for with passenger. Bending stresses is X coordinate and number of leaf spring on Y coordinate axis .The graph shown below.

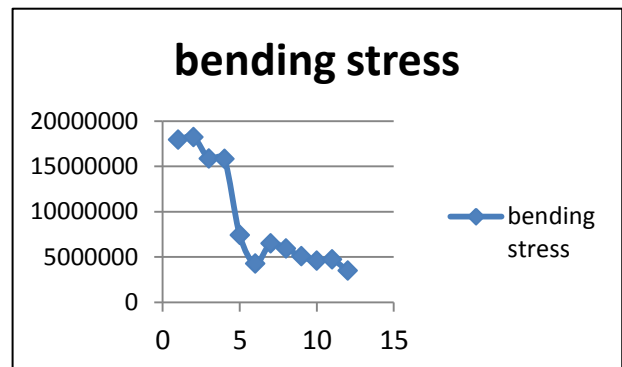

Graph 1-Bending stress Vs No.leaf spring

REFERENCES

[1] Mahmood M. Shokrieh , Davood Rezaei “ Analysis and optimization of a composite leaf spring ” *Composite Structures*, 60 (2003) 317–325.
 [2] E. Mahdi a, O.M.S. Alkoles a, A.M.S. Hamouda b, B.B. Sahari b, R. Yonus c, G. Goudah “ Light composite elliptic springs for vehicle suspension ” *Composite Structures*, 75 (2006) 24–28.
 [3] Y. N. V. Santhosh Kumar, M. Vimal Teja “ Design and Analysis of Composite Leaf Spring ” *Dept. of Mechanical Engineering, Nimra College of Engineering & Technology, Ibrahimpatnam, Vijayawada. (2012)*
 [4] Pankaj Saini, Ashish Goel, Dushyant Kumar “ Design and analysis of composite leaf spring for light vehicles ” *International Journal of Innovative Research in Science, Engineering and Technology Vol. 2, Issue 5, May 2013.*
 [5] Manas Patnaik, Narendra Yadav, Ritesh Dewangan “ Study of a Parabolic Leaf Spring by Finite Element Method & Design of

National Conference on Current Trends in Engineering and Technology (NACCTEST- 2018)
Organized by GF's Godavari College of Engineering, Jalgaon
International Journal of Innovations in Engineering and Science, Special Conference Issue, 2018
www.ijies.net

Experiments "International Journal of Modern Engineering Research
Vol.2, Issue 4, July-Aug 2012 pp-1920-1922 .

[6] Malaga. Anil Kumar , T.N.Charyulu, Ch.Ramesh " Design
Optimization Of Leaf Spring " International Journal of Engineering
Research and Applications Vol. 2, Issue 6, November- December
2012, pp.759-765.

[7] Prahalad Sawant Badkar, Prahalad Sawant Badkar " Design
Improvements of Leaf Spring of BEML Tatra 815 VVNC 8 X 8 Truck
" International Journal of Emerging Technology and Advanced
Engineering ,Volume 3, Issue 1, January 2013.

[8] H.A.Af-Qureshi "automobile leaf spring from composite
materials " Journal of materials processing technology, 118(2001).

ANNEXURE



Fig. 7-failure due to bending effect on leaf spring

National Conference on Current Trends in Engineering and Technology (NACCTEST- 2018)
 Organized by GF's Godavari College of Engineering, Jalgaon
International Journal of Innovations in Engineering and Science, Special Conference Issue, 2018
 www.ijies.net

A REVIEW ON ADVANCE INTELLIGENT PARKING BRAKE SYSTEM

Shahnawaz Khan¹, Khan Naved², Behere Kamlesh³, Deepesh Chaudhari⁴, Pinjari Salman⁵, Prof. Mayur Thakur⁶

^{1,2,3,4,5} B.E. Student,

GF'S Godavari College Of Engineering Jalgaon, India 425003

⁶ Assistant Professor

Department of Mechanical Engineering GF'S Godavari College Of Engineering Jalgaon, India 425003

¹Email:- shahnawazkhan309@gmail.com

Abstract- *“Smart parking brake” is nothing but one of the breaking systems in automobile at the time of vehicle switch-off condition. In this breaking system motorized operated one. In this project, the control unit is received the signal from the key switch. The key switch is ‘ON’ at the time of vehicle start condition. The first time clutch is applied so that the motor is rotating in forward direction for 2 sec to release the break (Already wheel is on braking condition). The key switch is ‘OFF’ the motor is rotating in reward direction for 2 sec to applying the break-parking in major cities, particularly with dense traffic, directly effects the traffic flow and people’s life. In this paper, we introduce a new smart parking system that is based on intelligent resource allocation, reservation, and pricing. The proposed system solves the current parking problems by offering guaranteed parking reservations with the lowest possible cost and searching time for drivers and the highest revenue and resource utilization for parking managers. New fair pricing policies are also proposed that can be implemented in practice.*

Keywords- *Parking brake, Automatic parking brake system, Finite element analysis (FEA), Limit switch, Electrical motor, Temperature, Torque..*

INTRODUCTION

PARKING is an expensive process in terms of either money or the time and effort spent for the “free spot chasing.” Current studies reveal that a car is parked for 95 percent of its lifetime and only on the road for the other 5 percent. If we take England in 2014 as an

example, on average a car was driven for 361 hours a year according to the British National Travel Survey yielding about 8404 hours in which a car would be parked. Now where would you park your car for these very long hours? Cruising for parking is naturally the first problem caused by the increase

of car owners globally. On average, 30 percent of traffic is caused by drivers wandering around for parking spaces. In 2006, a study in France revealed an estimation that 70 million hours were spent every year in France only in searching for parking which resulted in the loss of 700 million Euros annually . In 2011, a global parking survey by IBM states that 20 minutes is spent on average in searching for a coveted spot. With these statistics, we can assume that a great portion of global pollution and fuel waste is related to cruising for parking.

LITERATURE SURVEY

In cars, the hand brake (emergency brake, e-brake, parking brake) is a latching brake usually used to keep the car stationary, and in manual transmission vehicles, as an aid to starting the vehicle from stopped when going up an incline - with one foot on the clutch (to disengage it smoothly), the other on the accelerator (to avoid stalling from the increased torque required by the incline), a third limb is needed for the brake (to avoid rolling backwards while moving a foot from brake to accelerator). Automobile e-brakes usually consist of a cable (usually adjustable for length) directly connected

National Conference on Current Trends in Engineering and Technology (NACCTEST- 2018)
 Organized by GF's Godavari College of Engineering, Jalgaon
International Journal of Innovations in Engineering and Science, Special Conference Issue, 2018
 www.ijies.net

to the brake mechanism on one end and to some type of mechanism that can be actuated by the driver on the other end. The mechanism is often a hand-operated lever (hence the *hand brake* name), on the floor on either side of the driver, or a pull handle located below and near the steering wheel column, or a (foot-operated) pedal located far apart from the other pedals.

N1 = Motor speed in RPM---40 RPM

N2 = Output speed

D2 = Diameter of the roller gear wheel = 88 mm

D1 = Diameter of the motor gear wheel = 35 mm

$$\therefore N2 = (D1/D2) \times N1$$

$$= (35 / 88) \times 40 = 16 \text{ rpm}$$

DESIGN AND DRAWING

Bearing No. 6202:-

Outer Diameter of Bearing (D) = 35 mm

Thickness of Bearing (B) = 12 mm

Inner Diameter of the Bearing (d) = 15 mm

r₁ = Corner radii on shaft and housing

r₁ = 1 (From design data book)

Maximum Speed = 14,000 rpm (From design data book)

$$\text{Mean Diameter } (d_m) = (D + d) / 2$$

$$= (35 + 15) / 2$$

$$d_m = 25 \text{ mm}$$

WAHL STRESS FACTOR

$$K_s = \{ (4C - 1) / (4C - 4) \} + (0.615 / C)$$

$$C = 2.3$$

$$K_s = 1.85$$

SPEEDS IN GEAR BOX:

Measured Specifications:

$$N1/N2 = D2/D1$$

Where,

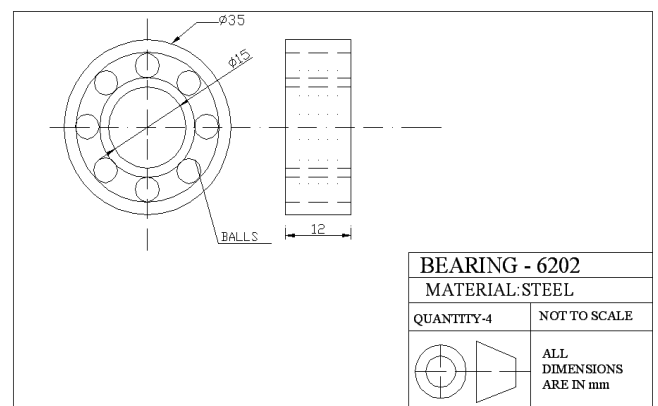
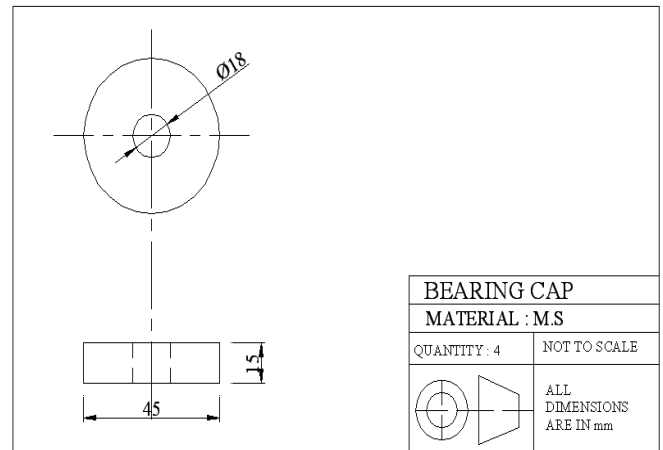

BATTERY

Current carrying capacity of 12 V battery = 7.5 AH

For batteries the current = 12 V / 7.5 AH

National Conference on Current Trends in Engineering and Technology (NACCTEST- 2018)
Organized by GF's Godavari College of Engineering, Jalgaon
International Journal of Innovations in Engineering and Science, Special Conference Issue, 2018
www.ijies.net

The battery discharges at a rate of 0.75.

It will withstand for 20 hours.

CONCLUSION

The fabrication of Automatic Hand Break Release was successfully completed as per the specification. The trial performance of this device provides to be successful, with ease of operation and safety, hence the results have given a clear indication of its commercial viability. The cost analysis has shown its economic feasibility and we are under the impression that it can be further reduced, when produced on a mass scale.

ACKNOWLEDGEMENT

We take this opportunity to express our profound gratitude to our esteemed guide **Prof. Mayur P Thakur** for his excellent guidance and suggestions.

We are extremely fortunate to be involved in an exciting and challenging review paper. This paper has improved our thinking and understanding capability. We are also thankful to **Dr. V. H. Patil**, H.O.D, Mechanical Engineering Department of Godavari College of Engineering, Jalgaon for his constant support and encouragement. We also extend our sincere thanks to all faculty members of Mechanical Engineering department for making this paper as successful one, for their valuable advice in every stage and also giving us absolute working environment where we unleashed our potential. We would like to convey our heartiest gratitude to our parents who deserve more recognition than we could ever acknowledge.

REFERENCES

- [1] A H Rozainia, M R Ishak, A R Abu Bakar. "Performance of a fully mechanical parking brake system for passenger cars", 2nd International Conference on Mechanical Engineering Research (ICMER 2013), IOP Publishing, IOP conference. Series: Material science and engineering 50(2013) 012006.
- [2] Allen, R., Szostak, H., Rosenthal, T., Klyde, D., Owens, K., 1991. Characteristics influencing ground vehicle lateral/directional dynamic stability. Society of Automotive Engineers (SAE) Technical Paper No. 910234.

[3] Annesse, J., 2007. Tragic turn for teen in freak mishap. *Staten Island Advance* 30 (August). American National Standards Institute (ANSI), 2004a. American National Standard for Golf Cars-Safety and Performance Specifications Z130.1-2004.

[4] Wang N. Electric brake actuator. 2002. US patent app. 10/216,078.

[5] Jung HM, Park CH, Jeon JW, Yeo H. Development of electric parking brake system. In: *Proceedings of the KSAE autumn conference, Deoksan, Korea; 2007.p. 962-7.*

[6] Hyun D, Kim IS, Seo H. Study on a dynamic braking algorithm for an electronic parking brake. In: *Proceedings of the KSAE autumn conference, Deoksan, Korea; 2007. p. 950-5.*

[7] Godlewsky G, Maur T, Keller M, Leiter R, Kinder R, Poertzgen G. Electrically actuatable vehicle brake and method for controlling an electrically actuatable vehicle brake. 2005. US patent app. 11/126,902.

Double Axis Welding Machine Attachment.

Umesh Patil¹, Tushar A Koli²

¹ Student of Master of Technology,
 GF'S GCOE, Jalgaon, India, 425001

² Assistant Professor of,
 GF'S GCOE, Jalgaon, India, 425001
¹Email:- umeshnpatil.99@gmail.com

Abstract – In our research “Automated Double Axis Welding Machine” is beings with an introduction to welding the various components automatically. Two motors for controlling and relay are provided in this attachment. One motor is for the up and down movement, another one for arm lifting and one for the rotary motion. The aim of the project is to manufacture a welding machine which simplifies the work and improve the accuracy. The working principle of this machine is different other that of other welding machine. The working principle is very easy and at the same time production time is very much reduced. This machine is best suitable for mass production. The working principle is very easy and at the same time, production time is very much reduced. This machine is best suitable for mass production.

Keywords- Welding, Mechanism, Robots etc

INTRODUCTION

Welding is a process of joining similar metals by the application of heat. Welding can be done with or without the application of pressure. While welding, the edges of metal pieces are either melted or brought to plastic condition. Welding can be done with the addition off filler materials or without it welding is used of making permanent joints. It is used in the manufacture of automobile bodies, aircraft frames, railways wagons, machine frames, structural work, tanks, furniture, boilers, general repair work and ship building, At most in all metal working industries welding is used.

METHODOLOGY

DESIGN OF BALL BEARING

Bearing No. 6202

Outer Diameter of Bearing (D) =35 mm

Thickness of Bearing (B) =12 mm

Inner Diameter of the Bearing (d)=15 mm

r_1 =Corner radii on shaft and housing

r_1 =1(From design data book)

Maximum Speed=14,000 rpm (From design data book)

Mean Diameter (d_m) = (D + d) / 2 = (35 + 15) / 2

$$d_m = 25 \text{ mm}$$

Spring index (C)=(D / d) = (35 / 15) = 2.3

WAHL STRESS FACTOR

$K_s = [(4C-1) / (4C-4)] + (0.65/C)$ {C=2.3}

$$K_s = 1.85$$

CHAIN DRIVES

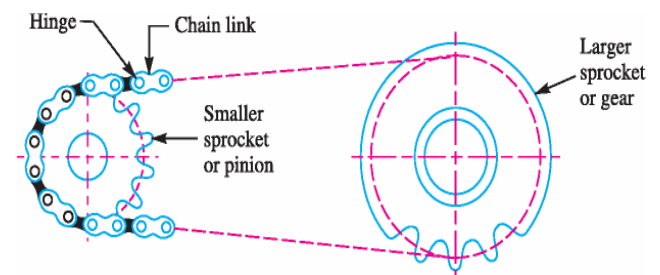

Relation b/w pitch and pitch circle diameter

$$\text{Pitch of chain } p = d \sin(\Theta/2)$$

$$\Theta = 360^\circ/T$$

$$P = D \sin(180/T)$$

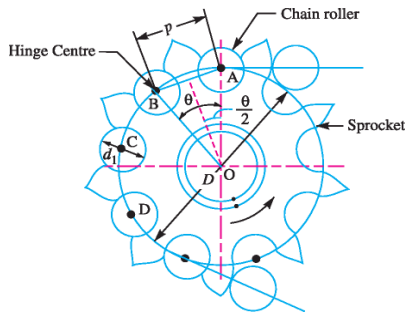

$$\text{Sprocket outside diameter } D_o = D + 0.8d_1$$

D1 = dia. of chain roles

$$\text{V.R.} = N_1/N_2 = T_2/T_1$$

N_1 & T_1 for smallest sprocket

N_2 & T_2 for large sprocket

$$\text{Avg. velocity } V = \pi DN/60$$

$$= \text{TPN}/60$$

- Bush rolles chain
- Factor of safety for chain drives

$$\text{F.S.} = W_b / W$$

Tangential driving force acting on the chain

$$F_t = P/V$$

$$\text{Centrifugal tension } f_c = mV^2$$

Tension in the chain drive due to sagging

$$f_s = k m g x$$

m=mass of chain in kg / m length

$$K = 2 \text{ to } 2.6 \quad (\text{or}) \quad \Theta < 40^\circ$$

$$= 1 \text{ to } 1.5 \quad \Theta > 40^\circ$$

Power transmitted by chains on the basis of bearing load

$$P = (W b x V) / (N x K_s)$$

n = factor of safety

$$K_s = K_1 \times K_2 \times K_3$$

On the basis of bearing sticks

$$P = (f_b \times A \times V) / K_s$$

1. Load factor $K_1 = 1.5$ for heavy shock loads
2. Lubrication factor $K_2 = 1.5$ for periodic lubrication
3. Rating factor $K_3 = 1$ for haves per day.

Number of teeth on the smaller (or) driving sprocket (or) pinion

d = pitch circle dia. for smaller,

$$\square \square \square = \frac{\pi d N \cos/2}{60}$$

No. of teeth on sprocket $T_1 = 29$

Variation of speed = 1.6 %.

For 17 teeth V.R = 2.48

$$\text{V.R.} = T_2/T_1 = 2.48,$$

$$T_2 = 2.48 \times 29 = 72 \text{ teeth.}$$

Principal dimension of tooth profile

1. Tooth flank radices $r_e = 0.008 d_1 (T^2 + 180) \text{ mar}$

$$= 0.12 d_1 (T+2) \text{ min}$$

D1 =Roller diameter, T =No. of teeth

2. Roller seating radies (R_1)

$$R_1 = 0.505 d_1 + 0.069 3\sqrt{d_1} = \mathbf{0.505 d_1}$$

3. Roller seating angle

$$\sigma = 140^\circ - (90^\circ/T)$$

$$= 120^\circ - (90^\circ/T)$$

4. Tooth height above pitch polygon (h_a)

$$H_a = 0.625 p - 0.5d_1 + (90^\circ/T)$$

5. Pitch circle diameter= $0.5 (p - d_1)$

$$D = P/\text{Sin}(180) = P \text{ Cosec}(180/T)$$

Length of chain drive

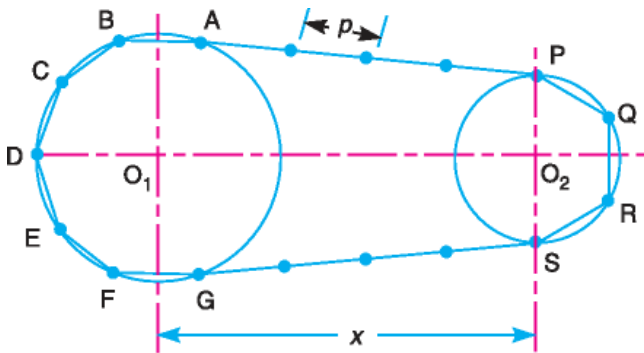

$$L = \pi(r_1 + r_2) + 2x + \frac{(r_1 - r_2)^2}{x}$$

Where $x = 30$ to 50 times pitch

At ISO chain number 06B pitch=9.525mm

$$x = 40 * 9.525 = 381\text{mm}$$

SPROCKET AND CHAIN DRIVE:

This is a cycle chain sprocket. The chain sprocket is coupled with another generator shaft. The chain converts rotational power to pulling power, or pulling power to rotational power, by engaging with the sprocket. The sprocket looks like a gear but differs in three important ways:

1. Sprockets have many engaging teeth; gears usually have only one or two.
2. The teeth of a gear touch and slip against each other; there is basically no slippage in a sprocket.
3. The shape of the teeth is different in gears and sprockets.



Fig:- Types of Sprockets

Engagement with Sprockets:

though chains are sometimes pushed and pulled at either end by cylinders, chains are usually driven by wrapping them on sprockets. In the following section, we explain the relation between sprockets and chains when power is transmitted by sprockets.

1. **Back tension:**-First, let us explain the relationship between flat belts and pulleys. Figure 2.5 shows a relation of a flat belt drive. The circle at the top is a pulley, and the belt hangs down from each side. When the pulley is fixed and the left side of the belt is loaded with tension (T_0), the force needed to pull the belt down to the right side will be: $T_1 = T_0 e^{\mu u}$

For example, $T_0 = 100$ N: the coefficient of friction between the belt and pulley, $\mu = 0.3$; the wrap angle $u = \frac{1}{4}$ (180).

$$T_1 = T_0 32.566 = 256.6 \text{ N}$$

In brief, when you use a flat belt in this situation, you can get 256.6 N of drive power only when there is 100 N of back tension.

For a elements without teeth such as flat belts or ropes, the way to get more drive power is to increase the coefficient of friction or wrapping angle. If a substance, like grease or oil, which decreases the coefficient of friction, gets onto the contact surface, the belt cannot deliver the required tension. In the chain's case, sprocket teeth hold the chain roller. If the sprocket tooth configuration is square, as in Figure 2.6, the direction of the tooth's reactive force is opposite the chain's tension, and only one tooth will receive all the chain's tension. Therefore, the chain will work without back tension.

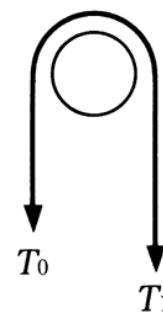

Fig. Flat belt Drive

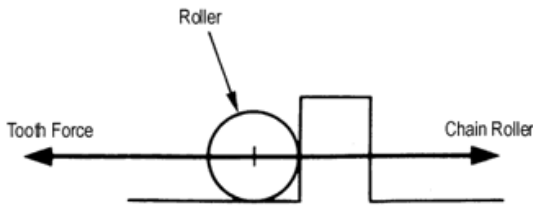

Fig. Simplified Roller And Tooth forces

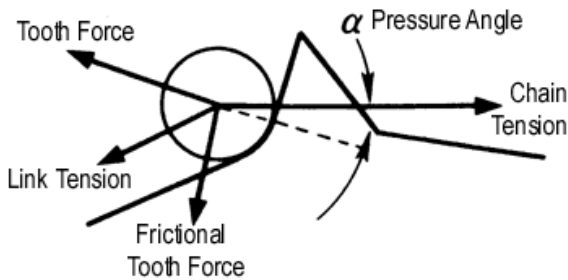

Fig:The balance of forces around the roller

But actually, sprocket teeth need some inclination so that the teeth can engage and slip off of the roller. The balances of forces that exist around the roller are shown in Figure 2.7, and it is easy to calculate the required back tension.

For example, assume a coefficient of friction $\mu = 0$, and you can calculate the back tension (T_k) that is needed at sprocket tooth number k with this formula:

$$T_k = T_0 \frac{3 \sin \phi}{k-1 \sin(\phi + 2b)}$$

Where:

T_k = back tension at tooth k

T_0 = chain tension

ϕ = sprocket minimum pressure angle $17.64/N(\text{°})$

N = number of teeth

$2b$ = sprocket tooth angle $(360/N)$

k = the number of engaged teeth (angle of wrap $3N/360$); round down to the nearest whole number

to be safe

By this formula, if the chain is wrapped halfway around the sprocket, the back tension at sprocket tooth number six is only 0.96 N. This is 1 percent of the amount of a flat belt. Using chains and sprockets, the required back tension is much lower than a flat belt.

Now let's compare chains and sprockets with a toothed-belt back tension. Although in toothed belts the allowable tension can differ with the number of pulley teeth and the revolutions per minute (rpm), the general recommendation is to use 1/3.5 of the allowable tension as the back tension (F). This is shown in below Figure 2.8. Therefore, our 257 N force will require $257/3.5 = 73$ N of back tension.

Both toothed belts and chains engage by means of teeth, but chain's back tension is only 1/75 that of toothed belts.

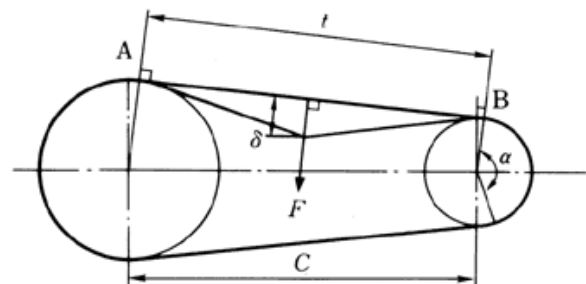

Fig. 2.8 Back tension on a toothed belt

Chain wear and jumping sprocket teeth

The key factor causing chain to jump sprocket teeth is chain wear elongation (see Basics Section 2.2.4). Because of wear elongation, the chain creeps up on the sprocket teeth until it starts jumping sprocket teeth and can no longer engage with the sprocket. Figure 2.9 shows sprocket tooth shape and positions of engagement. Figure 2.10 shows the engagement of a sprocket with an elongated chain.

In Figure there are three sections on the sprocket tooth face:

a: Bottom curve of tooth, where the roller falls into place;

- b: Working curve, where the roller and the sprocket are working together;
- c: Where the tooth can guide the roller but can't transmit tension. If the roller, which should transmit tension, only engages with C, it causes jumped sprocket teeth.

The chain's wear elongation limit varies according to the number of sprocket teeth and their shape, as shown in Figure. Upon calculation, we see that sprockets with large numbers of teeth are very limited in stretch percentage. Smaller sprockets are limited by other harmful effects, such as high vibration and decreasing strength; therefore, in the case of less than 60 teeth, the stretch limit ratio is limited to 1.5 percent (in transmission chain).

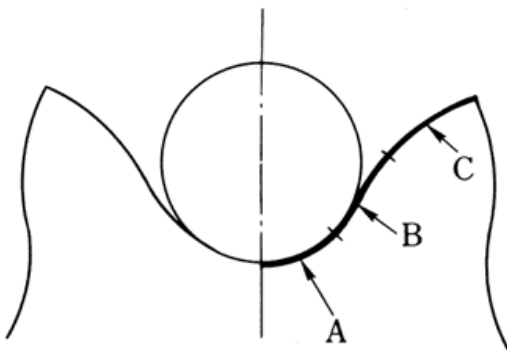

Fig.2.9: Sprocket Tooth shape and positions of Engagement

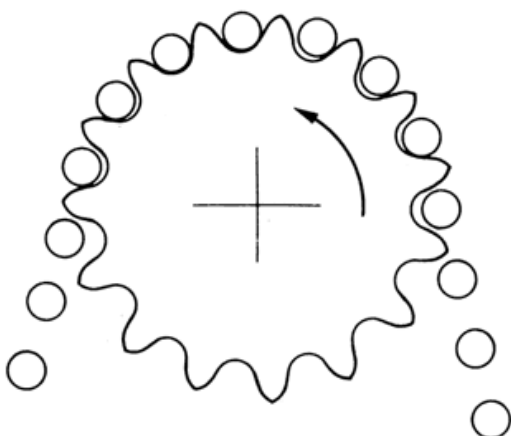

Figure2.10:-The engagement between a Sprocket and elongated chain

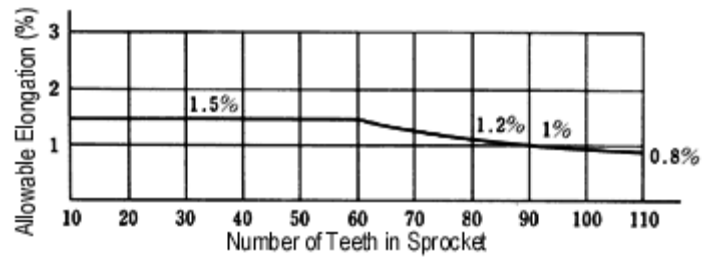

Fig.2.11: Elongation versus the number of sprocket teeth

In conveyor chains, in which the number of working teeth in sprockets is less than transmission chains, the stretch ratio is limited to 2 percent. Large pitch conveyor chains use a straight line in place of curve B in the sprocket tooth face.

A chain is a reliable machine component, which transmits power by means of tensile forces, and is used primarily for power transmission and conveyance systems. The function and uses of chain are similar to a belt. There are many kinds of chain. It is convenient to sort types of chain by either material of composition or method of construction.

We can sort chains into five types:

- Cast iron chain.
- Cast steel chain.
- Forged chain.
- Steel chain.
- Plastic chain.

Demand for the first three chain types is now decreasing; they are only used in some special situations. For example, cast iron chain is part of water-treatment equipment; forged chain is used in overhead conveyors for automobile factories. In this paper, we are going to focus on the latter two: "steel chain," especially the type called "roller chain," which makes up the largest share of chains being produced, and "plastic chain." For the most part, we will refer to "roller chain" simply as "chain."

Basic Structure of Power Transmission Chain

A typical configuration for RS60-type chain is shown in Figure

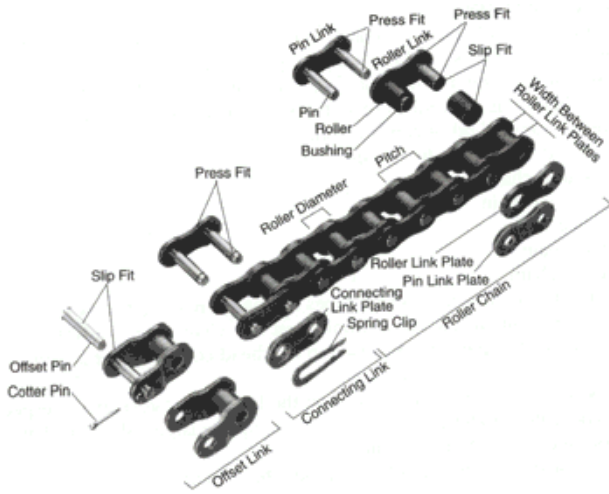

Fig1.1: The basic components of chain

Connecting Link:-This is the ordinary type of connecting link. The pin and link plate are slip fit in the connecting link for ease of assembly. This type of connecting link is 20 percent lower in fatigue strength than the chain itself. There are also some special connecting links which have the same strength as the chain itself.

Tap Fit Connecting Link :-In this link, the pin and the tap fit connecting link plate are press fit. It has fatigue strength almost equal to that of the chain itself.

Offset link:-An offset link is used when an odd number of chain links is required. It is 35 percent lower in fatigue strength than the chain itself. The pin and two plates are slip fit. There is also a two-pitch offset link available that has fatigue strength as great as the chain itself

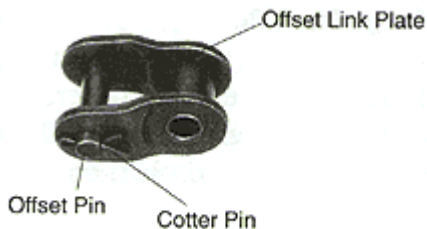

Fig.1.3 :-Offset link

FABRICATION OF THE UNIT

The fabrication of unit consist of almost all the standard welding processes such as welding, fitting, assembling etc.

The unit necessitates the manufacturing of following parts.

- Vertical Movable arm
- Horizontal Moving arm
- Vice
- Holding Tool
- Relay coil
- Frame stand

The components manufactured in process involved in manufacturing in detail in the report else. The manufacturing and assembly of this arrangement is made as rigid as possible.

VERTICAL MOVABLE BED (UPPER ARM):Upper arm is also called as movable Bed. As the arm can move up and down, it is called as movable arm. The upper arm is connected to the frame stand. The motor is fixed on this moving bed with suitable bolt and nut arrangement.

HORIZONTAL MOVING BED (LOWER ARM):Horizontal moving bed also called as Lower arm. As the arm can move linear it is called as movable arm. The lower arm is connected to the frame stand. The vice is fixed on this moving bed with suitable bolt and nut arrangement.

SUPPORTING JAW: It is found on the either end of the vice which is fixed on the base plate by the help of bolt and nut. Its supports the work piece can be moved of max angle fixing the jaw the work piece to be cut is placed to an angle whose edge. Handle is rotated the self tilting jaw, when approaches the other side of the work piece automatically moves to angle and grips the work piece.

FRAME STAND

It is made up of mild steel. This is the base of the above all components of the machine.

DC MOTOR:

PRINCIPLE OF OPERATION:

The basic principle of motor action lies in a simple sketch. The working principle tells that, when a current carrying conductor is placed in a magnetic field, a force is produced to move the conductor away from the magnetic field.

Movement of conductor



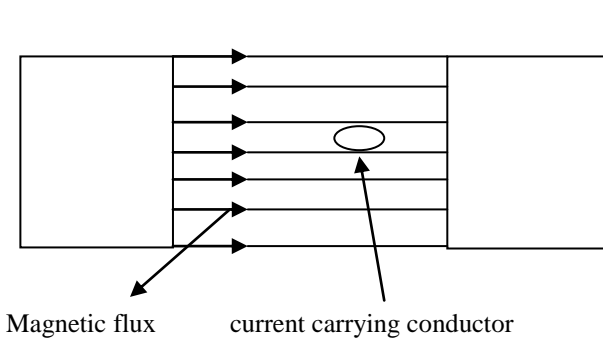

The force given by the equation,

$$F = B I L \text{ Newton}$$

Where,

B = Flux density in WB/sq.m

I = Current through the conductor

L = Length of the conductor

Let us consider a single turn coil. The coil side A will be forced to move downward, where as the coil side "B" will be forced to move upward. Due to this movement now the coil is made to rotate. Since the coil is arranged into rotate. Since the coil is arranged in the armature when it rotates in emf is induced in the coil and that emf which is induced in the coil is in opposite to supply emf. Therefore we can call the emf induced as back emf (B-emf). Hence when motor runs normally the supply emf (V) is equal to (B-emf).

Therefore

$$V = V_b + V_a \text{ (or) } V = V_b + I_a R_a \text{ (Since } V = IR)$$

Multiplying both sides by I_a ,

$$\text{Therefore } V I_a = V_b I_a + (I_a \times I_a) R_a$$

Where, $V I_a$ is the electrical equivalent of the mechanical power developed in the motor and $(I_a \times I_a) R_a$ is armature drop.

This process that motor converts electrical energy mechanical energy where $(I_a \times I_a) R_a$ is the copper loss which is to be neglected.

CONSTRUCTION AND WORKING PRINCIPLE

Two pieces are welded together due to the pressure exerted by the two materials, which are connected to the lower and upper arms, where the upper arm is movable and the lower arm is also movable.

BLOCK DIAGRAM

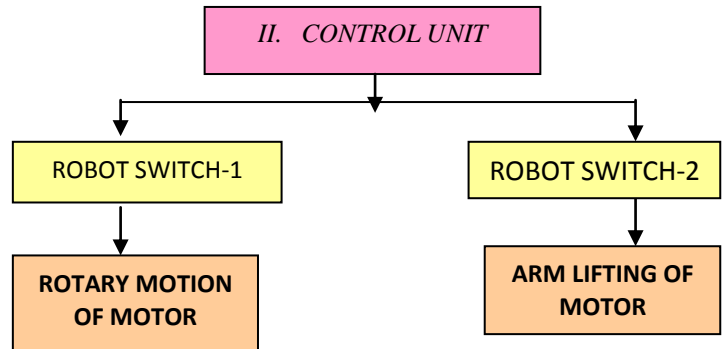

WORKING PRINCIPLE

The assembly unit consists of a base block, cylinders, rack and pinion, base plate, tie rods, driver relay and gripper. Motor 1 is mounted on the base block with sliding assembly connected with tie rods. The vertical motor is mounted vertically over the base plate to increase the height with a block and endplate provided at the end. The horizontal motor is mounted on the block of the vertical motor horizontally to increase length of the arm with a block and end plate provided at the end position.

The experimental setup consist of three motor s, all are of sliding type. The motor 1 is used to actuate rack and pinion assembly, rod of motor 1 is connected to rack, which is meshed with the pinion. By operating the motor 1, rack and pinion turns the whole assembly for 180° . By varying the length of the rack the turning angle can be altered. Vertical motor or motor 2 is used to increase the height of the setup. The height is limited to rod length

CONCLUSION

We feel very happy and proud in fabricating this project "double axis welding machine attachment". This machine is used for welding all kinds of metals. By doing this project we are acquire lot of experience and knowledge about various assembling, regarding the manufacture of this project. Due to this project we have gained a lot of knowledge about fabrication of various parts, the allowances, the tolerances, limits and fits, sequence of operation to be performed. We are able to think about best method of performing the work and about "How a high degree of precision work is done". This unit is driven by 12V D C motor. This enables the slide to get the reciprocating motion having a stroke length near about of 300mm. we are lifting the arm using 12 V DC motor it slide and lift the arm. welding gun is attached to tip of arm for operating the welding at high temperture.we are

National Conference on Current Trends in Engineering, Science and Technology (NACCTEST- 2018)
Organized by GF's Godavari College of Engineering, Jalgaon
International Journal of Innovations in Engineering and Science, Special Conference Issue, 2018
www.ijies.net

controlling the whole mechanism on AC control unit by providing six push on button on control unit.

REFERENCES

- [1] *"History of the Automobile"*. Gmcanada.com. Retrieved 2011-01-09.
- [2] A B Chocoholic, S. E. (1988) *"The development of a differential for the improvement of traction control"*
- [3] Bonnick, Allan. (2001) *"Automotive Computer Controlled Systems"* p. 22
- [4] Bonnick, Allan. (2008). *"Automotive Science and Mathematics"* p. 123
- [5] Provatidis, Christopher, G. (2003). "A critical presentation of Tsiriggakis' gearless differential". *Mobility & Vehicles Mechanics* 29 (4): 25–46; also: http://users.ntua.gr/cprovat/index_en.htm
- [6] *"The Complete Story of Porsche 911"*. Autozine.org. Retrieved 2011-01-09.
- [7] Wright, M T. (2005). "The Antikythera Mechanism and the early history of the Moon Phase Display". *Antiquarian Horology* 29 (3 (March 2006)): 319–329.
- [8] *"ZF Press release"*. Zf.com. Retrieved 2011-01-09.

Performance Improvement of Vortex Tube, By Varying Inside Surface Roughness of Cylindrical Hot Tubes

Nitin Vijay Galwade¹, Prof. Tushar A Koli², Dr. V H Patil³

¹PG Student,

Godavari College of Engineering, Jalgaon

²Assistant Professor,

Godavari College of Engineering, Jalgaon

³Associate Professor,

Godavari College of Engineering Jalgaon

¹Email:- nitingalwade@gmail.com

Abstract – Refrigeration plays an important role in developing countries, primarily for the preservation of food, medicine, and for air conditioning. Conventional refrigeration systems are using Freon as refrigerant. As they are the main cause for depleting ozone layer, extensive research work is going on alternate refrigeration systems. Vortex tube is a non-conventional cooling device, having no moving parts which will produce cold air and hot air from the source of compressed air without affecting the environment. When a high pressure air is tangentially injected into vortex chamber a strong vortex flow will be created which will be split into two air streams. It can be used for any type of spot cooling or heating application. In this paper, counter flow vortex tube with different surface roughness hot tubes performance is compared. It was found that the vortex tube with a surface roughness of $R_a = 6.264 \mu\text{m}$ surpassed the hot tubes with a surface roughness of $R_a = 4.510 \mu\text{m}$ & $R_a = 3.133 \mu\text{m}$ by 6% to 26% and 16% to 52% in COP respectively. The COP of the vortex tube increases with the increase of inside surface roughness of hot tube

A vortex tube contains the different main parts vortex chamber inlet nozzle and cold terminal orifice, hot control valve and orifice. It works in such a way that the fluid enters in the tube circulates about an axis which is called as vortex. And that rotation creates a vortex from the compressed air and separates that flow in two in air

streams hot and cold. From its Centre the super-cooled air is passed and which is being delivered through cold end port. The surface finish of nozzle and the tube i.e. hot end takes an important role in performance of Vortex Tube. In this paper it is observed that the vortex tube with major values of surface roughness of cylindrical hot tubes are used to increase the efficiency of vortex tube. It results in COP of vortex tube.

Keywords- Vortex chamber, Roughness value of cylindrical hot tubes, COP of the system, Efficiency of tube.

INTRODUCTION

The vortex tube is a thermal static tube that separates compressed gas flow to two streams; one stream colder than the inlet flow while the other stream is hotter than the inlet flow. The vortex tube does not have any moving parts and the separation occurs due to vortex flow generation without requiring any external mechanical work or heat transfer. The vortex tube was first discovered by Ranque [1, 2] who was granted a French patent for the device in 1932, and a United States patent in 1934. Ranque encountered the vortex tube phenomenon while he was experimentally working with vortex tube pump in 1928. In 1945, Rudolf Hilsch [3] conducted an experiment on vortex tube that focused on

National Conference on Current Trends in Engineering, Science and Technology (NACCTEST- 2018)
 Organized by GF's Godavari College of Engineering, Jalgaon
 International Journal of Innovations in Engineering and Science, Special Conference Issue, 2018
 www.ijies.net

the thermal performance with different inlet pressure and different geometrical parameters. In the recent years it was known that vortex tube is a low cost and an effective solution for many spot cooling problems. The separation mechanism inside the vortex tube remains until today not completely understood [4]. The ability to obtain either hot or cold flow streams using compressed gas, allowed the use of vortex tube in many engineering applications such as cooling of electronics, cooling of food, cooling of firemen's suit and cooling of machinery during operation. Despite its small capacity, the Ranque-Hilsch vortex tube (RHVT) is very useful for certain thermal management applications because of its simplicity, high durability, compactness, light weight, robustness, reliability, low maintenance cost and safety [5]. The RHVT can be classified into two types [6]: (1) the counter-flow RHVT and (2) the uni-flow RHVT. In the counter flow RHVT type the cold flow move in the opposite direction with respect to the hot stream, while in the uni-flow type, the hot and cold streams flow in the same direction. In general, the counter-flow RHVT is recommended over the uni-flow RHVT for its efficient energy separation [6]. Vortex tube is covered extensively in literatures through experimental and numerical analysis. The experimental work of Nimbalkar and Muller [7] indicated that there is an optimum diameter of the cold end orifice for achieving maximum energy separation. Also, the results [7] showed that the maximum value of energy separation was always reachable at a 60 % cold fraction irrespective of the orifice diameter and the inlet pressure. The optimum diameter to the length ratio of the hot side was investigated by Dincer et al. [8, 9]. The vortex tube performance was investigated for three different working gases: air, oxygen and nitrogen and the results were reported using streakline visualizations in a vortex tube made of Perspex [10]. Aydin and Baki [10] and Hamdan et al. [11] indicated that inlet pressure and cold mass fraction were the most important operating parameters. Hamdan et al. [11] in their experimental work studied effect of several operating and geometrical parameters on the thermal performance of the vortex tube, where the location effect of the vortex stopper, the inlet gas pressure, the number of vortex generator inlet nozzles and the insulation were covered during the study. Eiamsa-ard [12] investigated the effect multiple inlet nozzles, the cold orifice diameter ratios and inlet pressure. Eiamsa-ard [12] reported that energy separation enhanced as number of nozzle increased to

four nozzles. The increase in the nozzle number and the supply pressure leads to the rise of the swirl/vortex intensity and thus the energy separation in the tube.

METHODOLOGY

WORKING PRINCIPLE

Compressed air at high pressure enters the vortex tube through tangential nozzle where the flow gets accelerated. Due to tangential entry, the air has high velocity and rotates at very high speed. Thus the air has whirling or vortex motion in vortex chamber, which subsequently spiral down the tube to right side (depends on the direction of spiral). The central core of the air is reversed by means of a conical valve, which control the pressure in the system. The end of the cold pipe, which built up with the vortex chamber, is fitted with a washer that has the half the diameter of the pipe. Washers with different diameter are also used to adjust the system. The reversed air at low temperature moving through the washer to the cold section. Thus cold air is produced at the left side of vortex chamber. Hot air is produced at the right side through the conical valve.

DESIGN AND CONSTRUCTION DETAILS

The design details of vortex tube: Diameter of vortex tube $D = 20$ mm; Length of vortex tube $L = 135$ mm. Diameter of orifice $D_o = 6$ mm, Diameter of nozzle $D_{RN} R = 5$ mm, No of nozzle = 1, Material = Mild steel, Inlet pressure = 4 - 8 bar, Surface roughness values of hot tube 3.133, 4.510 and 6.264 μm .

EXPERIMENTAL SET UP

A two-dimensional cross section of used vortex tube is shown in Fig. 1a. Room temperature compressed air is used as working fluid at different inlet pressure values. The compressed air enters in the middle of the vortex tube to a chamber that distributes the air into multiple inlet nozzles that promote vortex flow generation within the vortex generator, Fig. 1b. The vortex flow get separated to two outlets where hot air leaves from the outer perimeter of the vortex while cold air leaves from the center of vortex at the opposite direction as shown in Fig. 1a. A vortex stopper shown in Fig. 1c is used to stop the flow from rotating while leaving the hot side of the

National Conference on Current Trends in Engineering, Science and Technology (NACCTEST- 2018)
Organized by GF's Godavari College of Engineering, Jalgaon
International Journal of Innovations in Engineering and Science, Special Conference Issue, 2018
www.ijies.net

vortex tube. The detail design and dimension of the vortex generator is shown in Table 1. The Heat Mass Transfer schematic diagram of the experimental setup is shown in Fig. 2. The compressed air is provided through compressor storage tank to assure uniform pressure with minimum variation. The storage tank size is 1 m³ and the system is kept running for half an hour before conducting the test to allow system to warm up and tank temperature to stabilize. The compressor maximum rated pressure is 12 bars, even though all runs where for inlet pressure of 5 bars or below. The compressed gas passed through a dehumidifier, oil filter and particle separation filter to assure the use of clean dry air. The air is expanded in the vortex tube chamber and separated into hot air stream and cold air stream. The cold stream in the central region flows out of the tube through the central orifice nearer to the inlet nozzle, while the hot stream in the outer annulus leaves the tube through other outlet far from the inlet. The flow rate of the inlet air is regulated through flow Rota-meter valve while the pressure is controlled using a pressure controller that is attached on the compressor tank outlet. All experimental runs are conducted in similar manner following a specific procedure, where the compressor runs for half hour to allow reaching steady state temperature of inlet compressed air. The pressure inside the pressurized tank is kept higher than 6 bar while a check valve is used to assure continuous uniform inlet pressure of 5 bars to the experiment. Incase pressure drop inside the tank below 6 bars the test is hold till pressure is build up inside the air tank. A short plastic pipe connection is used at the cold/hot outlet to allow fixing the thermocouples and to reduce the effect of heat transfer. The temperatures are logged in over a period of time using portable handheld data logger with eight data inputs. A Borden tube pressure gage with 0.2bar uncertainty is used to measure the inlet pressure.

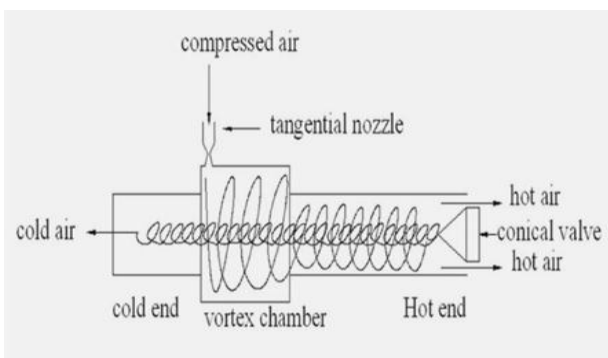

Fig1.2d. View of Vortex Tube

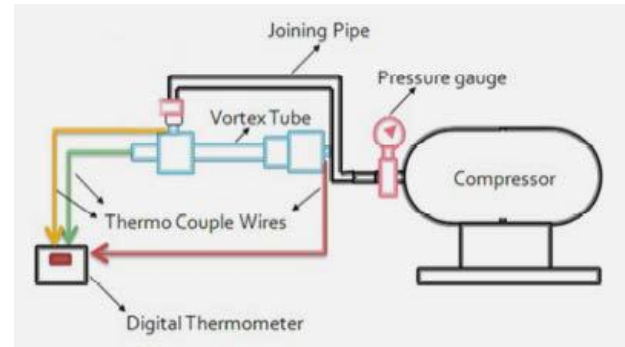

Fig. 2 Experimental Set Up

The experimental setup consists of compressor, vortex tube and temperature indicator. A stop valve at the compressor reservoir exit controls the inlet air to the vortex chamber. The inlet pressure is measured using pressure gauge. The temperatures of the air at inlet, at cold end, at hot end and ambient air are measured using thermocouple (copper constantan). Fig. 2 shows the overall view of the experimental setup. The compressor was initially run for about 20 min. to get a stable compressor air tank pressure of 4 bar (g). Temperatures at all location are tabulated. Then the same sets of readings are taken at a pressure of 4, 5, 6, 7 and 8 bars. The temperatures of the air at cold and hot end are the vital parameters that determine the COP of the vortex tube. The experiment is conducted with different surface roughness hot tubes.

MATHEMATICAL ANALYSIS

List of symbols

COP - Coefficient of performance

C_p - Specific heat at constant pressure (kJ/kg K)

D - Vortex tube inner diameter (m)

P_{in} - Inlet pressure (bar)

m_h - Hot mass flow rate (kg/sec)

m_c - Cold mass flow rate (kg/sec)

m_{in} - Inlet mass flow rate (kg/sec)

RHVT – Ranque - Hilsch vortex tube

r - Radial coordinate

T_h - Hot outlet temperature ($^{\circ}$ C)

T_c - Cold outlet temperature ($^{\circ}$ C)

T_{in} - Inlet temperature ($^{\circ}$ C)

D_{Th} - Temperature difference between the inlet and the hot outlet,

$$D_{Th} = T_h - T_{in} D$$

T_c - Temperature difference between the inlet and the cold outlet,

$$DT_c = T_{in} - T_c$$

When vortex tube is used as a cooling device (cold stream is used), the device is called refrigerator and the COP is calculated by dividing the desired output (cooling load) on required input (compression energy). The compression energy is calculated for isothermal process (at constant temperature) which represents the minimum ideal compression work. While the cooling load is calculated for ideal gas as shown below

$$COP_R = \frac{\text{Cooling load}}{\text{Isothermal compression energy}} = \frac{\dot{m}_c C_p (T_{in} - T_c)}{\dot{m}_{in} R T_{in} \ln(P_{in}/P_{atm})} \quad (1)$$

$$COP_R = \epsilon \left(\frac{C_p}{R} \right) \frac{1 - T_c/T_{in}}{\ln(P_{in}/P_{atm})} \quad (2)$$

The isothermal compression energy assumption is adopted in this study since the compressor is kept running in a steady mode while compressed air is stored in a large container (1 m³) with enough surface area to keep the compressed air at uniform room temperature during the test. When vortex tube is used as a heating device (hot stream is used), the device is called heat pump and the COP of the heat pump is defined as follow:

$$COP_{HP} = \frac{\text{Heating load}}{\text{Isothermal compression energy}} = \frac{\dot{m}_h C_p (T_h - T_{in})}{\dot{m}_{in} R T_{in} \ln(P_{in}/P_{atm})} \quad (3)$$

$$COP_{HP} = (1 - \epsilon) \left(\frac{C_p}{R} \right) \frac{T_h/T_{in} - 1}{\ln(P_{in}/P_{atm})} \quad (4)$$

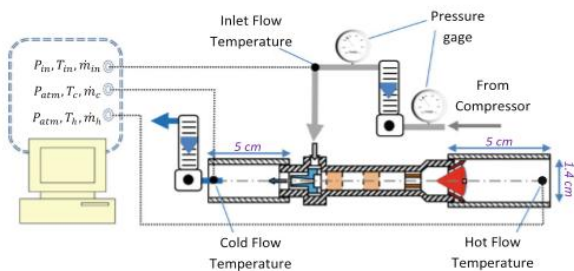

Fig 3 Vortex Tube Specification

From the Fig. 4 it is clear that at any given pressure the Cold End Temperature of the 6.264 μm surface roughness hot tube is better when compared to 3.133 μm and 4.510 μm surface roughness hot tubes and the temperature difference between them is inversely proportional to pressure i.e., the temperature difference is increasing progressively with pressure. From the Fig. 5 the Hot End Temperature of the 6.264 μm surface roughness hot tube is more compared to 3.133 μm and 4.510 μm surface roughness's hot tubes. From this we can say that temperature difference between them is proportional to pressure i.e., the temperature B difference is increasing progressively with pressure. Fig. 5 is plotted for pressure V/s COP. From the graph it is noted that the COP of the vortex tube with 6.264 μm surface roughness hot tube is higher than the 3.133 μm and 4.510 μm surface roughness hot tubes. From the Fig. 5, Fig.6, it is noted that the performance of the vortex tube with 6.264 μm surface roughness hot tube is better than the vortex tube with 3.133 μm and 4.510 μm surface roughness hot tubes. After evaluating the performance of vortex tube with cylindrical hot tubes of different surface roughness it was found that the vortex tube with high surface roughness hot tube gives the better performance than the cylindrical hot tube with low surface roughness i.e. there is an increase in COP of about 7%-52%. The Cold temperature, hot temperature and COP values obtained for cylindrical hot tubes at various pressures are

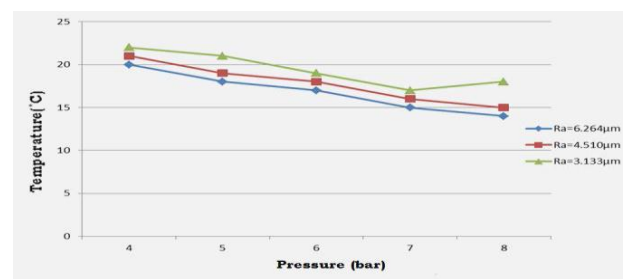

Fig 4 Inlet Pressure v/s Cold End Temp

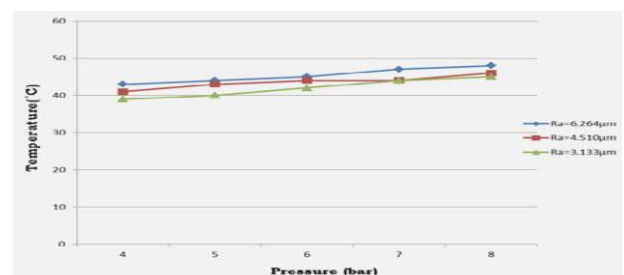

Fig 5 Inlet Pressure v/s Hot End Temperature

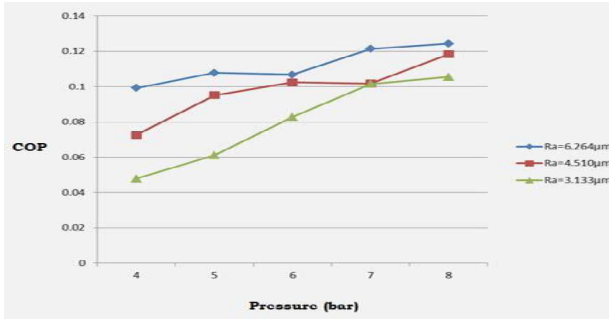

Fig 6 Inlet Pressure v/s COP

RESULT AND DISCUSSION

From the Fig. 4 it is clear that at any given pressure the Cold End Temperature of the 6.264 µm surface roughness hot tube is better when compared to 3.133 µm and 4.510 µm surface roughness hot tubes and the temperature difference between them is inversely proportional to pressure i.e., the temperature difference is increasing progressively with pressure. From the Fig. 6 the Hot End Temperature of the 6.264 µm surface roughness hot tube is more compared to 3.133 µm and 4.510 µm surface roughness's hot tubes. From this we can say that temperature difference between them is proportional to pressure i.e., the temperature difference is increasing progressively with pressure. Fig. 6 is plotted for pressure V/s COP. From the graph it is noted that the COP of the vortex tube with 6.264 µm surface roughness hot tube is higher than the 3.133 µm and 4.510 µm surface roughness hot tubes. From the Fig. 4, Fig. 5, Fig. 6 it is noted that the performance of the vortex tube with 6.264 µm surface roughness hot tube is better than the vortex tube with 3.133 µm and 4.510 µm surface roughness hot tubes . After evaluating the performance of vortex tube with cylindrical hot tubes of different surface roughness it was found that the vortex tube with high surface roughness hot tube gives the better performance than the cylindrical hot tube with low surface roughness i.e. there is an increase in COP of about 7%-52%. The Cold temperature, hot temperature and COP values obtained for cylindrical hot tubes at various pressures are

Table.1. Vortex Tube with 6.264 µm surface roughness hot tube

S:NO	Pressure Pi(bar)	Cold temperature Tc (°C)	Hot temperature Th (°C)	COP
1	4	20	43	0.0992
2	5	18	44	0.1078
3	6	17	45	0.1067
4	7	15	47	0.1214
5	8	14	48	0.1266

Table.2. Vortex Tube with 4.510 µm surface roughness hot tube

S:NO	Pressure Pi(bar)	Cold temperature Tc(°C)	Hot temperature Th(°C)	COP
1	4	21	41	0.0721
2	5	19	43	0.0951
3	6	18	44	0.1024
4	7	16	44	0.1017
5	8	15	46	0.1189

Table.3. Vortex Tube with 3.133 µm surface roughness hot tube

S:NO	Pressure Pi(bar)	Cold temperature Tc (°C)	Hot temperature Th (°C)	COP
1	4	22	39	0.0478
2	5	21	40	0.0611
3	6	19	42	0.0828
4	7	17	44	0.1015
5	8	18	45	0.1054

Table.4. Comparison of COP of cylindrical hot tubes with Ra=6.264 µm & Ra=4.510 µm

S.NO	Pressure in Bar	COP of cylindrical hot tube Ra=6.264µm	COP of cylindrical hot tube Ra=4.510µm	% increase in COP of Ra=6.264µm hot tube
1	4	0.0992	0.0726	26.81
2	5	0.1078	0.0951	11.78
3	6	0.1067	0.1024	04.03
4	7	0.1214	0.1017	16.23
5	8	0.1266	0.1184	06.48

Table.5. Comparison of COP of cylindrical hot tubes with Ra=6.264 µm & Ra=3.133 µm

National Conference on Current Trends in Engineering, Science and Technology (NACCTEST- 2018)
Organized by GF's Godavari College of Engineering, Jalgaon
International Journal of Innovations in Engineering and Science, Special Conference Issue, 2018
www.ijies.net

Table 5. Comparison of COP of cylindrical hot tubes with $Ra=6.264 \mu\text{m}$ & $Ra=3.133 \mu\text{m}$

S NO	Pressure in Bar	COP of cylindrical hot tube $Ra=6.264\mu$	COP of cylindrical hot tube $Ra=3.133\mu\text{m}$	% increase in COP of $Ra=6.264\mu\text{m}$ hot tube
1	4	0.0992	0.0478	51.81
2	5	0.1078	0.0611	43.32
3	6	0.1067	0.0828	22.39
4	7	0.1214	0.1015	16.39
5	8	0.1266	0.1054	16.75

The performance of the vortex tube was evaluated by conducting the experiment by replacing the cylindrical hot tubes with different surface roughness at various inlet pressures. The other parameters like orifice diameter, nozzle is kept unchanged. The highest COP is obtained at 8 bar for cylindrical hot tube of $Ra=6.264 \mu\text{m}$ and the value is 0.1266. The lowest cold temperature for vortex tube with cylindrical hot tube of $Ra=6.264 \mu\text{m}$ is 14°C at 8 bar and with cylindrical hot tube of $Ra=4.510 \mu\text{m}$ is 15°C at 8 bar and with cylindrical hot tube of $Ra=3.133 \mu\text{m}$ is 18°C at 8 bar. The highest hot temperature for vortex tube with cylindrical hot tube of $Ra=6.264 \mu\text{m}$ is 48°C at 8 bar and with cylindrical hot tube of $Ra=4.510 \mu\text{m}$ is 46°C at 8 bar and with cylindrical hot tube of $Ra=3.133 \mu\text{m}$ is 45°C at 8 bar. Cold mass fraction obtained is better for the vortex tube with the cylindrical hot tube of $Ra=6.264 \mu\text{m}$ than the cylindrical hot tubes of $Ra=4.510 \mu\text{m}$ & $Ra=3.133 \mu\text{m}$ as shown in tables above. The maximum of 34°C difference between hot and cold ends temperature for vortex tube with the cylindrical hot tube of $Ra=6.264 \mu\text{m}$ and maximum of 31°C difference between hot and cold ends temperature for vortex tube with the cylindrical tube of $Ra=4.510 \mu\text{m}$ is obtained and maximum of 27°C difference between hot and cold ends temperature for vortex tube with the cylindrical tube of $Ra=3.133 \mu\text{m}$.

CONCLUSION

A series of experiments have been conducted to investigate the performance of the vortex tube under several design parameters mainly: (1) inlet pressure, (2) cold mass fraction, (3) number of inlet nozzles, (4) vortex stopper location, (5) nozzle inlet angle, and (6) nozzles arrangements. The following were concluded from the experimental data. The inlet pressure is the driving force for the energy separation. Experimental

data show that a higher temperature difference and a higher COP are achieved as inlet pressure increases. However, the increase in COP depends on other parameters related to the vortex tube. The cold mass fraction is an important parameter influencing the performance of the energy separation in the vortex tube. And there is an optimum value to obtain maximum temperature difference which is not the same for maximum energy load separation or COP. The effect of number of nozzle is very important. For constant inlet pressure test, it is clear that there an optimum number of nozzles for maximum COPHP which depends on the vortex tube operating condition and parameters. For the current vortex geometry, the increase in the number of nozzles shows an inverse effect on COP.

The effect of the cylindrical hot tubes on the cold temperature drop, hot temperature raise, and COP of the Vortex tube are analyzed and the results obtained. The Cold drop temperature ΔT_c increases with increase in inlet air pressure. The Hot temperature raise ΔT_h increases with increase in inlet air pressure. The COP of the vortex tube increases with increase in inlet pressure. From the results obtained, it was found that the performance of the vortex tube is better for high surface roughness hot tube. The optimum end gate value opening gives the best performance. The effect of nozzle design is more important than the cold orifice design in getting higher temperature drops. The surface finish of the nozzle and the hot tube plays a great role in the performance of the vortex tube, good surface finish leads to the better performance. So, care to be taken while fabrication of the parts to obtain to get good surface finish. The graphs drawn are showing the effect of increasing the inlet pressure with the temperature drop shows an increase trend i.e. initially with increase in the inlet pressure the temperature drop.

REFERENCES

- [1] Ranque GJ (1933) Experiments on expansion in a vortex with simultaneous exhaust of hot air and cold air. *J Phys Radium (Paris)* 4:112–114 S-115, June. Also translated as *General Electric Co., Schenectady Works Library (1947); T.F. 3294*
- [2] Ranque GJ(1934) Method and apparatus for obtaining from a fluid under pressure two outputs of fluid at different temperatures. *US patent 1:952,281*
- [3] Hilsch R (1947) The use of the expansion of gases in a centrifugal field as cooling process. *Rev Sci Instrum* 18(2):108–113

National Conference on Current Trends in Engineering, Science and Technology (NACCTEST- 2018)
Organized by GF's Godavari College of Engineering, Jalgaon
International Journal of Innovations in Engineering and Science, Special Conference Issue, 2018
www.ijies.net

- [4] *Eiamsa-ard S, Promvong P (2008) Review of Ranque-Hilsch effects in vortex tubes. Renew Sustain Energy Rev 12:1822–1842*
- [5] *Lewins J, Bejan A (1999) Vortex tube optimization theory. Energy 24:931–943*
- [6] *Eiamsa-ard S, Wongcharee K, Promvong P (2010) Experimental investigation on energy separation in a counter-flow Ranque-Hilsch vortex tube: effect of cooling a hot tube. Int Commun Heat Mass Transf 37:156–162*
- [7] *Nimbalkar SU, Muller MR (2009) An experimental investigation of the optimum geometry for the cold end orifice of a vortex tube. Appl Therm Eng 29:509–514*
- [8] *Dincer K, Baskaya S, Uysal BZ, Ucgul I (2009) Experimental investigation of the performance of a Ranque-Hilsch vortex tube with regard to a plug located at the hot outlet. Int J Refrig 32:87–94*
- [9] *Dincer K, Tasdemir S, Baskaya S, Uysal BZ (2008) Modeling of the effects of length to diameter ratio and nozzle number on the performance of counterflow Ranque-Hilsch vortex tubes using artificial neural networks. Appl Therm Eng 28:2380–2390*
- [10] *Aydın Orhan, Baki Muzaffer (2006) An experimental study on the design parameters of a counterflow vortex tube. Energy 31:2763–2772*
- [11] *Hamdan MO, Alawar A, Elnajjar E, Siddique W (2011) Experimental analysis on vortex tube energy separation performance. J Heat Mass Transf.*
- [12] *Eiamsa-ard S (2010) Experimental investigation of energy separation in a counter flow Ranque-Hilsch vortex tube with multiple*

Maximising the Heat Transfer Through Fins Using CFD as a Tool

Kumbhar Shanteshwar I.¹, Koli Tushar A.², Thakur.M.P.

¹ M Tech Thermal engg Student
 GF'S GCOE, Jalgaon, India, 425501

² Assistant Professor,
 GF'S GCOE, Jalgaon, India, 425501

³ Assistant Professor,
 GF'S GCOE, Jalgaon, India, 425501

¹Email:- shanteshwarikumbhar@gmail.com

Abstract –This study presents the results of computational numerical analysis of air flow and heat transfer in a light weight automobile engine, considering three different morphology pin fins. A numerical study using Ansys fluent® (Version 6.3.26) was conducted to find the optimum pin shape based on minimum pressure drop and maximizing the heat transfer across the Automobile engine body. The results indicate that the drop shaped pin fins show improved results on the basis of heat transfer and pressure drop by comparing other fins. The reason behind the improvement in heat transfer by drop shape pin fin was increased wetted surface area and delay in thermal flow separation from drop shape pin fin

Keywords- CFD, Continuum Type, FLUENT, Optimization, Simulation, Turbulence.

INTRODUCTION

Performance of various devices are based on heat transfer and widely used in the many industries, especially in power distribution sector (transformers), Automobile sector (engine cooling), Power Plant Sector, electric components, space industry etc. One of the useful methods to take away heat transfer from surface area of thermal device was extended surface or fins. Pin fin is suitable for numerous applications including heat

transfer removal from air cooled I C engines, Electrical Small Transfers etc. "Pin fin geometry highly affects the different heat exchangers efficiency although these devices are used in various industries. Drop shaped pin fins can show more heat transfer with lower pressure drop from system and it was used for heat exchange purpose from past decades." In past this type of research work was based on experimental study, but having large technical and financial issues which was overcome by use of CFD techniques. A computational study was performed by various researchers using commercial software's to find out optimal shaped fins. Various researchers considered heat transfer and pressure drop across the thermal devices surface area. CFD analysis follow top to bottom procedure to perform simulation for any type of research problems. The first step is known as pre-processing, in which geometry making, mesh generation and boundary conditions of particular problem were defined by user. The heat transfer and associated pressure drop behaviour are characterized by second step known as solution of problem statement made in first step. To find optimum shape or performance of any thermal device third step was very useful because in this step post processing of results was performed and conclusion was made by researches. International Journal of Recent advances in Mechanical Engineering (IJMECH) Vol.2, No.3, August 2013 The objective of this study was to find out optimum type of fins used for heat removal application for automobile

National Conference on Current Trends in Engineering, Science and Technology (NACCTEST- 2018)
 Organized by GF's Godavari College of Engineering, Jalgaon
International Journal of Innovations in Engineering and Science, Special Conference Issue, 2018
 www.ijies.net

engine. This task was performed by using CFD as a tool. Three basic shapes of pin fins will be used in this study to find best shape. Maximising the heat transfer pressure drop will be main criteria for selection of optimum pin fin.

2. GEOMETRICAL MODELLING

Methodology:-

For CFD simulation, first of all geometry of the wind duct was created using GAMBIT (a software). After geometry creation next step is to mesh the geometrical model, which was also done using GAMBIT. Next step in GAMBIT is to declare continuum type and bou the surfaces generated. Finally a mesh file is created, which is imported in FLUENT. After importing mesh file in FLUENT, dimensional units for CFD domain are specified. In FLUENT desired turbulence model was selected for viscous modeling review. After selection of turbulence model boundary conditions are specified. Fluent has capability to store value of physical parameters for any point in the domain for analysis. Seven points were created to store the value phy pressure. FLUENT is now ready to simulate flow problem. Simulation was done for unsteady mode. Finally, post processing was done for result analysis.

3. DESCRIPTION OF DUCT AND

3.1 Size of Duct

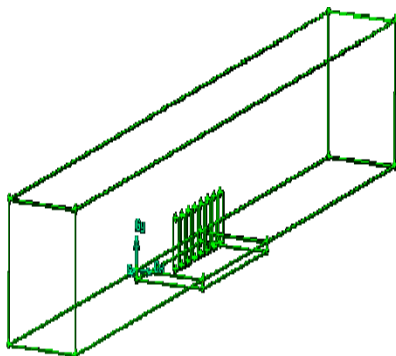

Figure 1 Diagram of Test Ring in CFD

3.2 Geometric modelling

Geometry: geometry generation is first step for making CFD domain. In gambit we can create both 2-D and 3-D shapes. In this case 3 In most of the problems shape of the domain is very complex. Some special operations are given in geometry mode to model complex geometries. The most significant operations are: unite, subtract, split, move, copy, align, rotate, translate etc. Figure 1 shows 3-D geometry used in our case. Furniture has been subtracted from main body of the room.

3.3 Meshing of CFD domain

After making geometry of the CFD results using CFD tool it was mandatory to use in GAMBIT software, where various tools are available to complete this task like mesh healing, dynamic refinement, aspect ratio etc. internal angle, face war-page, right handedness, negative volumes, cracks, and tetrahedral quality were used by authors, but in this paper only limited results were shown. Mesh sizes were kept different for zones. In Gambit, for meshing hexahedral element with sub map scheme was selected. No boundary layer was created in this case. Figure 2 represent meshed domain with hexahedral type meshing.

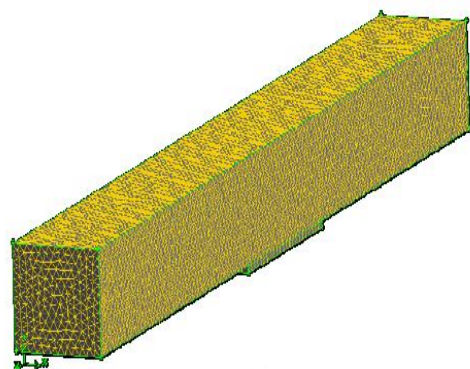

Figure 2 Meshed Domain

After mesh generation quality of mesh was checked in Gambit. Table 1 shows quality parameter like equisize skew. Here “from value” to “to value” represents quality parameter. Zero represent best and one represent worst

National Conference on Current Trends in Engineering, Science and Technology (NACCTEST- 2018)
Organized by GF's Godavari College of Engineering, Jalgaon
International Journal of Innovations in Engineering and Science, Special Conference Issue, 2018
www.ijies.net

element of grid. Figure 3 shows quality parameter aspect ratio, which shows that quality of the grid generated is good.

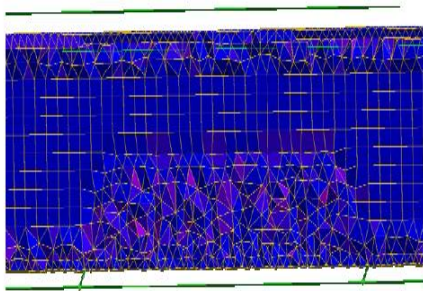

Figure 3 Aspect Ratio of Domain

Another Figure 4 shows that of the view of grid in Y-Z

The worst element for equi-size skew has a quality value of 0.6 to 1.0. This is ok, because only some elements are in the worst elements range.

3.4 Boundary Conditions for Domain

After mesh generation boundary conditions are defined for CFD domain. This process is done in Gambit. "Specify boundary type" icon is used to create boundaries. Gambit can be used to make mesh files for many different CFD Softwares. In this case FLUENT 6 was selected. After boundary creation next and last step is to define continuum type. In Gambit both f continuum type can be defined. As we are studying air flow, fluid continuum type was selected.

4. CFD SIMULATION

In this work FLUENT software is used for simulation. Main focus of this work is on heat transfer analysis of a duct for different types of Pin Fins. In CFD simulation selection of turbulence model is an important issue. Although in most of the research papers STD k for building simulation but k_ SST show better results.

Governing Equations and turbulence modelling

The governing equations for fluid dynamics are conservation equations for mass, momentum, and energy. The Governing Equations have actually been known for over 150 years. In the 19th century two scientists, Navier and Stokes described the equations for a viscous, compressible fluid, which are now known as

the Navier-Stokes Equations. These equations form a set of differential equations. The generic form of these relationships follows the advection diffusion

4. RESULT AND DISCUSSION

By completion of all the test runs in Fluent, several key performance indicators were studied to understand the heat transfer characteristics and trends for each pin-fin configuration. To understand results we study Temperature based results in graphical mode, Velocity results and Pressure based results.

4.1 Temperature Contour Results

Figure 5 to figure 19 provides a temperature contour like the previous figures, but in a vertical surface (from x-plane). Here it is clearer that heat transfer coefficient (total temperature) is higher between drop-shaped fin arrays. Heat transfer performance is based on turbulence effect created by fins shapes. The other important point is that because of high conductivity of material for both base of device and extended surface which an enhancing parameter is for heat transfer.

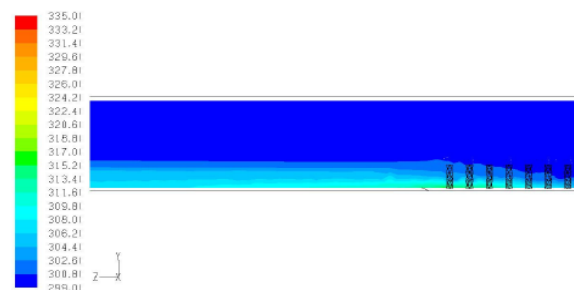

Figure 5 Temperature Contours of Cylindrical fin at plan x=25mm

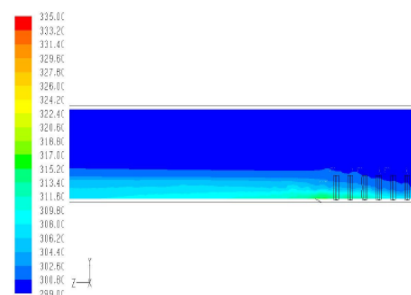

Figure 6 Temperature Contours of Drop fin at plan x=25mm

National Conference on Current Trends in Engineering, Science and Technology (NACCTEST- 2018)
 Organized by GF's Godavari College of Engineering, Jalgaon
International Journal of Innovations in Engineering and Science, Special Conference Issue, 2018
 www.ijies.net

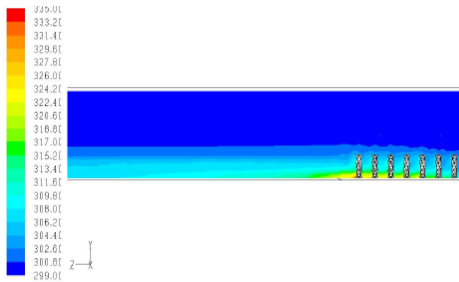

Figure 8 Temperature Contours of Cylindrical fin at plan x=37.5 mm

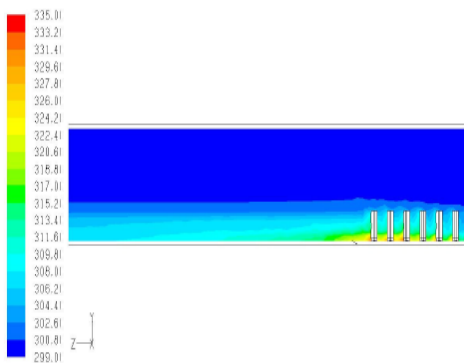

Figure 9 Temperature Contours of drop fin at plan x=37.5 mm

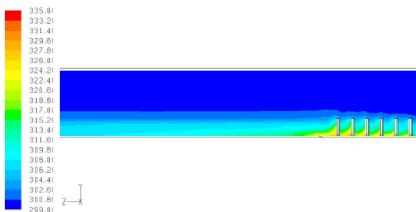

Figure 10 Temperature Contours of rectangular fin at plan x=37.5 mm

Recirculation flow acts as a wall preventing the fresh air contributes in heat transfer.

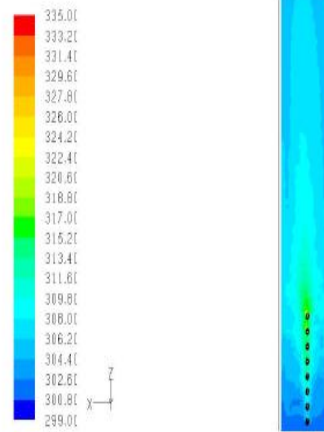

Figure 11 Cylindrical fin count temp at Y=5mm

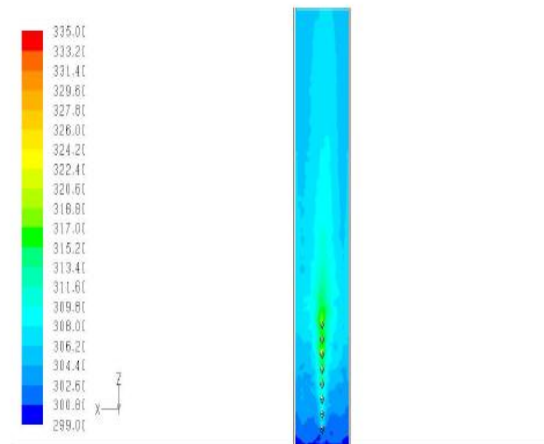
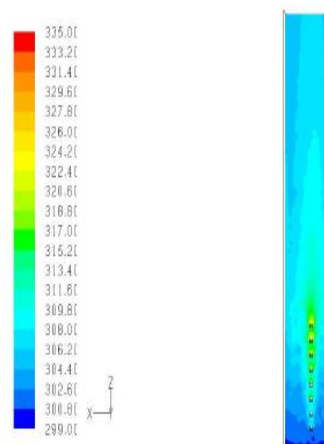

Figure 12 Drop fin count temp at Y=5mm

Figure 11 to figure 16 provides a contour plot for two virtual plane in y direction to show change in temperature profile for various fins used in this study. It is evident that the fins are affecting this temperature distribution. In the drop-shaped fins, thermal flow has reached the complete developed mode, more quickly than the other fins. The heat transfer coefficient has the highest value for the drop-shaped fins and the lowest value in the rectangular fins, because of geometry shapes and surface area of fins. The reason is that there is strong recirculation flow between fins in the rectangular fins. This recirculation reduced in the cylindrical and drop-shaped fins.



National Conference on Current Trends in Engineering, Science and Technology (NACCTEST- 2018)
 Organized by GF's Godavari College of Engineering, Jalgaon
International Journal of Innovations in Engineering and Science, Special Conference Issue, 2018
 www.ijies.net

Table 1 Equi-size skew in percentage

From value	To value	Count in range	Total count (in %)
0	0.1	28964	16.19
0.1	0.2	13512	7.55
0.2	0.3	30378	16.98
0.3	0.4	61324	34.27
0.4	0.5	22278	12.45
0.5	0.6	14135	7.90
0.6	0.7	6205	3.47
0.7	0.8	2145	1.20
0.8	0.9	0	0.0
0.9	1.0	0	0.0

Figure 16 Rectangular fin count temp at plan Y=20mm
 Figures 17 to 19 consist of different plots showing the temperature distribution in different parts of solution. From the figure 17, the temperature distribution seems close for all three cases used in this study; where there is a small difference between outlet temperatures occurs. The difference is less than 1°C.

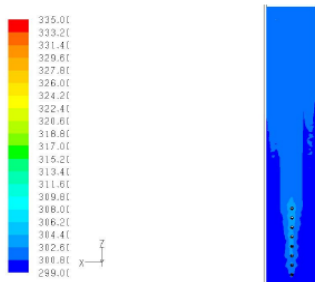

Figure 14 cylindrical fin count temp at plan Y=20mm

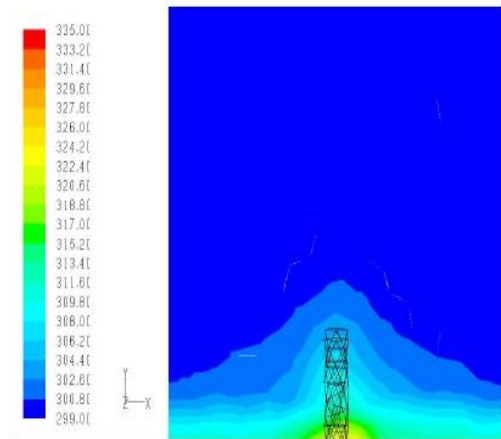

Figure 17 Temperature Contours of cylindrical fin at plan Z=38 mm

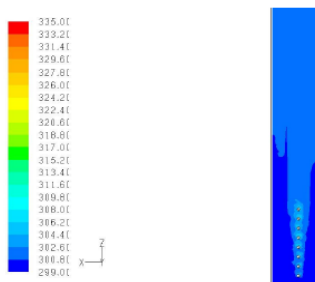

Figure 15 Drop fin count temp at plan Y=20mm

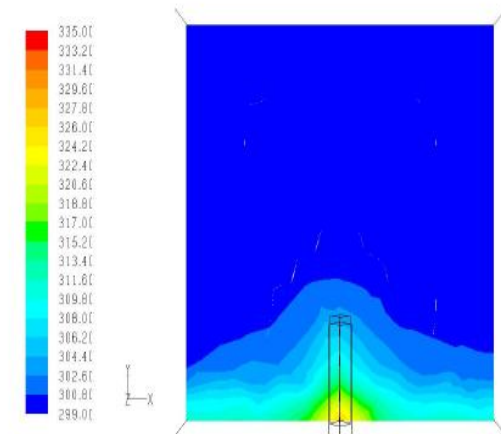
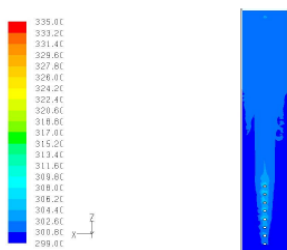

Figure 18 Temperature Contours of drop fin at plan Z=38 mm



National Conference on Current Trends in Engineering, Science and Technology (NACCTEST- 2018)
 Organized by GF's Godavari College of Engineering, Jalgaon
International Journal of Innovations in Engineering and Science, Special Conference Issue, 2018
 www.ijies.net

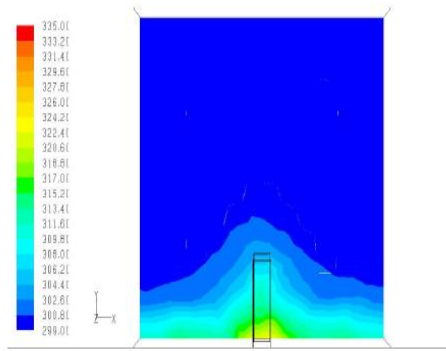

Figure 19 Temperature Contours of rectangular fin at plan Z=38 mm

4.2 Pressure plots (inlet outlet)

It is seen that the pressure loss is higher in the rectangular pins which was shown in figure 20 to figure 25 when comparing with all case used in this study. The drop-shaped fins have the least pressure loss. The reason is that in rectangular fins case, air flow particles follow a smoother path line structure. Figure 20 to Figure 25 shows Total pressure plots on inlet and outlet conditions.

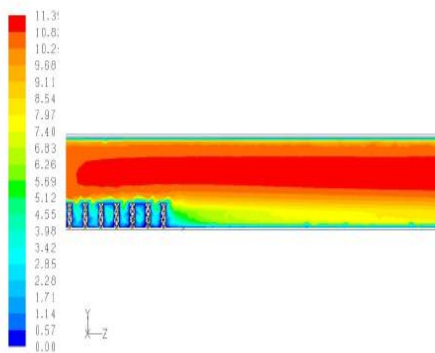

Figure 20 Velocity Plot for Cyl Pin Fin

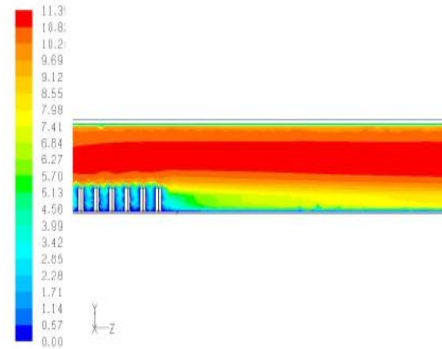

Figure 21 Velocity Plot for Drop Pin Fin

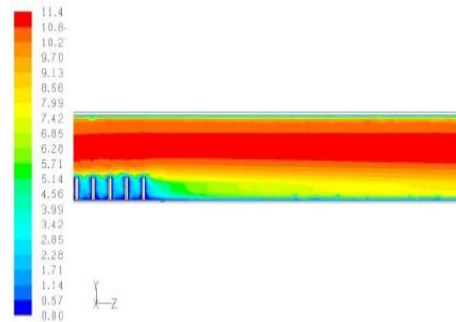

Figure 22 Velocity Plot for Rect Pin Fin

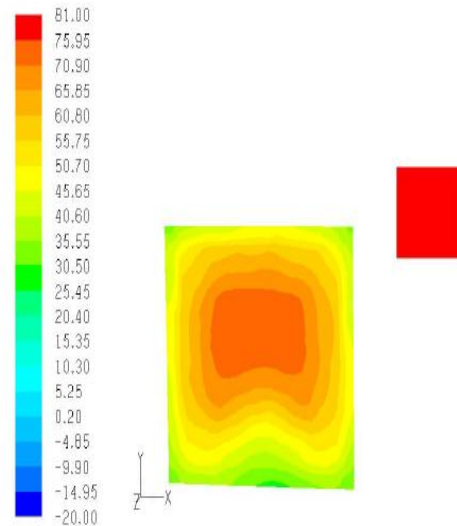

Figure 23 Total Pressure Plot for Cyl Pin Fin

National Conference on Current Trends in Engineering, Science and Technology (NACCTEST- 2018)
 Organized by GF's Godavari College of Engineering, Jalgaon
International Journal of Innovations in Engineering and Science, Special Conference Issue, 2018
 www.ijies.net

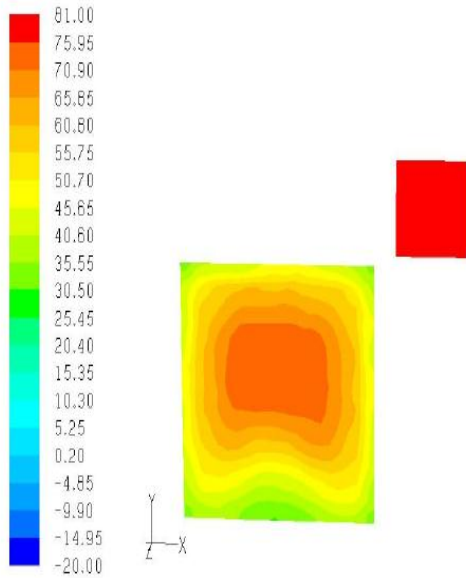

Figure 24 Total Pressure Plot for Drop Shaped Pin Fin

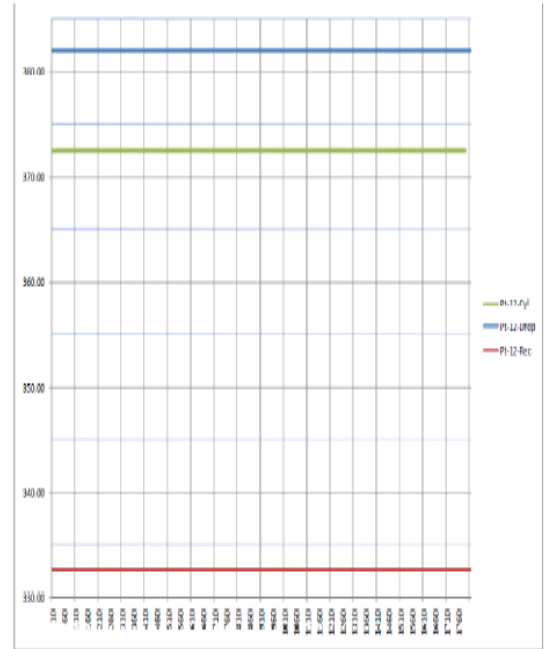

Figure 26 Temperature plot on VP-12 for all type Fins

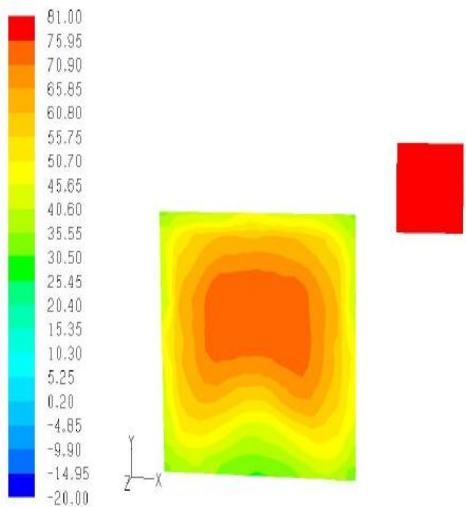

Figure 25 Total Pressure Plot for Rect Pin Fin

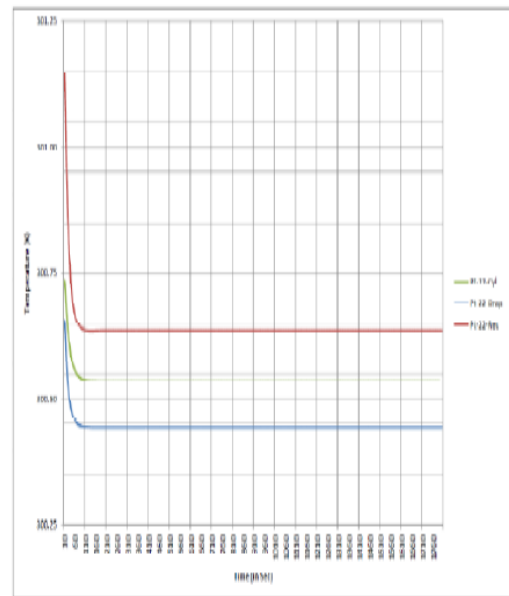

Figure 27 Temperature plot on VP-22 for all type Fins

4.3 Velocity plots

Velocity plots are very helpful to understand air flow analysis in fins. It should be noted here that the H/D ratio for drop-shaped pin-fins is smaller than the other ones (but wetted surface area is equal for all). This behaviour can be reasoned by noticing the figure 26 to 28. It can be seen that for Drop-shaped pin-fins, flow is accelerated in pin-fin section which could cause more friction and pressure drop in fins top section

National Conference on Current Trends in Engineering, Science and Technology (NACCTEST- 2018)
Organized by GF's Godavari College of Engineering, Jalgaon
International Journal of Innovations in Engineering and Science, Special Conference Issue, 2018
www.ijies.net

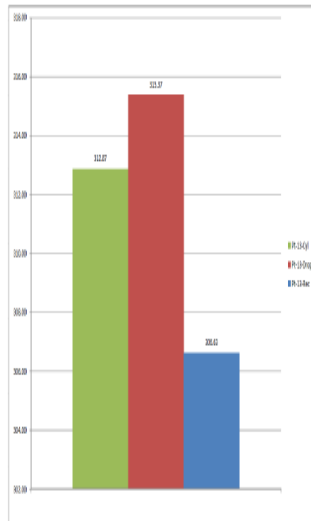

Figure 28 Temperature plot on VP-13 for All type Fins

CONCLUSIONS

A reasonable comparison of various pin-fin geometries has been attempted. A three-dimensional conjugate problem has been studied with a three-dimensional CFD model. These were greatly simplified by assuming 1-column in-line pin-fins with axes perpendicular to the flow and isothermal heat transfer surfaces. At lower values of pressure drop and pumping power, drop shaped fins work best. At higher values, drop-shaped fins and Circular fins offer highest performance. For high Reynolds numbers, the fins thermal efficiency and effectiveness show same behaviour, but drop-shaped fins configuration always stand a little bit upper. Also its variation in different flow regimes is smoother, which means that the engine performance varies according the working load conditions. In last it was important to show that CFD tool is good approach to analysis thermal behaviour of any thermal device. For future work refinement of mesh was good approach to refine results and validation of CFD results will give more benefit to users.

REFERENCES

[1] S.R Mcilwain, "Improved prediction methods for finned tube bundle heat exchangers in cross flow", PhD Thesis, University of Strathclyde, Glasgow, 2003

- [2] S.R Mcilwain, "A comparison of heat transfer around a single serrated finned tube and a plane finned tube", *IJRS*, pp 88-94, 2010
- [3] C. Weierman, "Pressure drop data for heavy duty finned tubes", *Chemical engineering progress*, 73, pp 69-72, 1977
- [4] C. Weierman, "Correlations ease the selection of finned tubes", *The Oil and Gas Journal*, Vol.74, pp 94-100, 1976
- [5] V. Ganapathy, "Design and evaluate finned tube bundles", *Hydrocarbon processing*, Vol.75, No.9, pp103-111, 1996
- [6] Poulidakos, A. and Bejan, A., "Fin Geometry for Minimum Entropy Generation in Forced Convection" *ASME Journal of Heat Transfer*, Vol 104, pp. 616-623.
- [7] Incropera F. P., DeWitt D. P., 1996, "Fundamentals of heat and m Wiley & Sons, Pg. No. : 147-172.
- [8] P. K. Nag, 2006, "Heat & Mass Transfer", 2nd Edition, Tata McGraw Hill Co. Pg. No. : 86 425-449
- [9] J. P. Holman, 2004, "Heat Transfer", 9th Edition, Tata McGraw Hill Co., Pg. No.
- [10] Yunus A. Çengel, 2004, "Heat Transfer Hill Co., Pg. No. : 156-168, 333
- [11] H.Y. Pak, K. Park, and M.S. Choi, "Numerical Analysis of the Flow and Heat Transfer Characteristics for Forced Convection" *KSME Int. J.*, Vol. 12 no. 2, 1998, pp. 310~319.
- [12] X.Liu, and M.K. Jensen, "Geometry Effects on Turbulent Flow and Heat Transfer in Internally Finned Tubes," *ASME J. of Heat Transfer*, Vol.123, 2001, pp. 1035~1044.
- [13] G. Fabbri, "Heat Transfer Optimization in Internally Finned Tubes Under Laminar Flow Conditions, *Int. J. of Heat and Mass Transfer*, Vol.41, No.10, 1998, pp.1243
- [14] J. Lee, J. S. Lee, and K. Park, , *Flow/Heat Transfer Analysis and Shape Optimization of a Heat Exchanger with Internally Finned Tube*, *Trans. of the KSME (B)*, Vol.29, No.4, 2005, pp.1620
- [15] Sanghwan Lee ,Juhee Lee, Kyoungwoo Park, *An Application of Multi*

National Conference on Current Trends in Engineering, Science and Technology (NACCTEST- 2018)
 Organized by GF's Godavari College of Engineering, Jalgaon
International Journal of Innovations in Engineering and Science, Special Conference Issue, 2018
 www.ijies.net

Experimental Set Up For Measurement of Strain by Using Strain Gauges on Simply Supported Beam and Analysis on ANSYS

Salve Mohanraj¹, Tushar A. Koli², Dr.V.H.Patil³

¹ P.G. student,

GF'S GCOE, Jalgaon, India, 425501

² Assistant Professor,

Dept. of Mechanical Engineering, GF'S GCOE, Jalgaon, India, 425501

³ Associate Professor

Dept. of Mechanical Engineering, GF'S GCOE, Jalgaon, India, 425501

¹ Email:- mohanrajsalve19@gmail.com

Abstract – The accurate assessment of stress, strain and loads in components under working conditions are an essential requirement of successful engineering design. Experimental stress analysis over years has been playing an increasingly important role in aiding engineering product designers to produce not only efficient, economic designs but also in substantial reductions in weight and yet aid in easier manufacturing of the products. This study develops a strain measurement test rig for beam structures subjected to point load acting at middle of the beam by using the strain gauges and for validation purpose analysis on ansys and compare with analytical values. Electrical resistance strain gauges are used as a sensor in wide variety of applications. And fairly inexpensive is used as a sensor in wide variety of applications. Load cell transducer is the most prevalent sensor which uses electrical strain gauges. In a load cell, the unknown, load is measured by sensing the strain developed in a mechanical member. Since the load is linearly related to the strain as long as the mechanical member remains elastic, the load cell can be calibrated so that the output signal is proportional to the load. The strain in the Simply Supported Beam will be calibrated and validated using numerical approach, analytical approach and experimental measurements.

Keywords-Stress, Strain, Wheat stone Bridge Circuit, Ansys.

INTRODUCTION

It is difficult to determine stresses for a structure which has a complex shape or which has several loads applied to it. Failure of a structural member or machine parts can be caused by excessive normal stress or shear stress and, thus, it is important to determine the maximum principal stress and maximum shear stress at any point concerned. Hook's law is at work between stress and strain when an object has elastic deformation caused by external force and, therefore, an experimental method is used that measures strain and subsequently, calculates stress. Among many experimental methods, ones using a strain gauge are relatively most convenient and easy to use, and consequently are widely applied.

This study is intended to develop a training support tool to help students to understand the relation between stress and strain, elastic modulus, and strain measurement principles using a strain gauge. To that end, an experiment was implemented that determined normal stress at an attached point with a strain gauge, on a

National Conference on Current Trends in Engineering, Science and Technology (NACCTEST- 2018)
Organized by GF's Godavari College of Engineering, Jalgaon
International Journal of Innovations in Engineering and Science, Special Conference Issue, 2018
www.ijies.net

simply supported beam after applying normal load at middle of the beam.

Strain is the amount of deformation of a body due to an applied force. More specifically, strain (ϵ) is defined as the fractional change in length, as shown in the Fig. 1. Strain can be positive (tensile) or negative (compressive) and is dimensionless. In practice, the magnitude of measured strain is very small. Therefore, strain is often expressed as micro strain ($\mu\epsilon$), which is $\epsilon \times 10^{-6}$ [2]

Principle of the strain Gauge

In the strain gauge test specimen and transmits the applied strain to the sensor. A bonded resistance strain gauge must be appropriately mounted to the specimen for which the strain is to be measured. The backing provides the surface used for bonding with an appropriate adhesive. Backing materials are available that are useful over temperatures that range from -210 to 290°C . The adhesive bond

Serves as mechanical and thermal coupling between the metallic gauge and the test specimen. As such, the strength of the adhesive should be sufficient to accurately transmit the strain experienced by the test specimen, and should have thermal conduction and expansion characteristics suitable for the application. If the adhesive shrinks or expands during the curing process, apparent strain can be created in the gauge [5]

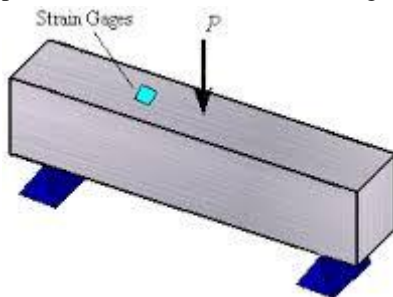

Fig 1-Strain Measured by Strain Gauge

The Wheatstone Bridge-Working Principle

The Wheatstone bridge (WB) (Fig. 1.2) is one of the most sensitive and precise methods, with the ability to measure small changes in resistance, which makes it frequently used nowadays for strain measurements. In a simple Wheatstone bridge circuit, input voltage (V_{in}) is applied across the bridge with four resistors, while in the middle of the bridge (between points A and B) output voltage (V_{out}) is measured. When R_g is the resistance of the strain gauge and R_1 , R_2 and R_3 are the resistors in the bridge, this bridge configuration is called a quarter-

bridge. In general, if we define n as the number of active gauges in the WB, $n=1$ for a quarter bridge, $n=2$ for a half bridge and $n=4$ for a full bridge [4]

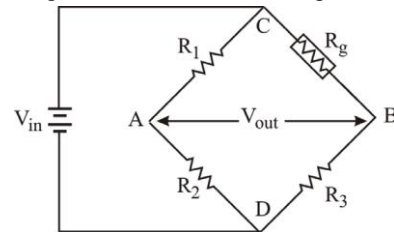

Fig 2-Wheatstone bridge circuit

EXPERIMENTAL SETUP

We perform an experiment on three different type of material i.e. Stainless Steel, Aluminum and Brass. with half bridge configuration. The Electrical resistance strain gauge as shown in Fig.4.

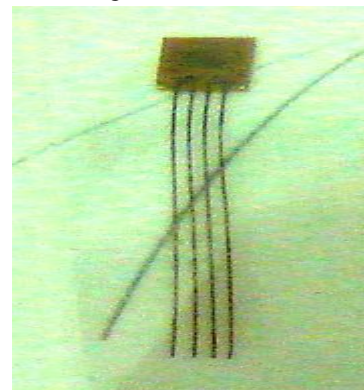

Fig 3 Electrical resistance strain gauge

EXPERIMENTAL PROCEDURE

A simply supported beam as shown in Fig.5 is subjected to a point load at the middle of the beam. The strain gauges are attached on its top and bottom surfaces to measure strain produced at that location. Here the 5 N load is applied at the middle of the beam. Strain gauges are connected to strain measurement instrument which works on wheat stone bridge circuit. The circuit will produce the output in terms of micro strain and output voltage in the form of millivolt (mV). The data is taken for various load on each beam and results are achieved [1]

ANALYSIS

To validate experimental measured results two approaches are adopted, first classical mechanics theory is used to predict the displacements and strain, Second Finite Element Method by using the commercially available FEA software are used to compare the same.

National Conference on Current Trends in Engineering, Science and Technology (NACCTEST- 2018)
 Organized by GF's Godavari College of Engineering, Jalgaon
International Journal of Innovations in Engineering and Science, Special Conference Issue, 2018
 www.ijies.net

The results of these three approaches are compared and plotted in the graphs shown in figure 6.

From the pure bending theory, we have, A beam with a moment of inertia I and with Young's modulus E will have a bending stress σ at a distance "y" from the Neutral Axis and the NA will bend to a radius r in accordance with the following formula.

$$\frac{M}{I} = \frac{\sigma}{y} = \frac{E}{r}$$

By getting the value of the stress the theoretical strain can be found out by using the hook's law formula.

By using FEA software the value at different nodes are also calculated to compare with experimental values.

RESULTS

We taking the strain reading for each material for different loading condition.

Table 1- Strain value on different materials

Load (N)	Strain on Materials		
	Stainless Steel	Alluminium	Brass
1	3*10-3	7*10-3	16*10-3
2	7*10-3	29*10-3	27*10-3
3	11*10-3	38*10-3	37*10-3
4	14*10-3	47*10-3	45*10-3
5	19*10-3	59*10-3	56*10-3

For validation purpose we are compare this experimental values with analytical and FEA software (ANSYS) values.

Table 2- ansys result

Load (N)	Strain on Materials		
	Stainless Steel	Aluminum	Brass
1	3*10-3	6*10-3	15.5*10-3

2	6*10-3	28*10-3	26*10-3
3	9*10-3	37*10-3	36*10-3
4	13*10-3	46*10-3	44.4*10-3
5	18*10-3	59*10-3	57*10-3

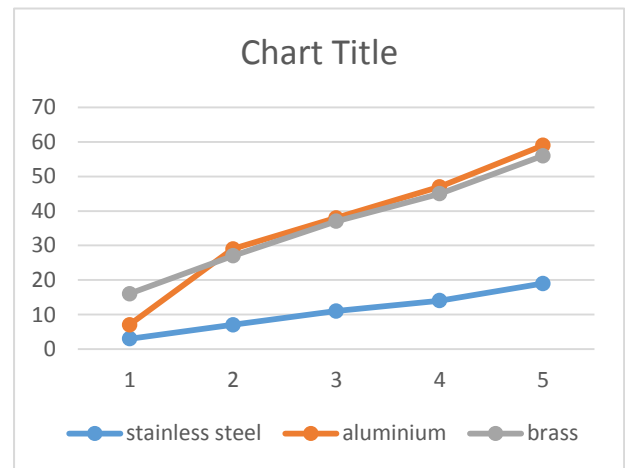

Fig 4-Graph load Vs stain experimental

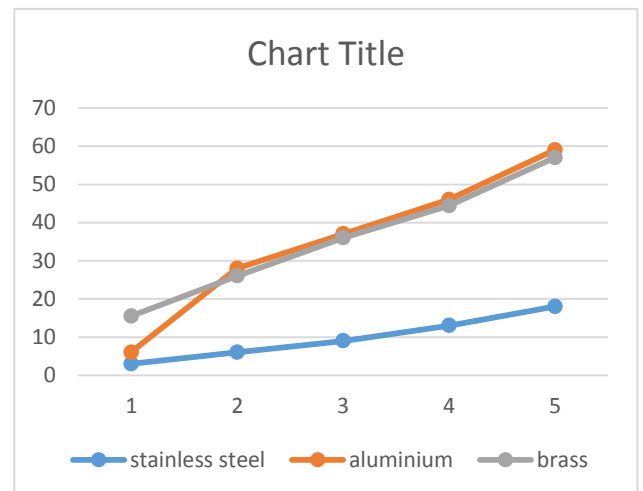

Fig:5 -Graph strain Vs load ansys results

Conclusion

An Experimented setup for the measurement of strain/stress has been successfully established using strain gauge measurement principle. The behavior of different materials under different load are validated using classical bending theory and FEA software (ANSYS). The characteristics curves for the load v/s strain, voltage are plotted for the Simply Supported Beam for the various loads. This test rig is thought to help students to effectively understand the principles of stress, elastic modulus, strain, which are important

National Conference on Current Trends in Engineering, Science and Technology (NACCTEST- 2018)
Organized by GF's Godavari College of Engineering, Jalgaon
International Journal of Innovations in Engineering and Science, Special Conference Issue, 2018
www.ijies.net

concepts in material mechanics, therefore, contributing to a maximum learning effect.

REFERENCES

- [1] *Ho-Kyung Kim & Se-Hyung Kang, Design and development of a training apparatus for strain measurement, Global Journal of Engineering Education, Volume 16 (2014), page number 13 to 19.*
- [2] *Prof. Bipin D. Patel, A.R.Srinivas, Validation of Experimental Strain Measurement Technique and Development of Force Transducer, International Journal of Scientific & Engineering Research, Volume 3, Issue 10, October-2012, page number 1 to 4.*
- [3] *Se Woon Choi,1 Jihoon Lee,1 Bo Hwan Oh,2 and HyoSeon Park1, Measurement Model for the Maximum Strain in Beam Structures Using Multiplexed Fiber Bragg Grating Sensors, International Journal of Distributed Sensor Networks Volume 2013, page number 1 to 9.*
- [4] *JelenaManojlović, PredragJanković, BRIDGE MEASURING CIRCUITS IN THE STRAIN GAUGE SENSOR CONFIGURATION, Series: Mechanical Engineering Vol. 11, No 1, 2013, pp. 75 - 84*
- [5] *Dr. Bridget M. Smyser, ' Strain Measurement in a Simply Supported Beam ', june 2005*

National Conference on Current Trends in Engineering, Science and Technology (NACCTEST- 2018)
Organized by GF's Godavari College of Engineering, Jalgaon
International Journal of Innovations in Engineering and Science, Special Conference Issue, 2018
www.ijies.net

DESIGN AND DEVELOPMENT OF FLYWHEEL TO GENERATE ELECTRICITY

Pravin Dharmaraj Patil¹, Viki Bhadane², Patil Harshal Bhagwan³, Bhalerao Prashant
gulabrao⁴

¹ Assistant Professor

SSBT's C.O.E.T. Bambhori, Jalgaon, India

² Principal

SVP's A.S.S.P. Institute of polytechnic, Chinchpura, India

^{3,4} Student

Dept. of mechanical Engineering, SSBT's C.O.E.T. Bambhori, Jalgaon.

¹Email:- pravinpatil100@rediffmail.com

Abstract – One such way is to develop alternate source of energy which will help us to save energy. Geothermal energy, biogas, solar energy, wind energy are various forms of energy which are used alternatively today. One such source of energy is Human Power . Power Generation Using human effort is a force for the future. With increasing demand for fuel and a new source of energy, development of human powered generators become a necessity. The most famous human powered generator is dynamo. On similar lines various human powered generators like backpack generators, biomechanical energy harvester and shoe generator are being developed. These harvesters are under development and are considered one of the best inventions of recent times.

Keywords- Flywheel, Electricity, Generation

INTRODUCTION

In a world with growing demand for energy, it has become a necessity for alternate source of energy. As a result various inventions have been made to overcome the issue. Increasing efficiency of electrical and mechanical products has been one of the ways to reduce energy consumption. These techniques are useful for reducing energy consumption. One such way is to

develop alternate source of energy which will help us to save energy. Geothermal energy, biogas, solar energy, wind energy are various forms of energy which are used alternatively today. One such source of energy is Human Power. Human power is an endless source of energy which has been wasted. Humans eat food and spend it on his work without proper conversion of energy.

LITERATURE SURVEY

Sunil Kumar Thakur et al. [1] conducted an experiment on "HUMAN POWERED SEWING MACHINE FOR CLEAN ELECTRIC POWER GENERATION" An innovative method of power generation. With the advent in the field of research to discover new renewable sources of energy it was found that if we exploit the increasing population, human muscle power could also be used as a resource of electric power. This motivated to modify a system that could trap the mechanical energy of human while sewing. Sewing machines are easily available and robust and it requires human power.

The main objective behind this present work is to provide energy to communities without electricity supply or people deprived of electricity for the basic needs like electrical power for small electronic devices like charging a cell phone ,or to run a portable radio,

National Conference on Current Trends in Engineering, Science and Technology (NACCTEST- 2018)
 Organized by GF's Godavari College of Engineering, Jalgaon
International Journal of Innovations in Engineering and Science, Special Conference Issue, 2018
 www.ijies.net

glowing LED lamps during night or when needed or running other small appliances. Normally sewing machines without any electric supply is used in the country side. Hence the idea conceived is to generate DC with the rotation of the rotating ridged knob when it comes in contact with the belt of the machine.

Ashinze E. Anthony et Al. [2] conducted an experiment on "Design and Fabrication of a Pedal Operated Power Generator." Using human powered generation gives a power source that is not directly derived from natural sources. An example is that a human powered generator can be operated if there is no sun for solar generation, no wind for wind generation, and no water for hydro generation. The power generated from pedal is perfect for remote areas, hilly regions, strategic location, Islands etc., where electricity generation is scanty if not nil. In these situations, a small portable power generating unit would be of great help to provide power supply to charge battery-operated gadgets like mobile phones, lamps, radio, communication devices, etc. It is important to visualize new ways to bring power to the people as population continues to grow and power shortages continue to occur. Much of the power that is provided to people today is done in very un-sustainable ways; new ideas are needed to transit into a post cheap-petroleum era. This design relates to very compact and easily portable power-generating unit, which besides being used as a power generator can also be used as cycle exerciser. It serves dual purpose of power generation and helping the person to maintain physical fitness through exercise of muscles of legs. It can be pedaled or cranked by hand/foot to charge 12 volt batteries and run small appliances.

Jeff Hines et Al. [3] a local Flagstaff teacher who also served as the first Wind Senator in Arizona, inspired us to pursue bicycle generators for use in K-12 classrooms. Shortly after, we learned of an NAU student, Matthew Petney, who had built a double-bike generator, which included a battery for energy storage and an inverter and outlet so normal 120-volt devices could be plugged into it. We purchased the system from Matt and shared it with several interested teachers and classes as an educational tool.

Billions in Change et Al. [4] in experiment of "Free Electric bike generates electricity with pedal power" in 2015, Using pedal power to generate electricity is not a

new idea, of course, but Billions in Change says it has been able to refine the concept. "Energy-producing bikes are not new, but before Free Electric there wasn't anything that produced enough electricity to power 24 light bulbs, a fan, a phone and tablet charger at the same time," the group states on its website.

The Free Electric was conceived about three years ago. The initial prototype didn't work, but the design has undergone iterative development until a working version was created. Bhargava tells Gizmag that each working part of the bike has then been refined to be made as simple as possible.

BLOCK DIAGRAM

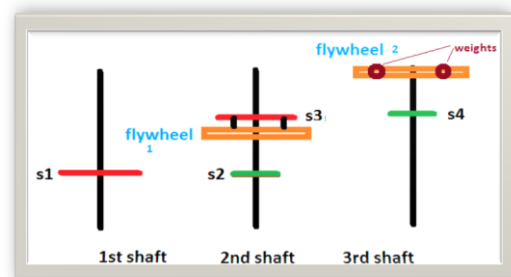

To reduce losses we must apply following modifications

- 2nd sprocket changes.
- Addition of flywheel to intermediate shaft.
- Replacement of 3rd sprocket
- Flywheel modifications.

1. PRINCIPLE OPERATION OF ENERGY FLYWHEEL

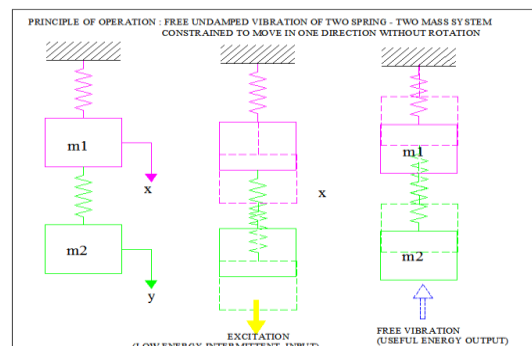

National Conference on Current Trends in Engineering, Science and Technology (NACCTEST- 2018)
 Organized by GF's Godavari College of Engineering, Jalgaon
International Journal of Innovations in Engineering and Science, Special Conference Issue, 2018
 www.ijies.net

The figure shows free un-damped vibrations [5] set up of two mass- two spring system. As shown in the figure the input to the system is in the form of an low energy intermittent input from any power source (excitation) , this results in free un-damped vibrations are set up in the system resulting in the free to and fro motion of the mass (m1)& (m2) , this motion is assisted by gravity and will continue until resonance occurs, ie, the systems will continue to work long after the input (which is intermittent) has ceased. Hence the term free energy is used.

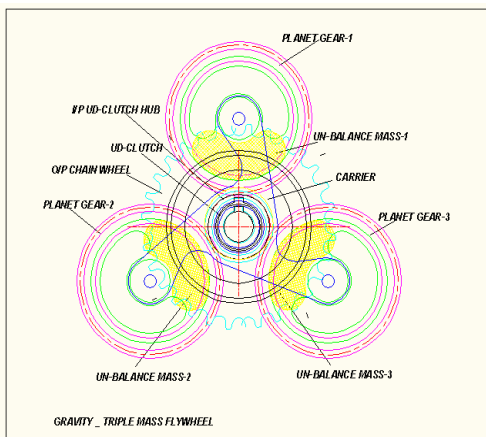

Hence when rotary input is applied to the ud –clutch hub it rotates the carrier, thus the planet gears with un-balance masses will revolve about the sun, but at the same time un-balance mass-1 will fly-outward due to centrifugal force , this makes planet gear one to rotate about its own axis , this will cause sun gear to also rotate as it is constant mesh with planet gear, simultaneously planet gear will also rotate making un-balance mass to move inward –centripetal force is generated. These two forces create a couple that makes the flywheel gain momentum in rotational direction this process is repeated in cyclic manner by each planet gear thus after a few rotations as input the flywheel has developed enough inertia such that the bi-cycle will no longer require continuous pedaling only intermittent pedaling will be sufficient to make it move the distance Outcome of the flywheel will result in lesser effort to be applied by the pedaled to cover the same distance thereby saving human energy input.

OUTPUT AND CALCULATIONS

Given Data

For S₁-

$$N_1 = 1$$

$$t_1 = 70, t_2 = 24, N_2 = ?$$

$$N_2 = (t_1 \times N_1)/t_2 = (70 \times 1)/24$$

$$N_2 = 2.91 \approx 3$$

As you see , by changing the sprocket with less number of teeth it gives addition in output , i.e. N₂ changes from 2 to 3.

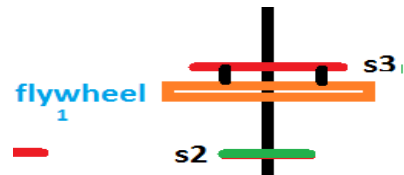

- In classical model flywheel is attached to 3rd shaft and modifies the output by 1 : 1.4 ratio.
- So we modified our structure with intermediate flywheel 1.so it can change

$$N_2 = 3 \text{ to } N(\text{flywheel 1}) = 4 \text{ to } 5$$

As N(flywheel 1) and N₃ is on same shaft so

$$N(\text{flywheel 1}) = N_3 = 5$$

$$\text{Now } N_3 = 5, t_3 = 70, t_4 = 24, N_4 = ?$$

$$N_4 = (N_3 \times t_3)/t_4 = (5 \times 70)/24$$

$$N_4 = 14.58 \approx 15$$

So as we see how up to this step we get output

$$N_4 = 15 , \text{ which is 7.5 times more than classical model}$$

Flywheel modifications

General flywheel extend input to 1.4 time for output. But we replace this flywheel with energy flywheel. As per this modification , which is already developed by Sir kanak gogoi [6] , from his documentation number of revolution of output is 1.8 times to input.

$$\text{So } N(\text{flywheel 2}) = 1.8 \times N_4 = 1.8 \times 15 = 27$$

ADVANTAGES-

National Conference on Current Trends in Engineering, Science and Technology (NACCTEST- 2018)
Organized by GF's Godavari College of Engineering, Jalgaon
International Journal of Innovations in Engineering and Science, Special Conference Issue, 2018
www.ijies.net

1. The energy produced is extremely clean source of energy.
2. It benefits the health by exercise point of view
3. Benefits for your peace of mind
4. Time and effort required is medium
5. Saves money which are used for batteries
6. Power generation is simply pedaling on this arrangement

LIMITATIONS

1. Creates some additional drag on your tires, more work for the peddler
2. Bike powered generators are not sustainable
3. Generating electricity is not for heavy works
4. Mechanical moving parts is there
5. Initial cost of this arrangement is high

APPLICATIONS

1. Used save Environment from Pollution
2. For glowing of led bulbs & CFL bulbs
3. House hold
4. Gymnasium
5. All collages

CONCLUSIONS

Human powered generators are the future of human kind. If mobile phone, laptops get charged while doing our daily chores it will reduce consumption of power to substantial value. This technology requires development but is a proper solution to our energy woes. Biomechanical energy harvester has been rated among the 50 best inventions of 2008. Development of power generating gym equipment will result into a wonderful development in human powered generators.

In concluding the words of our project, since the power generation using gym get its energy requirements from the Non-renewable source of energy.

There is no need of power from the mains and there is less pollution in this source of energy. It is very useful to gym and house hold and gyms. Generated Electricity from our system is Renewable Energy Source. It's total Pollution free means Save Environment as well as Earth. Exercise is important for human health so our device exercised also done. In countries like India where ample human power is available, such human powered man machine systems will help in a great extend to improve the economic condition and employability of such countries in backward or remote areas. This system is only used for small type of devices not Suitable for heavy devices such systems are of utmost importance in Asian countries as almost all Asian countries are facing electricity scarcity which results in ten to twelve hours load shedding in rural areas.

REFERENCES

- [1] Sunil Kumar Thakur, an experiment on "HUMAN POWERED SEWING MACHINE FOR CLEAN ELECTRIC POWER GENERATION". *Choosing muscle over machine (2008)*.
- [2] Ashinze E. Anthony, an experiment on "Design and Fabrication of a Pedal Operated Power Generator." *Innovative Systems Design and Engineering* www.iiste.org ISSN 2222-1727 (Paper) ISSN 2222-2871 (Online) Vol.7, No.3, 2016
- [3] Jeff Hines,"an experiment on "BICYCLE GENERATOR PROJECT" 2011.
- [4] Billions in Change, says, "Free Electric bike generates electricity with pedal power", *Stu Roberts-December 18th, 2015*
- [5] free un-damped vibrations, "Polytec InFocus 1/2007" (PDF).
- [6] Kanak Gogoi, *Innovator and Inventor*

National Conference on Current Trends in Engineering, Science and Technology (NACCTEST- 2018)
 Organized by GF's Godavari College of Engineering, Jalgaon
International Journal of Innovations in Engineering and Science, Special Conference Issue, 2018
 www.ijies.net

A Review on Design Development of Interchangeable Tool Head and Auto-Feed Table Mechanism for Portable Orbital Form Riveter

P.P.Gawande¹, Tushar A Koli², Dr.V. H.Patil³

¹ Student

Godavari college of engineering, Jalgaon, Pin 425001

² Assistant Professor,

Godavari college of engineering, Jalgaon

³ Associate Professor

Godavari college of engineering, Jalgaon, Pin 425001

¹Email:- prasannagawande@gmail.com

Abstract—Riveting process is conventionally carried out using either a press machine, or manually hammering. This process is not accurate, takes considerable time and effort and so also may result into damage of component. The Portable orbital riveter uses the principle of orbital riveting where in a high speed spinning riveting tool held at an angle in the riveting head is fed into the rivet. This results in cold forming of the rivet head of maximum strength and with comparatively low force (less than 80% force that of conventional method) result into a strong and accurate joint. The angle of the riveting tool held in the riveting head plays a significant role in the reduction in forming force, where as the table motion will determine the accurate positioning of the rivet in to tool profile, resulting into exact shape and size of rivethead formed. Project deals with determination of optimal tool angle in tool head, and tool geometry and mechanism of table feed for accurate positioning. The portable orbital form riveting machine with optimal angle tool head and auto-positioning feed table will be designed and modeled using Unigraphics software, Analysis will be done using Ansys work bench 16.0. The rivet geometry dimensions(head diameter & depth),

clearance in hinge joint will be parameters for optimization of tool angle by using ANNOVA software.

Keywords- Interchangeable tool head.

INTRODUCTION

As we know, we are oftenly used small machine components joining together to form a larger machine part. Design of joints is as important as that of machine components because a weak joint may spoil the utility of a carefully designed machine part. Rivets are widely used in industrial applications for joining different machine components. Cracks developed on the rivet heads during their forming may lead to the failure of the entire machine. Hence it is very important to eliminate the formation of cracks. The possible reasons for this defect are improper tool design, machine fluctuations and improper material selection of the tool or rivet. In our effort to eliminate this problem redesigning the tool would be the most feasible and attractive option. Riveting process is conventionally carried out using either a press machine, or manually hammering. This process is not accurate, takes considerable time and effort and so also may result into damage of component.

National Conference on Current Trends in Engineering, Science and Technology (NACCTEST- 2018)
 Organized by GF's Godavari College of Engineering, Jalgaon
International Journal of Innovations in Engineering and Science, Special Conference Issue, 2018
 www.ijies.net

The Portable orbital riveter uses the principle of orbital riveting where in a high speed spinning riveting tool held at an angle in the riveting head is fed into the rivet. This results in cold forming of the rivet head of maximum strength and with comparatively low force (less than 80% force that of conventional method) result into a strong and accurate joint. The angle of the riveting tool held in the riveting head plays a significant role in the reduction in forming force, whereas the table motion will determine the accurate positioning of the rivet in to tool profile resulting into exact shape and size of rivet head formed

METHODS

The working of this machine is flexible and simple. The riveted job made this machine is best. Also it is less time consuming process. let's focus on machine process. Motor is started which rotates the main spindle at high speed. The tool or rivet set mounted in the tool holder rotates at high speed. The job to be riveted along with the rivet is placed in the work holder .The feed motor is operated to move in upward direction to lift the table slide and table in the table guide by means of roller arrangement.

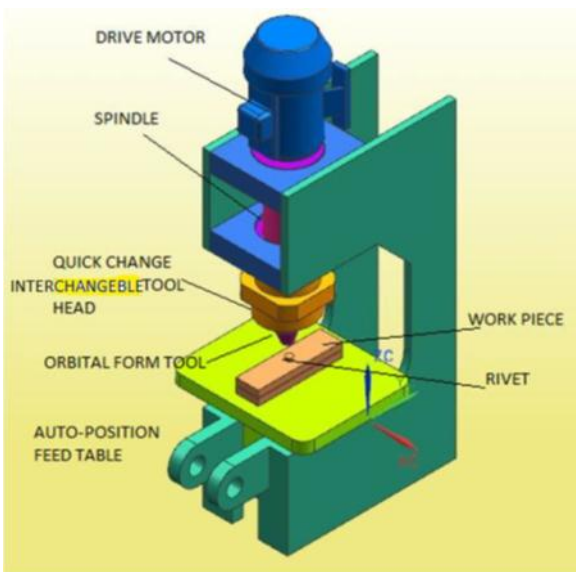

TABLE LIFTING MECHANISM

Geared motors with integrated worm gear box will be used to reduce the system weight and make it compact

The jack system will be designed to be with a auto-positioning circuit with help of limit switches. The motor will rotate the nut through gear arrangement, and screw will slide up or down to take the table up or down.

EMPIRICAL METHOD TO COMPUTE FORGING LOAD

A. OPEN DIE FORGING

The load required to forge a flat section in open dies may be estimated by;

$$P = \sigma A C . , N$$

A = Forging projected area; mm²

σ = mean flow, stress N/mm²

C = Constant (Constraint factor) to allow for in homogeneous deformation the deformation resistance increases with Δ which is defined as;

Δ = mean thickness of deforming zone / length of deforming zone = h/2L

Then C is given as;

$$C = 0.8 + 0.2 \Delta$$

INPUT DATA

MATERIAL OF RIVET

Designation on	Tensile Strength h (N/mm ²)	0.2% Proof Strength (N/mm ²)
5300	215	100

Δ = mean thickness of deforming zone / length of deforming zone = h/2L

$$= 3/2(4)$$

$$\Delta = 0.375$$

$$C = 0.8 + 0.2 \Delta$$

$$= 0.8 + 0.2 (0.375)$$

$$= 0.875$$

C = Constant (Constraint factor) = 0.875

σ = mean flow stress = 100 N/mm²

A = Forging projected area ; mm²

$$= \pi \times D^2 / 4$$

$$= \pi \times 32 / 4 = 7.06 \text{ mm}^2$$

$$P = \sigma A C$$

$$= 100 \times 7.06 \times 0.875$$

$$= 617.75 \text{ N}$$

National Conference on Current Trends in Engineering, Science and Technology (NACCTEST- 2018)
Organized by GF's Godavari College of Engineering, Jalgaon
International Journal of Innovations in Engineering and Science, Special Conference Issue, 2018
www.ijies.net

Most of the work during orbital forming is focused at the tool's line of contact, not along the entire tool surface. This reduces axial loads by as much as 80%, which has several advantages.

$$\text{Hence, } P_{\text{eff}} = 0.2 \times 617.75 =$$

$$123.5$$

$$P_{\text{eff}} = 124 \text{ N}$$

This is the load that acts in the downward direction while forming the rivet, whereas the rivet head diameter is 6mm, hence the torque required at the spindle is given by:

$$T = P_{\text{eff}} \times r$$

$$= 124 \times 3$$

$$= 372 \text{ N-mm}$$

$$T = 0.372 \text{ N-m}$$

Power required at spindle is given by ,

$$P = 2 \pi N T / 60$$

$$= 2 \pi \times 900 \times 0.372 / 60$$

$$= 70 \text{ watt}$$

Considering 100 % overload

$$\text{Power at spindle} = 140 \text{ watt}$$

Thus motor of 150 watt will be sufficient for the operation .

results in weaker section being developed on the rivet head. This machine reduces transportation and operation time and increases the efficiency as well as accuracy of the product. This machine is very useful in industry as it reduces time constraint also it increases the Productivity.

ACKNOWLEDGEMENT

The project was supported by management of JSPM's ICOER. We thank to our colleagues from ICOER who provided insight and expertise that greatly assisted research. We also show gratitude to Prof. U.S. Gawai for Sharing their pearl of wisdom with us during course of this project. We thank to Sagar Sir who is our industrial guide for guiding us through out of the year which made this project successful at the end. We also thanks to Paramount Industries which is sponsor for this project, To giving us opportunity to work on this live project. We are thankful to our institution and faculty members without whom this project would have not been a completed.

REFERENCES

- [1] T. A. Patil, Asst. Prof P. N. Ulhe², and P. D. Bhojar³ (Analysis & Design of drilling cum orbital riveting machine.)
- [2] Prof. K. G. Sontakke, Prof. R. D. Vaidya, and Prof. D. M. Mate (Design and Analysis of Drilling Cum Riveting Machine)
- [3] K. H. Salián, P. S. Sanku, S. P. Shah, and U. A. Shaikh (Elimination of Cracks Formed on Rivet Head)
- [4] P. N. Ulhe, Asst prof s.s.b.t.coe, Jalgaon. (Analysis & Design of drilling cum orbital riveting machine.)
- [5] S. K. Jagtap, M. Kavade (Orbital riveting—a desine and Development of new machine)
- [6] G. Hanssen, R. Porcaro, M. Langseth, and A. Aalberg, (" The behavior of a selfpiercing riveted connection under quasi-static loading conditions",)

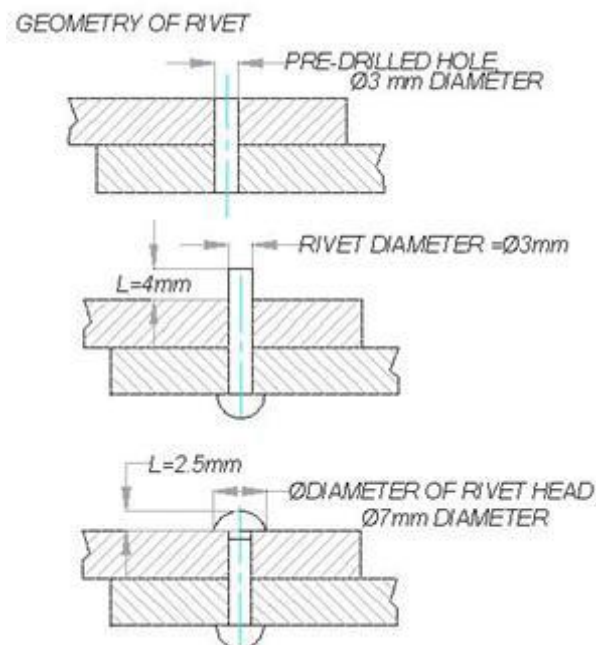

CONCLUSION

In this project we have conclude that this machine works safely and fulfill the actual condition required for machining operations like drilling and riveting. Tool depth, Tool Dimension, Radius of Curvature exceeds

National Conference on Current Trends in Engineering, Science and Technology (NACCTEST- 2018)
Organized by GF's Godavari College of Engineering, Jalgaon
International Journal of Innovations in Engineering and Science, Special Conference Issue, 2018
www.ijies.net

Solar Powered Water Dispenser

¹ Darshan Patil , ² Mayur Patil , ³ Vishnu Shirsagar , ⁴ Apurva Nemade , ⁵ Gaurav kolte

⁶ MaheshPatil

^{1,2,3,4,5} Students, ⁶ Assistant Professor

¹²³⁴⁵⁶ Electrical engineering

¹²³⁴⁵⁶ GF's Godavari College of Engineering, Jalgaon, India, 425001

⁶ mhpatils@gmail.com

Abstract – The present water cooling methods are evaporative coolers, compressor, fans and dehumidifiers. But running these products need a source called electricity. The producing of electricity is ultimately responsible for hot and humid conditions i.e. global warming. In hot and humid conditions the need to feel relaxed and comfortable has become one of few needs and for this purpose utilization of systems like refrigeration has increased rapidly. These systems are most of the time not suitable for villages due to longer power cut durations and high cost of products. Solar power systems being considered as one of the path towards more sustainable energy systems, considering solar-cooling systems in villages would comprise of many attractive features. This technology can efficiently serve large latent loads and greatly improve water cooling quality by allowing more ventilation while tightly controlling humidity. Despite increasing performance and mandatory energy efficiency requirements, peak electricity demand is growing and there is currently no prevalent solar air cooling technology suited to residential application especially for villages, schools and offices. This project reviews solar powered air cooler for residential and industrial applications

Keywords- solar energy, solar inverter, water cooler dispenser

INTRODUCTION

This paper reveals the comfort conditions achieved by the device for the human body. In summer (hot) and humid conditions feel uncomfortable because of hot or normal water . So it is necessary to maintain thermal comfort conditions. Thermal comfort is determined by

the drinking cold water. comfort. Relative humidity (RH) is a measure of the moisture in the water, compared to the potential saturation level. Warmer water can hold. When you approach 100% cooling The hot normal water in a building is based on the outside temperature and sun loading plus whatever heating or cooling is added by the HVAC or other heating and cooling sources.. Need of such a source which is abundantly available in nature, which does not impose any bad effects on earth. There is only one thing which can come up with these all problems is solar energy.

PRESENT PROBLEM

The producing of electricity is ultimately responsible for hot and humid conditions i.e. global warming. As in below shown chart it is clear that major quantity of electricity is produced by coal (fossil fuel).

Fossil fuels also contain radioactive materials, mainly uranium and thorium, which are released into the atmosphere, which contribute to smog and acid rain, emit carbon dioxide, which may contribute to climate change. Longer power cut durations in villages and high cost of cooling products.[4]

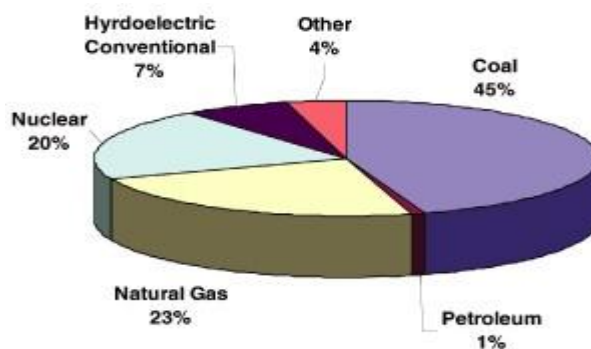

Fig.1 Production of electricity from different sources

PROPOSED SOLUTION

Need of such a source which is abundantly available in nature, which does not impose any bad effects on earth. There is only one thing which can come up with these all problems is solar energy.

OBJECTIVE THE PROJECT

To make aware of non-conventional energy sources to reduce environmental pollutions. To provide solution for power cut problems in villages. To replace existing costlier and high energy consumption cooling methods. [4]

METHODOLOGY

This project mainly consist of two sections:

1.Solar Energy Conversion

Solar energy conversion is done by using battery, inverter and charge controller. As sun light falls on solar panel, which converts into electrical energy by photoelectric effect. This electrical energy stored in battery in the form of chemical energy. Charge controller is employed in between solar panel and battery which prevents overcharging Figure of Solar energy conversion process and may protect against overvoltage, which can reduce battery performance or lifespan, and may pose a safety risk. The stored energy directly can use for DC loads or else need to be converted AC (alternate current) by the help of inverter.[4]

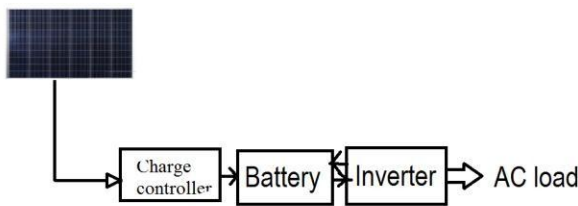

Fig.2.fig shows solar energy conversion process

2. Water cooling dispenser

The converted energy is used to run the water refrigerator . This compressor covered with coolant, through which water is passed at a specific rate. As the fan sucks the hear of water through coolant , heat transfer occur between coolant and water thus generated cold water comes through cold water outlet.[4]

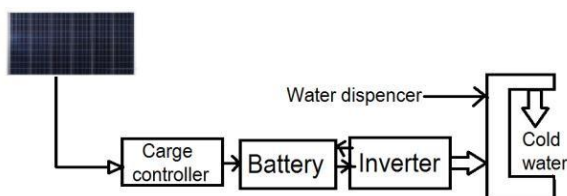

Fig.3 Solar powerd water cooling systel

WORKING MODEL OF PROJECT IN IMPLEMENTATION

This concept is driven by solar energy. Components involved in this concept are solar panel, battery, charge controller, battery, inverter, blower, ceramic slabs and cooling pads. Solar panel is employed to convert sun light into electrical energy by means of photovoltaic effect. The generated electrical energy is supplied to the battery for storage purpose through charge controller which prevents from power fluctuations. As AC blower is used for cooler, so need to convert DC load from the battery to AC load by the help of inverter. Inverter converts DC load to AC. Load, now AC power can be supplied to the blower. This water cooler dispencer is surrounded by cooling pads through which continuous water supply is provided. When the water cooler dispencer is switched on, water cooler dispencer water from can and it cools , so the cold water comes through tab.[4]

DESIGN

Capacity Solar Panel and Battery required

Hence selected water cooler dispencer Specification:

230v,0.6A,65w,50hz

So to run 65W solar water dispencer on for 1 hour will take

$35 \times 1 = 35\text{Wh}$ from the battery (Battery capacity is measured in Amp hours)

For 100Ah, 12v battery the watt hours is given by

$$P = V \times I$$

$$V = 12\text{v and } I = 100\text{Ah}$$

$$P = 100 \times 12 = 1200\text{Wh}$$

So, the 65W centrifugal fan runs for

$$1200 / 65 = 18.46 \approx 18\text{h}$$

This means the battery could supply 65W blower for 18 hours

To calculate the energy it can supply to the battery, multiply watts by the hours exposed to sunlight, then multiply the result by 0.85(This factor allows for natural system losses)

For the solar 40W panel in 10 hours sunshine,

$$100 \times 10 \times 0.85 = 850\text{ Wh}$$

$$\text{For 1 hour, } 100 \times 1 \times 0.85 = 85\text{Wh}$$

So the solar panel of 100W and battery of 100Ah are selected (Office purpose).

[4]

National Conference on Current Trends in Engineering, Science and Technology (NACCTEST- 2018)
Organized by GF's Godavari College of Engineering, Jalgaon
International Journal of Innovations in Engineering and Science, Special Conference Issue, 2018
www.ijies.net

CONCLUSION

Comparing the cost of this product with the existing products in the market is solar product appeals better and affordable by common people. This solar product perfectly suits for villages, schools and offices and thus an alternate to the power cut problems. It comprises of many attractive features such as usage of solar energy, water cooler dispenser at lower cost. It is eco friendly and natural, totally electricity savers. Durability of the product is more thus minimizing the cost. No electricity is used so this product saves the energy and saves environment from getting polluted.

ACKNOWLEDGMENT

The authors acknowledge the contributions of the students, faculty of gf's godavari College of Engineering for helping in the design and fabrication of the dispenser and for tool support. The authors also thank the anonymous reviewers for their thoughtful comments that helped to improve this paper. The authors would like to thank the anonymous reviewers for their constructive critique from which this paper has greatly benefited.

REFERENCES

- [1] Farhan a. khmamas, 2012, "Improving the environmental cooling for air-coolers by using the indirect-cooling method" ARPN journal of engineering and applied sciences, vol. 5, No. 2, page No. 66-73.
- [2] A S Alosaimy, 2013 "Application of Evaporative Air Coolers Coupled With Solar Water Heater for Dehumidification of Indoor Air" International Journal of Mechanical & Mechatronics Engineering, Vol:13 No:01 page no. 60- 68.
- [3] "Basic Photovoltaic Principles and Methods" SERI/SP-290-1448 Solar Information Module 6213 Published February 1982 page. No. 9-15.
- [4] Vijaykumar Kalwa, June 2014, Design and development of solar powered air cooler , volume3 Issue6 , International Journal of Science and Research (IJSR) ISSN (Online): 2319-7064 Impact Factor (2012): 3.358 page no.478-481, Paper ID-02061402
- [5] Arora and Domkundwar, A text book "The course on power plant engineering".
B. Srinivas Reddy, K Hemachandra Reddy, "Thermal engineering data hand book"

National Conference on Current Trends in Engineering, Science and Technology (NACCTEST- 2018)
 Organized by GF's Godavari College of Engineering, Jalgaon
International Journal of Innovations in Engineering and Science, Special Conference Issue, 2018
www.ijies.net

Automatic Power Factor Correction

Sachin Maheshri¹, Sonu Warkhade², Sagar Chaudhari³, Diptee Patil⁴, Harshal Pawar⁵

¹ Assistant Professor Of Electrical Department

^{2,3,4} Student, Electrical Department

GF's Godavari College of Engineering, Jalgaon, India, 425003

sachinmaheshri@gmail.com

Abstract –In the present technological revolution power is very precious. So we need to find out the causes of power loss and improve the power system. Due to industrialization the use of inductive load increases and hence power system losses its efficiency. So we need to improve the power factor with a suitable method. Whenever we are thinking about any programmable devices then the embedded technology comes into force front. The embedded is now a day very much popular and most the product are developed with Microcontroller based embedded technology. Automatic power factor correction device reads power factor from line voltage and line current by determining the delay in the arrival of the current signal with respect to voltage signal from the function generator with high accuracy by using an internal timer. This time values are then calibrated as phase angle and corresponding power factor. Then the values are displayed in the 2X16 LCD modules. Then the motherboard calculates the compensation requirement and accordingly switches on different capacitor banks. This is developed by using 8051 microcontroller.

Keywords- Microcontroller, LCD display module, Capacitor bank, SCR, Optocoupler, Transformers, Voltage regulator

INTRODUCTION

Unlike Director Current Circuits, where only resistance restricts the current flow, in Alternating Current Circuits, there are other circuits aspects which determines the current flow; though these are akin to resistance, they do not consume power, but loads the system with reactive currents; like D.C. circuits where the current multiplied by voltage gives watts, here the same gives only VA.

Like resistance, these are called "Reactance". Reactance is caused by either inductance or by capacitance. The current drawn by inductance lags the voltage while the one by capacitance leads the voltage. Almost all industrial loads are inductive in nature and hence draw

lagging wattles current, which unnecessarily load the system, performing no work. Since the capacitive Currents is leading in nature, loading the system with capacitors wipes out them. The power factor of an AC electric power system is defined as the ratio of the real power flowing to the load to the apparent power in the circuit, and is a dimensionless number between 0 and 1 (frequently expressed as a percentage, e.g. 0.5 Pf = 50% Pf). Real power is the capacity of the circuit for performing work in a particular time. Apparent power is the product of the current and voltage of the circuit. Due to energy stored in the load and returned to the source, or due to a non-linear load that distorts the wave shape of the current drawn from the source, the apparent power will be greater than the real power. In an electric power system, a load with a low power factor draws more current than a load with a high power factor for the same amount of useful power transferred. The higher currents increase the energy lost in the distribution system, and require larger wires and other equipment. Because of the costs of larger equipment and wasted energy, electrical utilities will usually charge a higher cost to industrial or commercial customers where there is a low power factor.

Linear loads with low power factor (such as induction motors) can be corrected with a passive network of capacitors or inductors. Non-linear loads, such as rectifiers, distort the current drawn from the system. In such cases, active or passive power factor correction may be used to counteract the distortion and raise the power factor.

The devices for correction of the power factor may be at a central substation, spread out over a distribution system, or built into power-consuming equipment.

METHODOLOGY

Power factor is a ratio of real power and apparent power. Ideal power factor is unity. Pure resistive loads have unity power factor. But there is no such load exist. So we always try to make power factor close to unity reactive power is also reason of low power factor. Inductive loads absorb reactive power and capacitive loads provide reactive power.

National Conference on Current Trends in Engineering, Science and Technology (NACCTEST- 2018)
Organized by GF's Godavari College of Engineering, Jalgaon
International Journal of Innovations in Engineering and Science, Special Conference Issue, 2018
www.ijies.net

So capacitor banks are used to improve power factor in power factor correction circuit.

By connecting capacitor banks parallel to load, power factor is increased. Capacitor provides reactive power locally to load instead of getting from power system which in return induces burden in power supply. This is main objective of automatic power factor controller. An inductive load having a low power factor requires the power supply to pass reactive current with associated power losses and exaggerated voltage drops, as noted in the nature of reactive power.

If a bank of shunt capacitors is added to the load, its (capacitive) reactive current will take the same path through the power system as that of the load reactive current. Since, as pointed out in the nature of reactive power, this capacitive current I_c is in direct phase opposition to the load reactive current (I_L). The two components flowing through the same path will cancel each other, such that if the capacitor bank is sufficiently large and $I_c = I_L$, there will be no reactive current flow in the system upstream of the capacitors.

DESIGN

Theoretically design

I. Power Supply design

Power supply is the most important part of the project. For project +5V regulated power supply with maximum current rating 500mA. Following basic building blocks are required to generate regulated power supply.

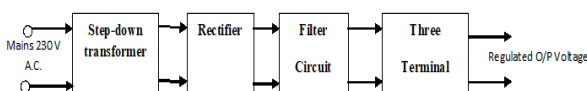

Fig.1 Regulated power supply

ii. Design of transformer

Step down transformer is the first part of regulated power supply. To step down the mains 230V A.C. we require step down transformer. Following are the main characteristic of electronic transformer.

- 1) Power transformers are usually designed to operate from source of low impedance at a single freq.
- 2) It is required to construct with sufficient insulation of necessary dielectric strength.
- 3) Transformer ratings are expressed in volt-amp. The volt-amp of each secondary winding or

windings is added for the total secondary VA. To this are added the load losses.

- 4) Temperature rise of a transformer is decided on two well-known factors i.e. losses on transformer and heat dissipating or cooling facility provided unit.

III. Rectifier Design

R.M.S. Secondary voltage at secondary of transformer is 12V.

So maximum voltage V_m across Secondary is

$$\begin{aligned} &= \text{Rms. Voltage} \times \sqrt{2} \\ &= 12 \times \sqrt{2} \\ &= 16.97 \end{aligned}$$

D.C. O/p Voltage at rectifier O/p is 2 V_m

$$\begin{aligned} V_{dc} &= 2V_m / \pi \\ &= 2 \times 16.97 / \pi \\ &= 10.80 \text{ V} \end{aligned}$$

PIV rating of each diode is,

$$\begin{aligned} \text{PIV} &= 2 V_m. \\ &= 2 \times 16.97 \\ &= 34 \text{ V} \end{aligned}$$

Maximum forward current which flow from each diode is 500mA. So from above parameter we select diode IN 4007 from diode selection manual.

IV. Design of Filter Capacitor

Formula for calculating filter capacitor is,

$$C = 1/4\sqrt{3} r f R_L.$$

r = ripple present at o/p of rectifier. (This is maximum 0.1 for full wave rectifier.)

F = frequency of mains A.C.

R_L = I/p impedance of voltage regulator IC.

$$\begin{aligned} C &= 1/4\sqrt{3} \times 0.1 \times 50 \times 28 \\ &= 1030 \mu\text{f} \\ &\cong 1000 \mu\text{f} \end{aligned}$$

Voltage rating of filter capacitor is double of V_{dc} i.e. rectifier o/p which is 20V. So we choose 1000 μf / 25V filter capacitor.

IC7805 (Voltage Regulator IC)

i. Specifications:

- 1) Available o/p D.C. Voltage = + 5V.
- 2) Line Regulation = 0.03
- 3) Load Regulation = 0.5
- 4) V_{in} maximum = 35 V
- 5) Ripple Rejection= 66-80 (dB)

CALCULATION

Observation table after getting the power factor readings on each loads.

National Conference on Current Trends in Engineering, Science and Technology (NACCTEST- 2018)
Organized by GF's Godavari College of Engineering, Jalgaon
International Journal of Innovations in Engineering and Science, Special Conference Issue, 2018
www.ijies.net

Sr. No.	Load In Watt	Current	Voltage	Timing In Mili Second	P.F. Correction
1.	60	Lead	Lag	1 to 2	0.80
2.	75	Lead	Lag	2 to 3	0.81
3.	75	Lead	Lag	3 to 4	0.61
4.	100	Lead	Lag	1 to 2	0.61
5.	100	Lead	Lag	3 to 4	0.32
6.	115	Lead	Lag	2 to 3	0.63
7.	120	Lead	Lag	2 to 3	0.61
8.	160	Lead	Lag	2 to 3	0.63
9.	175	Lead	Lag	2 to 3	0.64

PROJECT MODEL

Project

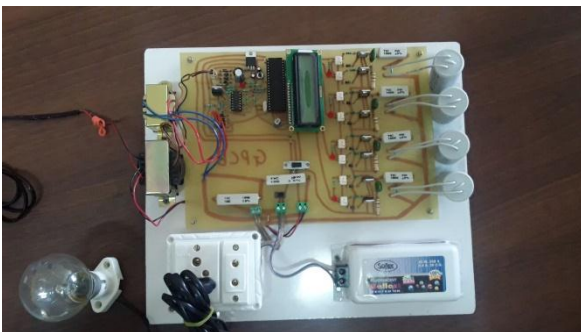

PROJECT MODEL

Capacitor Bank with resistors



Capacitor bank and the resistors used in project

Transformers

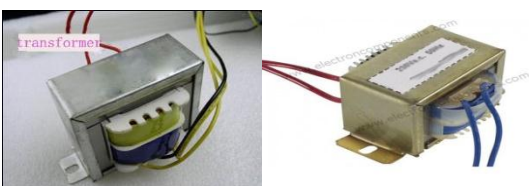

Current transformer and the potential transformer

CONCLUSION

It can be concluded that power factor correction techniques can be applied to the industries, power systems and also house hold to make them stable and due to that the system becomes stable and efficiency of the system as well as the apparatus increases. The use of microcontroller reduces the costs. Due to use of microcontroller multiple parameters can be controlled and the use of extra hard wares such as timer, RAM, ROM and input output ports reduces. Care should be taken for overcorrection otherwise the voltage and current becomes more due to which the power system or machine becomes unstable and the life of capacitor banks reduces.

ACKNOWLEDGMENT

We are the students of GF'S Godavari College of Engineering Jalgaon of electrical branch. We express our gratitude to college Dr. V.G. ArajpureprincipalGF'sGodavariCollege of Engineering Jalgaon for arranging the summer training in good schedule. We also extend our gratitude to my project guide Electrical Department, who assisted us in compiling the project. We would also like to thank all the faculty members of for their critical advice and guidance without which this project would not have been possible. Last but not the least we place a deep sense of gratitude to our friends who have been constant source of inspiration during the preparation of this project work.

REFERANCE

- [1]ZhiguoPan(Jan 2005), *Power Factor Correction Using a Series Active Filter*. Student Member, IEEE, Fang Z. Peng, Fellow, IEEE, and Suilin Wang
- [2] Paul NosikeEkemezie(2007),*Design Of A Power Factor Correction AC-DC Converter*. IEEE conference publications
- [3] O. Garcia, J. A. Cobos, R. Prieto, P. Alou, and J. Uceda(2001), *Power factor correction: A survey in Proc. IEEE Annu. Power Electronics Specialists Conf. (PESC'01)*, , pp. 8–13
- [4] J. Itoh and K. Fujita(1999), *Novel unity power factor circuits using zero-vector control for single phase input system*, in Proc. IEEE Applied Power Electronics Conf. (APEC'99), pp. 1039–1045
- [5]<http://microcontrollerslab.com/automatic-power-factor-controller-using-pic-microcontroller/>

National Conference on Current Trends in Engineering, Science and Technology (NACCTEST- 2018)

Organized by GF's Godavari College of Engineering, Jalgaon

International Journal of Innovations in Engineering and Science, Special Conference Issue, 2018

www.ijies.net

Solar Based Grass Cutter Machine

Sachin Maheshri¹, Ritesh Patil², Hemant Avasrma³, Shubham Bhad⁴

¹ Assistant Professor Of Electrical Department

^{2,3,4} Student, Electrical Department

Gf'S Godavari College of Engineering, Jalgaon, India, 425003

1) rdpatil1803@gmail.com 2) shubhambhad76@gmail.com

Abstract – In today's generation the major problems are the pollutions, cut of power etc. Thus overcome to these problems we have thought about device which can be work efficiently without causing any types of problem. So we work on the project of grass cutter machine which performing fully automated and using renewable source of energy that is solar power. The main object of this project is to invent solar operated grass cutting machine which is operated on the solar power. There is power shortage therefore we decide to work on the device which operated on solar power. And if the somecondition there is solar power will be not done we use the external power supply, for that we make the external power supply circuit. This project working is easy and simple in construction. In this project we use the solar panel which is connected to the battery where the battery supplies the power to the whole arrangement. In this project we connect the four motors where the two motors for moving action and other two motors for the cutter blades. So from this paper we present the daily purpose robot which cuts the lawn.

Keywords-Solar Plate, Battery,Blades, Atmega8 Microcontroller, Sensors, DC Motor, Voltage Regulator, Sensor.

INTRODUCTION

Solar energy is the form of renewable energy source and this source is characterized as either passive solar or active solar depending on how they capture and distribute solar energy or convert it into solar power. Basically solar energy is the free energy source which can be used easily. Then by using this free solar energy, solar based grass cutter machine will be operating automatically. Generally in the market there are many grass cutter machines are available like electrical and gasoline based. The gasoline grass cutter machine fully depends on the fuel means it works on the fuel which increases the air pollution. And the electrical grass cutter

machine fully depends on the electricity provide by the electrical motor that is induction motor.

For this cutter machine long wire required for the power supply and due to the high weight of induction motor, it is difficult to operate. If think about these problems, try to make grass cutter machine on fully automated based on the solar power. In this project the 10 watt solar panel used for the power supply and 12V battery used for storing the solar power.

There are four motors are used which are controlled by the Atmega8 microcontroller. Where the two motors are used for the moving action and the other two motors used for grass cutting purpose. For avoiding the obstacles during the operation the ultrasonic sensor is used for avoiding action. There is no need of fuel and any wire extension for the power supply therefore it is pollution less and eco-friendly project.

METHODOLOGY

The solar panel mounted on the grass cutter machine receives the solar power from the sun. This solar power stored in the battery. The battery provides power supply by using the solar charge controller. The main function of the solar charge controller is to increase the current from the panels while batteries are charging, it also disconnects the solar panels from the batteries when they are fully charged and also connects to the panels when the charging in batteries is low [2].

The solar grass cutter machine is start operation by the switch connected on the board which allows the flow of current to the motor which in turn drive the blades used for moving[5]. In this solar grass cutter machine the four dc 12v motors are connected to the both side of the machine, per side two motors are connected in parallel connection so they works as a single unit on both side[1]. Other additional motors are connected at the

National Conference on Current Trends in Engineering, Science and Technology (NACCTEST- 2018)
Organized by GF's Godavari College of Engineering, Jalgaon
International Journal of Innovations in Engineering and Science, Special Conference Issue, 2018
www.ijies.net

front of the frame; these motors have connected blades on the motor shaft so that the grass is cut by turn on these motors. These motors are operated by the Atmega8 micro-controller; it gives the forward moving command to the motors. During the operation of this grass cutter if the obstacle comes in front of machine the Atmega8 micro-controller give the command to the SR04 ultrasonic sensor and this sensor detect that obstacles and avoid them and change the direction of grass cutter machine. The components used in this project are 12V 10watt solar panel, 12V battery, LM7805 voltage regulator, Atmega8 micro-controller, SR04 ultrasonic sensor, DC motors.

I. Block Diagram

The block diagram show in the below is present the constructional block diagram and the required components to the solar grass cutter machine.

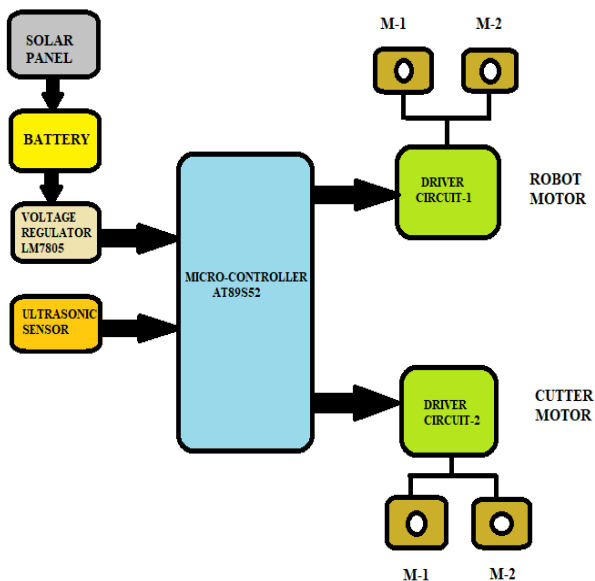

Fig.1 Block diagram of solar grass cutter machine

In the above constructional block diagram, the solar panel mounted on the battery where the battery charge by the solar power which captured from the solar panel. There are LM7805 voltage regulator connected to the battery which generate the fixed output voltage to micro-controller. The two motors connected to the driver circuit and the blades connected to the other two motors that is cutter motors.

Components used in this project are as follows:

I. Solar Panel:

The typical 12V 10 watt 6x10 solar panel is used in this project. The solar panel can be used as a component of a larger photovoltaic system to generate and supply electricity in commercial and residential applications [2]. In order to run a mechanism the motor required 12 volt. And Variable current so that we are storing that power in to battery in order to run the mechanism.

Our battery capacity is 12 volt and 7.5 amps.

Hence power is calculated by = Voltage*current
= 12*7.5

=90 watt (In a single battery)

In order to store this much of power in battery we required time.

Total battery power =Power generation of panel per hour*Time

Hence 90watt. =10*Time

Time=9 Hour [5]



Fig. 2 Solar panel

The specification of this solar panel are;

- 1) AP Monocrystalline Blue Solar Cell
- 2) Peak Voltage (V_{mp}): 12V
- 3) Open Circuit Voltage (V_{OC}): 6.0V - 6.8V
- 4) Peak Current (I_{mp}): 400mA
- 5) Short Circuit Current (I_{sc}): 400mA - 432mA
- 6) Maximum Power (P_{max}): 2.5W [1]

II. Atmega8 micro-controller :

The micro-controller used in this project is Atmel AT89S52 microcontroller. This micro-controller is a powerful microcontroller which provides a highly-flexible and cost-effective solution to many embedded control applications.

National Conference on Current Trends in Engineering, Science and Technology (NACCTEST- 2018)
 Organized by GF's Godavari College of Engineering, Jalgaon
International Journal of Innovations in Engineering and Science, Special Conference Issue, 2018
 www.ijies.net

The AT89S52 micro-controller provides the following standard features:-

- 1) 8K bytes of Flash
- 2) 256 bytes of RAM, 32 I/O lines
- 3) Watchdog timer
- 4) Two data pointers
- 5) Three 16-bit timer/counters
- 6) A six-vector two-level interrupt architecture
- 7) A full duplex serial port
- 8) On-chip oscillator
- 9) Clock circuitry.

III. DC motors:

The 12V permanent magnet dc motors are used in this project. If the current carrying conductor placed in the magnetic field, it cuts the magnetic field and produce magnetic flux. It experiences the torque and the tendency of moving action therefore it has called as motoring action.



Fig.3 dc motor

IV. LM7805 voltage regulator:

Here the three terminal voltage regulator are used for the stable dc voltage. The LM7805 is the three terminal positive regulators available in the TO-220 package and with several fixed output voltages, making them useful in a wide range of application. Depending on the design, it may be used to regulate one or more AC or DC voltages. Any difference is amplified and used to control the regulation element. [1]

V. Power Supply:

The designed power supply is made up of solar panel, which gives 12V 10W as output. This 12v output is capable of running motors, relays blades and pumps. All the other circuitry is given a regulated voltage of +5V. [1]

VI. Ultrasonic sensor:

The sensor used in this project is SR04 ultrasonic sensor for detection of the obstacles. This device generates the ultrasound waves by using the electrical energy. It also converts ultrasound vibrational energy into electrical signals. Normally in the ultrasound switches the barium titanate transducer applying piezoelectric effect is used.



Fig.4 Ultrasonic sensor

VII. Circuit Diagram

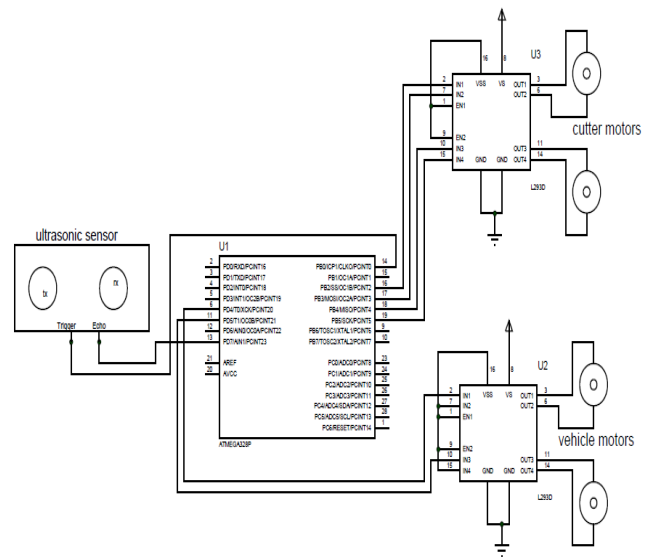

Fig.5 Circuit Diagram Of The System

This circuit is implemented by making use of the transformer (220V/12V), Rectifier, Filter, Voltage regulator, Comparator, Transistor and Relays. The selection of equipment with proper rating is done by calculating their minimum and maximum rating of voltage and current across them under normal as well as abnormal operating conditions and proper care is taken in selection of the transformer as it is acting like interface between the electrical and electronics circuit used. The protection of delicate ICs must be ensured.

DESIGN ANALYSIS

Theoretical

I. General analysis:

The shearing force of most annual and perennial grasses found on most lawns is usually between 9.2N ~ 11.51N (Yong and Chow, 1991)[3].

Force required by cutting blade to shear the grass is given by;

$$F = T/R \dots\dots\dots (1)$$

Where T = Shaft torque; R = Radius of cutting blade
 But shaft torque is given by;

$$T = P/2\pi N \dots\dots\dots (2)$$

Where P = Power developed by shaft; T = Torque required; and N = Shaft speed in Rev/min [3].

II. Power Transmission

Power transmitted from the motor to the blade is given by;

$$P = (T1 - T2) v$$

(Khurmi, 2003)

Where T1 = Tension on tight side of belt
 T2 = Tension on slack side of belt, and P = 932.5 N
 Use was made of group A, v-belt design having a power transmission range of 0.7 ~ 3.5 kW.

$$2.3 \log (T1/T2) = \mu\theta \text{cosec}\beta$$

(Khurmi, 2003)

$\text{Sin}\alpha = (R1 - R2) / C = (60 - 40) / 180 = 0.1111; \alpha = 6.38^{\circ}$
 Where R1 and R2 are rad. of pulleys 1 and 2 respectively.

Angle of contact,
 $\theta = 180 - 2\alpha = 180^{\circ} - 2(6.38) = 167.24^{\circ}$
 $\theta = 167.24^{\circ} (\pi/180^{\circ}) = 2.92 \text{ rad.}$
 $2.3 \log (T1/T2) = \mu\theta \text{cosec}\beta;$
 where $\mu = 0.2$ and $2\beta = 34^{\circ}$

Thus, $T1/T2 = 7.379; T1 = 7.379T2$

$$P = (T1 - T2) v ;$$

where P and v are transmitted power and peripheral velocity respectively.

$$932.5 = (T1 - T2) \times 15.71$$

$$T1 - T2 = 59.36 \text{ N}$$

$$7.379T2 - T2 = 59.36;$$

$$T2 = 9.3\text{N and } T1 = 68.66\text{N}$$

Centrifugal tension in the belt is given by;

$$T_c = mv^2$$

where m = mass of belt per meter, and v = peripheral velocity.

$$T_c = (1.06/9.81) \text{ kg/m} \times 15.71^2 = 26.67\text{N}$$

[3].

III. Power Selection

The force required to cut grass by a sharp object should not be less than 10Newtons, this is subjected by factors such as: the height of the grass, type as well as grass density in the area. However a slightly bigger force will be required (or selected) for high efficiency.

Considering the blade in concept three;

$$\text{Area of blade} = 0.24\text{m}^2$$

$$\text{Volume of blade} = \text{Area of blade} \times \text{Thickness}$$

$$= 0.00176\text{m}^3$$

$$\text{Density} = \text{mass/volume}$$

$$= 1001.7 \text{ kg/m}^3$$

$$\text{Thus, Mass of blade} = 1.763\text{kg};$$

$$\text{Force} = 1.763 \times 9.81 = 17.295\text{N}$$

$$\begin{aligned} \text{Torque required to turn the blade} &= \text{Force} \times \text{Radius of blade} \\ &= 17.295 \times 0.331 \\ &= 5.725 \text{ Nm} \end{aligned}$$

Thus, depending on the density of grass, the minimum power required to move the blade in 1 second is 1.8Watts. Tanimola, et al (2014). This is quite a small value, but it plays an important role in selecting the power needed. According to Tanimola, et al (2014), the greater the power, the greater the efficiency. Hence, considering the power required to move the blade. [6]

National Conference on Current Trends in Engineering, Science and Technology (NACCTEST- 2018)
Organized by GF's Godavari College of Engineering, Jalgaon
International Journal of Innovations in Engineering and Science, Special Conference Issue, 2018
www.ijies.net

The strength and density of grass as well as efficiency and factor of safety in design, 2.1 kW is selected. This will be able to handle different types of grass at expectedly high efficiency. [6]

IV. Design of Blades

In order to cut the grass the peripheral speed of the blade was calculated by the formula,

$$V = \pi d N$$

60

Where,

V= blade speed, m/s; d = diameter of cutting area.

N = shaft speed, rpm. [4]

PROJECT IMPLEMENTATION PICTURE



CONCLUSION

This project provides a design method of an automated grass cutter operated on solar power, whose task is to cut grass with no need of user interaction. This task is expected to be made possible by using sensors to provide an arduino with controlling.

The obstacle is automatically avoided; here for obstacle avoidance the ultrasonic sensor is used. The system also provides power backup by using inverter. The proposed system will be cost efficient with higher reliability.

ACKNOWLEDGMENT

I has been sincere desire of every individual to get an opportunity to express his views, skills, attitude and talent in which his proficient to give his satisfaction and confidence in his ability to do or produce something useful for humankind. A project is one such avenue through which an engineer gives vent to his feeling and expressions.

We wish to thank our project guide PROF. SACHIN MAHESHRI (Asst. prof. of electrical dept.) for his valuable suggestion and inspiring guidance. We are thankful to honorable Principal DR. V.G.ARAJPURE for their precious time whenever we wanted any help from them. They are also helpful in giving professional ideas and technical references.

We also express deepest thanks to HOD of electrical dept. PROF. ATUL BARHATE & staff members concerned who have meticulous planning created a comfortable co-existence of the projects and college schedule.

Last but not least we are also thankful to our friends who gave us their help and great co-operation to make our project successful directly and indirectly.

REFERENCES

- [1] *International Journal on Recent and Innovation Trends in Computing and Communication* ISSN: 2321-8169 Volume: 4 Issue: 3.
- [2] *International Journal of Research in Advent Technology (IJRAT) (E-ISSN: 2321-9637) Special Issue National Conference CONVERGENCE 2016*, 06th-07th April 2016.
- [3] *International Journal of Engineering and Technology* Volume 3 No. 10, October, 2013 ISSN: 2049-3444 © 2013 – IJET Publications UK. All rights reserved. 933 “ Simple Design of Self-Powered Lawn Mower
- [4] *International Journal of Agriculture Sciences* ISSN: 0975-3710&E-ISSN: 0975-9107, Volume 9, Issue 40, 2017, pp.-4638-4641
- [5] *International Journal For Technological Research In Engineering* Volume 3, Issue 10, June-2016 ISSN (Online): 2347 – 4718
- [6] *Elk Asia Pacific Journal Of Mechanical Engineering Rresearch Issn 2394-9368 (Online); Eapjmer/Issn. 2394-9368/2016; Volume 2 Issue 1 (2016).*

National Conference on Current Trends in Engineering, Science and Technology (NACCTEST- 2018)
Organized by GF's Godavari College of Engineering, Jalgaon
International Journal of Innovations in Engineering and Science, Special Conference Issue, 2018
www.ijies.ne

GSM Based Three Phase Induction Motor Protection and Control

ShubhamChaudhari¹, GirishMali², Mahesh Kasar³, Amar Bagul⁴, AtualBarahate⁵

^{1,2,3,4}Student, ⁵Assistant Professor
^{1,2,3,4,5}Electrical engineering

^{1,2,3,4,5}GF's Godavari College of Engineering, Jalgaon, India, 425001
atbarhate@gmail.com

Abstract –This paper provides embedded based solution for a protection and control of three phases Induction Motor. The proposed system is able to protect motor from various electrical faults like under voltage over voltage overheating and single phasing also as well as this system is also able to control three phase induction motor from 1m mobile phone by using GSM module. The basic idea for the development of this system is to control induction motor from remote areas to make agriculture water pumps more user friendly and to provide safety to motors installed in various industrial application. When any of the mentioned faults occurred in system corresponding relay will trip and motor is detached from fault condition. This system developed by using components like 8051 microcontroller GSM module temperature sensor relay LM-339 OP-AMP etc.

Keywords- Microcontroller, under-over voltage, overheating, GSM module etc.

INTRODUCTION

Nowadays three phase ac motors are widely used in many industrial applications due to many advantages associated with it like easy maintenance rigidity and the main speed control flexibility. These ac motor are also used in agriculture sector for water pumping. So the following system is proposed to protect ac motors from electrical faults like under-over voltage single phasing and overheating etc. which helps to improve reliability of system in which motor is installed and the facility to control motor by using mobile makes it more user friendly. [1]

OBJECTIVE

There are two main objective of this system:

- 1] To protect ac motor from faults like under-over voltage, single phasing, over heating etc.
- 2] To switch on-off motor through GSM [3]

METHODOLOGY

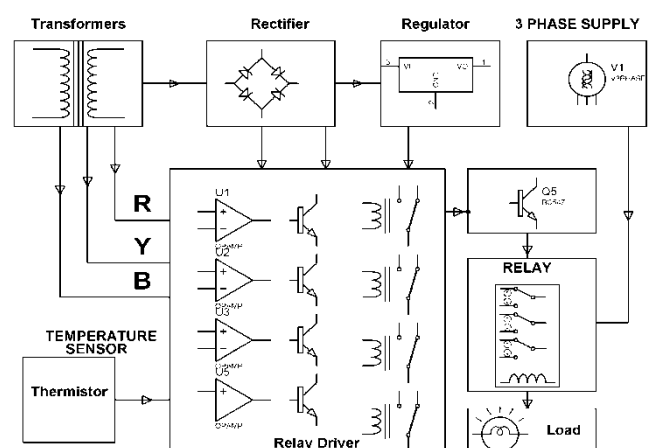

BLOCK DIAGRAM

There are two main section of this system one is to protect motor from faults and other is to make on-off using GSM. For this purpose system will use 8051 microcontroller, 3 single phase transformer, 4 relay, relay driver, LM-339,

National Conference on Current Trends in Engineering, Science and Technology (NACCTEST- 2018)
Organized by GF's Godavari College of Engineering, Jalgaon
International Journal of Innovations in Engineering and Science, Special Conference Issue, 2018
www.ijies.ne

voltage regulator 7805, GSM module etc. 3 relay assigned for each supply phase and remaining one relay out of four assigned for temperature condition. In normal operating condition all relay is at NC position but when any fault Occurred in the system corresponding relay become NO and breaks the supply to load to stop motor immediately. For making motor ON through mobile user have to send a message as 'PUMP ON' to feed number in GSM module and to make it OFF user have to just simply send message as 'PUMP OFF' to GSM module.

PROTECTION OF OVER VOLTAGE

In over voltage protection system of three phase induction motor protects the motor from over voltage, the voltage which is more than rated voltage. In circuit diagram of overvoltage protection, it consist the comparator which compare two voltages one is supply and other is drop across the variable resistance. When the voltage drop across the variable resistance is higher than certain limit then comparator generates signal. This signal is fed to microcontroller and microcontroller takes the suitable action.[2]

PROTECTION OF UNDER VOLTAGE

In under voltage protection of three phase induction motor feeds the protection from the under voltage. When supply system has low voltage than the certain rated of induction motor then under voltage protection section of protection supply is provided to motor. Single phasing works. It has similar concept as over voltage it also has comparator which compare two voltage one from supply and other from the voltage drop .Across the variable resistance. When voltage drop across the variable resistance is less than certain limit, this signal sends to microcontroller and microcontroller stop the working of motor in the case of running and fails to work in case of starting.[2]

PROTECTION OF SINGLE PHASING

If any of the phases, out of the 3 phases is missing or if the temperature of the motor during operation exceeds the threshold value, motor stops immediately. The system uses a 3-Phase power supply where three single phase transformers are connected to it. If any of the

phases is not available the corresponding transformer stops supplying power to the circuit. This leads to one of the four relays getting switched OFF. The main relay which is powered through a set of four relays gets disconnected because of one relay not being powered. Thus the main relay that delivers 3 phase supply to the motor gets disconnected.

DESIGN

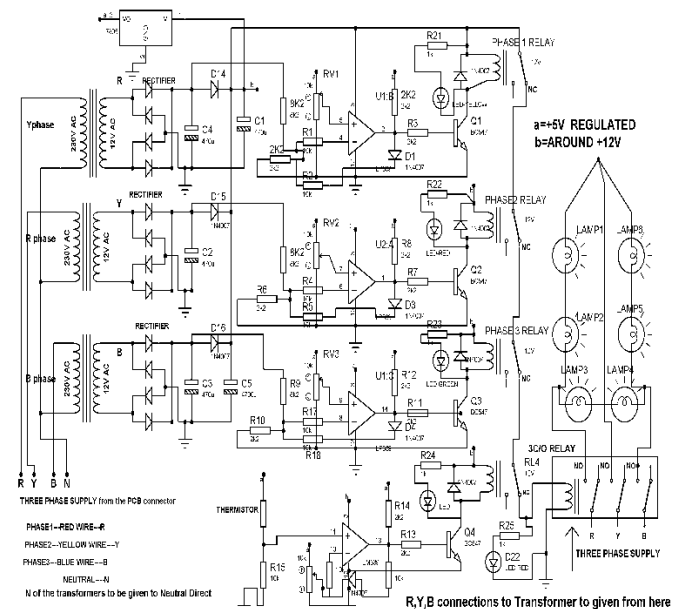

Three numbers step-down transformers from 230v to 12v are used with their primary connected in star and secondary are individually fed to three bridge rectifiers with filter capacitors C2, C3 & C4 from where the DC voltage is fed to a quad Op-amp used as comparator LP339/LM339 to the respective inverting inputs after passing through potential divider. The non-inverting inputs of first three comparators are given pre-settable DC voltage by RV1, RV2 & RV3. Another Op-amp is used with its inverting input by a pre-settable voltage while its non-inverting input is given to a series connected thermistor resistor arrangement across the 5v supply. The output of all the 4 comparators are given to drive Q1, Q2, Q3, and Q4 that operate respective relays. All the common NC contacts of the relays are connected in series and are fed from a DC supply to another 3 CO relay coil with the other point of that connected to GND. Three diodes D14, D15 & D16 are used respectively from each secondary generated DC and finally filtered by C1. Reason

National Conference on Current Trends in Engineering, Science and Technology (NACCTEST- 2018)
Organized by GF's Godavari College of Engineering, Jalgaon
International Journal of Innovations in Engineering and Science, Special Conference Issue, 2018
www.ijies.ne

behind this is to ensure un-interrupted DC supply for the circuit operation in the event of failure of any one face. A regulator IC 7805 is used for providing steady voltage reference to RV1, RV2, and RV3 & RV4. In normal operations pre-sets RV1, RV2, RV3 & RV4 are so set that the output of the comparators is held low resulting in 4 relays phase1 relay, phase2 relay, phase3 relay, temperature relay number4 all are in deactivated condition so the 12v dc flows through NC contacts of the those relays to the coil of the 3CO relay forcing it be in active operation so that 3 phase supply is available to the load through the NO contact of the 3CO relay. In the event of failure of any phase the corresponding comparator output goes high that switches ON the respective relay, the contact of which opens to discontinue the 12V DC supply to the 3CO relay Coil. As the 3 CO relay now is deactivated the 3 phase motor connected in series with the NO contacts open to stop the motor. Similarly while the temperature goes high on the body of the motor, the mounted thermistor resistance falls to develop logic high for Q4 to operate relay4 & disconnect the DC voltage to the 3CO relay coil. Thus in the process the motor is protected against any phase failure or high body temperature.

CONCLUSION

By taking into consideration the importance of three phase induction motor in industry, This paper come up with very cost effective and reliable solution for its protection from various electrical faults which helps to improve its lifetime-efficiency and also provide uninterrupted running of motor. This system also

provides facility to control motor through remote area by using cell phones GSM technology.

ACKNOWLEDGMENT

The authors acknowledge the contributions of the students, faculty of gf's Godavari College of Engineering for helping in the design and mounting of system circuit and for tool support. The authors also thank the anonymous reviewers for their thoughtful comments that helped to improve this paper. The authors would like to thank the anonymous reviewers for their constructive critique from which this paper has greatly benefited.

REFERENCES

- [1] IramZakir Shaikh, 2015 "Three Phase Motor Control using GSM" International Journal of Modern Trends in Engineering and research e-ISSN No.:2349-9745
- [2] Vaishali M. Kamble, 2017 "protection and monitoring of three phase induction motor from over Voltage, under voltage, single phasing, phase reversal, and overheating review" volume: 04
- [3] Kamrul Hassan, 2013 "GSM Based Automatic Motor Control and Protection System" International Journal of Advancements in Research& Technology, Volume 2, Issue2
- [4] DipaliSalave, 2018 "Microcontroller Based detection and protection of induction motor" International Research Journal of Engineering and Technology (IRJET) volume: 05

Analysis Of Solar Small Size 100 Va Inverter For 55Watt Led TV

Mahesh H. Patil¹, Tushar S. Patil², Shubham S. Patil³, Madhuri R. Patil⁴,

¹ Assistant Professor of Electrical Department

^{2,3,4} Student, Electrical Department

Gf'S Godavari College of Engineering, Jalgaon, India, 425003

1)patil335@gmail.com 2)mwgamers94@gmail.com

Abstract –In that project we are focusing on the analysis of solar small size 100VA inverter for 55 watts LED TV. We know that the normal 500 VA solar inverters are much heavy near about 8kg to 10 kg. Now this good for other loads. But in case our load is low like LCD or LED TV, laptop. In this case that heavy and bulky inverter is not so good. Then we replace that to 100VA solar inverter and this inverter is light in weight, compact in size and also low cost a means low in cost. And because of using solar inverter then we also save the electrical energy. On that project we will analyze the behavior of inverter by connecting variable loads and variable range of input panels (PV panels) to the inverter.

Keywords- Solar Inverter, PV panel, Batteries, LCD or LED TV.

INTRODUCTION

In today's climate of growing energy needs and increasing environmental concern, alternatives to the use of non-renewable and polluting fossil fuels have to be investigated. One such alternative is solar energy.

I. Problem statement

The world demand for electric energy is constantly increasing, and conventional energy resources are diminishing and are even threatened to be depleted. More over their prices are rising. For these reasons, the need for alternative energy sources has become indispensable, and solar energy in particular has proved to be a very promising alternative because of its availability and pollution free nature.

Due to the Increasing efficiencies and decreasing cost of photovoltaic cell and the improvement of the switching technology used for power conversion, our goal is to design an inverter powered by PV panels and that could supply stand-alone AC loads.

II. Objective And Scope

The main objective of our project is to design and develop and construct a PV based system that produces electric energy and operates in dual mode, supplying stand-alone AC loads, while minimizing its cost and size. The systems main property is to production of quality electricity from a renewable source to reduce dependence on fossil fuels and the associated emissions of pollutants. Our goal is to design and develop an inverter that will handle the task described.

METHODOLOGY

Solar energy conversion is done by using solar inverter and battery. Because of we used the pure sine wave solar inverter the charge controller is inbuilt on this. Therefore we installed the system as per fig.

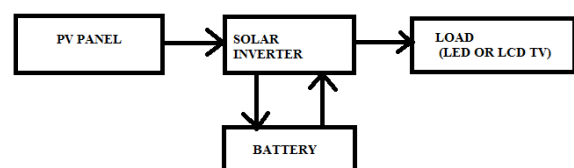

Fig. solar energy conversion process

In this system we used the 100 watt pure sine wave inverter, PV panels as supply and LCD TV as load..

National Conference on Current Trends in Engineering, Science and Technology (NACCTEST- 2018)

Organized by GF's Godavari College of Engineering, Jalgaon

*International Journal of Innovations in Engineering and Science, Special Conference Issue, 2018**www.ijies.net***I. PV panels**

The working principle of solar cells is based on the photovoltaic effect, i.e. the generation of a potential difference at the junction of two different materials in response to electromagnetic radiation.

The photovoltaic effect is closely related to the photoelectric effect, where electrons are emitted from a material that has absorbed light with a frequency above a material-dependent threshold frequency.

In short that's a bunch of solar cells. And for better efficiency we set that at a particular angle and direction. [1], [2].

For this system we connect the two PV panels in series.

II. Solar Inverter

In this type of inverter charge controller is inbuilt in this inverter means this inverter work in two phase first convert variable DC to fixed DC and second is converting fixed DC to AC pure sine wave output.

III. Battery

We are used the 12 volt, 10Ah battery for backup power to system.

IV. Load (LEDTV)

We connect the LED TV as load and analyze the system. And the load is 55watt.

DESIGN**Solar PV System Design**

A solar PV system design can be done in four steps:

- 1) Load estimation
- 2) Estimation of number of PV panels
- 3) Estimation of battery bank
- 4) Cost estimation of the system.

Base condition: 1 LED TV for 8hrs a day.

The total energy requirement of the system (total load) i.e.

Total connected load to PV panel system

$$= \text{No. of units} \times \text{rating of equipment} = 1 * 55 = 55 \text{ watts}$$

Total watt-hours rating of the system

$$= \text{Total connected load (watts)} \times \text{Operating hours} = 55 \times 8 = 440 \text{ watt-hours}$$

Actual power output of a PV panel = Peak power rating \times operating factor

$$= 50 \times 0.75 = 37.5 \text{ watt}$$

The power used at the end use is less (due to lower combined efficiency of the system

$$= \text{Actual power output of a panel} \times \text{combined efficiency}$$

$$= 37.5 \times 0.81 = 30.375 \text{ watts (VA)}$$

$$= 30.375 \text{ watts}$$

Energy produced by one 50 Wp panel in a day

$$= \text{Actual power output} \times 8 \text{ hours/day (peak equivalent)}$$

$$= 30.375 \times 8 = 243 \text{ watts-hour}$$

Number of solar panels required to satisfy given estimated daily load:

$$= (\text{Total watt-hour rating (daily load)} / (\text{Daily energy produced by a panel})) = 440 / 243 = 1.81$$

$$= 2 \text{ (round figure)}$$

Inverter size is to be calculated as:

Total connected load to PV panel system = 55 watts

Inverter size = Total load + losses

$$= 55 + (55 * 0.1)$$

$$= 60.5 \text{ watt}$$

Inverter are available with rating of 100, 200, 500 VA, etc.

Therefore, the choice of the inverter should be 100 VA.

Now the required backup time in Hours = 1 Hours

Suppose we are going to install 10Ah, 12volt battery

$$P = V * I$$

$$= 12 * 10$$

$$= 120$$

Backup time of Battery =

Losses in battery = 10%

$$= 120 * 10 / 100$$

$$= 12$$

Assumptions Taken For Design

Inverter converts DC into AC power with efficiency of about 90%.

Battery voltage used for operation = 12 volts

The combined efficiency of inverter and battery will be calculated as:

$$\text{Combined efficiency} = \text{inverter efficiency} \times \text{battery efficiency}$$

$$= 0.9 \times 0.9$$

$$= 0.81 = 81\%$$

Sunlight available in a day = 8 hours/day (equivalent of peak radiation).

Operation of LED TV = 8 hours/day of PV panels.

PV panel power rating = 50 Wp (Wp, meaning, watt (peak), gives only peak power output of a PV panel) [3].

National Conference on Current Trends in Engineering, Science and Technology (NACCTEST- 2018)

Organized by GF's Godavari College of Engineering, Jalgaon

*International Journal of Innovations in Engineering and Science, Special Conference Issue, 2018**www.ijies.net***Standard Inverter Losses (10 %):**

Sr. No.	Inverter size (VA)	Losses (VA)
1.	2000	200
2.	1000	100
3.	500	50
4.	200	20
5.	100	10

READINGS ON VARIOUS WATTS OF INPUT PANELS**50+20=70 watt parallel connection on load (TV)**On This Condition I₂ Is Negative, Up To Trip Condition

Sr. no.	V ₁	I ₁	V ₂	I ₂
1.	12.6	2.86	12.9	1.03
2.	12.8	2.91	12.9	0.9
3.	12.9	2.97	12.9	0.8
4.	13.1	3.07	13	0.66
5.	13.2	3.12	13	0.6
6.	13.3	3.16	13	0.5
7.	13.4	3.24	13	0.4
8.	13.5	3.32	13	0.3
9.	13.6	3.35	13.1	0.27
10.	13.7	3.4	13.1	0.25
11.	13.5	3.28	13	0.34
12.	13.2	3.15	12.9	0.54
13.	13.3	3.22	13	0.45
14.	13.3	3.25	13	0.41
15.	13.3	3.2	13	0.45
16.	13.2	3.15	12.9	0.51
17.	13.2	3.1	12.9	0.55
18.	13.3	3.2	12.9	0.45
19.	13.2	3.15	12.9	0.5
20.	13.1	3.11	12.9	0.56
21.	13.1	3.08	12.9	0.6
22.	13	3.05	12.9	0.64
23.	13	3.02	12.9	0.7
24.	12.9	3.00	12.9	0.71
25.	12.8	2.97	12.9	0.72(Trip)
26.	12.78	1.16	13.2	0.34
27.	12.9	2.91	13	0.86

Discharging to charging no load

SR.NO.	V ₁	I ₁	V ₂	I ₂
1.	17.8	1.07	13.3	0.26
2.	18.7	0.71	13.4	0.11
3.	18.5	0.69	13.4	0.21

8.083 Is A Charging Power From Mains

13.7 charging voltage and

0.59 is a charging current given to the battery

Switch off the mains supply.

TV Is On ConditionIn This Condition I₂ Is Negative.

SR.NO.	V ₁	I ₁	V ₂	I ₂
1.	12.3	2.07	13.3	1.99
2.	11.7	2.07	13.1	2.01
3.	11.6	2.05	13	2.05
4.	19.8	0	13.3	0
5.	16.1	1.95	13.4	0.5

CONCLUSION

We used small size inverter 100 watt rating instead of high capacity inverter because it reduce the losses so in order to reduce this losses we used 100VA solar inverter due to this inverter efficiency is going to better than high capacity inverter also the cost of the inverter is reduce. The describe design of the system will produced the desired output of the project the inverter will supply and AC source from DC source. The project describe is valuable for promising potential is hold with in ranging from the long run economic benefits to the important environmental advantages.

ACKNOWLEDGMENT

The authors acknowledge the contributions of the students, faculty of GF's Godavari College of Engineering for helping in design and tool support. And also special thanks to Ass.Prof. Mahesh H. Patil. The authors also thank the anonymous reviewers for their constructive critique from which this paper has greatly benefited.

National Conference on Current Trends in Engineering, Science and Technology (NACCTEST- 2018)

Organized by GF's Godavari College of Engineering, Jalgaon

International Journal of Innovations in Engineering and Science, Special Conference Issue, 2018

www.ijies.net

REFERENCES

1. "Basic PV principle and methods" SERI/SP 290-1448 solar information module 6213 published February 1982 page. No. 9-15.
2. Solar energy
https://courses.edx.org/c4x/DelftX/ET.3034TU/asset/solar_energy_v1.1.pdf
3. .SOLAR PV SYSTEM DESIGN,
<http://nit.ac.in/teqip/pdf/REPORT.pdf>.

National Conference on Current Trends in Engineering, Science and Technology (NACCTEST- 2018)
 Organized by GF's Godavari College of Engineering, Jalgaon
International Journal of Innovations in Engineering and Science, Special Conference Issue, 2018
 www.ijies.net

PLC Based Object Sorting According To Height

Vijay Choudhary¹, Sagar Kale², Shubham More³, Mahesh Patil⁴, Bharat Patil⁵

¹Assistant Professor, Electrical Engineering Department
^{2,3,4,5}Student, Electrical Engineering Department
 Gf's Godavari Collage of Engineering, Jalgaon, India, 425001
 1) sagarkale49@gmail.com 2) moreshubham49@gmail.com

Abstract – In today's world of technology and due to speed running industries, the production rate has increased tremendously. Here sorting plays an important role. Industrial automation mainly focuses on developing automations having low cost, low maintenance, long durability and to make systems user friendly as possible. This project consists of two parts, first consisting of software which contains ladder logic programming which is used to program PLC that controls the whole process of the project step by step according to input data sequence. Second is the hardware part which consists of conveyors used to transport the objects, sensors used to sense the height.

The development of a LCA (Low Cost Automation) system to sort objects according to their height has been discuss. This LCA system is controlled by Programmable Logic Controller (PLC). The objects are been sorted according to their respective height. The main conveyor is supported of two branches to load the distinguished object on to the respective one as separated by the electronic system and detected by the laser sensors.

Keywords-Programmable Logic Controller, Manufacturing, Sorting, Low Cost Automation.

INTRODUCTION

In this project, we have developed a Low Cost Automation System for sorting the light weight objects on the basis of height variation. The project mainly focuses on sorting 3 different height objects using photo-electric sensors and DC geared motors interfaced with Programmable Logic Controller (PLC). PLC is programmed with three different logics, each for sorting. Sorting is very important in any type of industry such as manufacturing industry to improve the efficiency of manufacturing processes g different height product. The

purpose of this project is to save the time for inspection and to reduce the efforts of the workers in material handling. A sorting machine is more practical and economical method of automation, which transfers material from one point to another.

Conveyor: - A conveyor belt consists of two or more pulleys, with a continuous loop of material which rotates over them. There are two main industrial classes of belt conveyors; The system needs to satisfy industry requisition. This is an industrial automation based application. The problem statement for the project is to create the electronic material handling system which can be used to reduce the efforts of workers as well as to reduce the time spent in inspection of the components, during their manufacturing. It also reduces the efforts in transferring the components manufactured to anther workstation. The most apparent reasons that are associated in installing of automatic system in industry are i. Saving Man Power ii. Improved Quality and Efficiency

LITERATURE SURVEY

Industrial automation and robotics play important role in growth of industry. The main criteria in industry are quality and flexibility of the product. In 80's robot were used to perform tasks like machine tending, material transfer, painting, welding which does not require high accuracy. All height sorters tested used Pulsed Light Emitting Diode (LED) technology to determine the height of material falling from the edge of a belt.

i) Existing System:

In currently existing systems, use of different technology is made according to budget and scope of industry. It

National Conference on Current Trends in Engineering, Science and Technology (NACCTEST- 2018)
Organized by GF's Godavari College of Engineering, Jalgaon
International Journal of Innovations in Engineering and Science, Special Conference Issue, 2018
www.ijies.net

includes robotics systems, microcontroller based system, sensor based system and pneumatic based system, etc.

ii) Robotics Systems:

The robotic arm is controlled using servo motors whose degree of rotation is controlled by the on timer of the pulse rail appearing at its control inputs. According to the structure of robotic arm various degree of rotation for the servomotor are assigned to carry out the operations. The arm of robot is realized using aluminum brackets. Four types of brackets are arranged for this purpose. Two types of the brackets are for holding the servo motors and two types for the extensions and interconnections of the robotic arm. The motion of the servo motor is controlled in a manner so that each box is dropped into a respective boxes place in a predetermined position.

METHODOLOGY

i) Block Diagram Description:

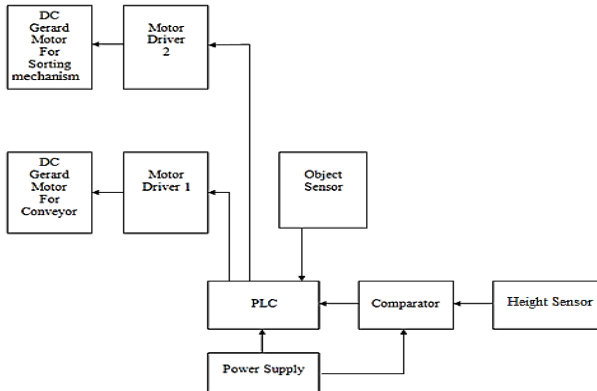

Fig.1:-Block Diagram of PLC based conveyor automation for Height sensing

Above figure shows block diagram of PLC based conveyor automation for height sensing object. This system is essential in industry where there is manufacturing of product and packaging industry also. This system is used for defect sorting and height based sorting for product. Proximity sensor sense the product which is to be sorted then the conveyor stops and sorting starts and object is picked by arm and placed it right or left side depending on the height.

This project is controlled by PLC. PLC is a small digital computer. CD20 CROUZET PLC is used in this

project. In this project three DC motors are used. First DC motor is used for rotating conveyor belt, second DC motor is used for gripping the object and third DC motor is used for sorting the object. Here first DC motor is used for interfacing between the PLC and DC geared motor sorting mechanism. Second DC motor is used for interfacing between the PLC and DC motor for conveyor belt [6].

ii) Programmable Logic Controller:

A PLC or a programmable controller is a small computer used for automation of real-world processes, such as control of machinery on factory assembly lines. A PLC can be programmed to sense, activate, and control industrial equipment. Therefore, a PLC incorporates a number of I/O points, which allow electrical signals to be interfaced. Input and output components of the processes are connected to the PLC; and the control program is loaded on the PLC memory.

In this, the PLC measures the current, the voltage, the temperature, and the speed of an induction motor through analog inputs. In addition, it continuously monitors the inputs and activates the outputs according to the program. Siemens PLC S7-200 module with 14 digital input/10 digital output addresses with CPU 224 sample (14 *DI 24 V dc/10 *DO 24 V dc) is preferred due to its easy usefulness in experimental application. The PLC programming memory used is composed of 4096 words. STEP 7—Micro/Win 32 programmer was used as the software. Statement list editor (STL) and ladder diagram (LAD) are used as programming languages. Software of the PLC was prepared on the computer and loaded on the PLC by RS 232-RS 485 PC/plan-position indicator (PPI) cable. While the program prepared is being loaded on the PLC from the computer, the most important point is the baud rate between the Fig .Analog and digital PLC module [1].

iii) Specification of PLC Crouzet CD-20:

1. Display -7 segment LED
2. Digits- 3 digit
3. Input Specifications
4. No of digital inputs- 8
5. Input types TTL
6. Response time- 1to 255ms
7. Isolation -2kv

DESIGN

i) Circuit Diagram:

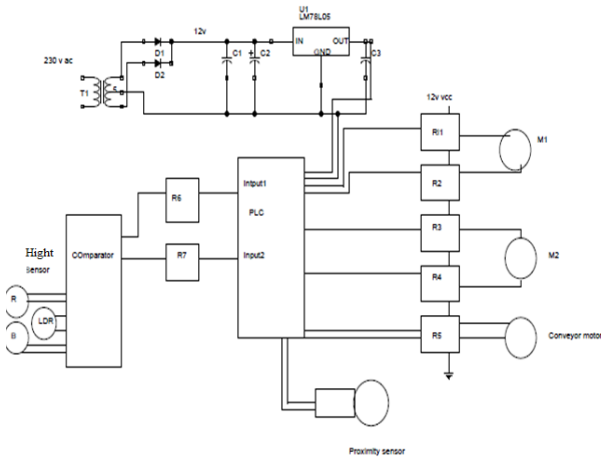

Fig.2:- Complete Circuit Diagram

ii) Working:

When we switch on the power supply first all sensor and output devices are configured then conveyor motor start rotating and objects starts moving forward when object reaches up to proximity sensor which sense the object and immediately conveyor motor stops then height sensor sense the height of the objects and gripper motor M1 start rotating for specified time and then M1 motor stops and M2 motor start rotating according to height they kept the object right or left [5].

iii) Robotic Gripper:

Robot mechanical grippers and its actuating mechanisms can be classified into several methods. The first method is based on the type of finger movement. During this arrangement, the opening and closing of the fingers can be actuated by either pivoting, or linear or translational movement.



Fig 3:- Robotic Gripper

The second method of classifying the mechanical grippers is based on the type of kinematic device used for the actuation of finger motions. It can be accomplished by anyone of these types: linkage, screw, gear and rack, rope and pulley, or cam actuation [3].

iv) Flowchart of System:

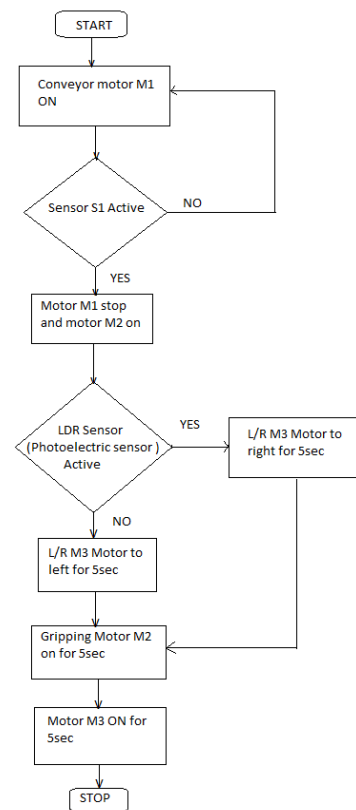

Fig.4:- Flowchart of System.

v) Developed Software:

In order to achieve the protection of the IM easily, a PLC program was developed in Micro win using LAD programming method. The PLC system provides a design environment in the bay in direct al fault detection and protection of induction motors using sensors Flowchart of the software developed form of software tools running on a host computer terminal that allows LADs to be developed, verified, tested, and diagnosed. First, the high-level program is written in LADs. The LAD is then converted to binary instruction codes, so

National Conference on Current Trends in Engineering, Science and Technology (NACCTEST- 2018)
Organized by GF's Godavari College of Engineering, Jalgaon
International Journal of Innovations in Engineering and Science, Special Conference Issue, 2018
www.ijies.net

that they can be stored in RAM or erasable programmable read-only memory (EPROM). Each successive instruction is decoded and executed by the CPU. The function of the CPU is to control the operation of memory and I/O components and to process data according to the program. Each input and output connection point on a PLC has an address used to identify the I/O bit. Flowchart of the program is given in Fig. The software processes and displays the data achieved from the PLC output easily [2].

vi) Applications:

Manual sorting of any object consumes a lot of time and labour. Hence, PLC object sorting system finds wide application in the following industries.

1. Brick Manufacturing Process:

In Brick manufacturing Process the quality of bricks considering their height as a parameter can be checked. If the height is more or less from the original size then the defective bricks can be sorted out.

2. Luggage sorting at Airports:

The parcels at airport which has to loaded in cargo planes can be sorted accordingly to reduce the load of the plane.

3. Quality Checking of Solid Objects:

If the height of the solid material is taken as a criteria in quality check of that object then this system can be used effectively.

4. In Food Processing Industries:

The food packing of the food stuffs of different sizes can be sorted in such type of industries where various quantities of packed food are running on a single line.

according to the availability of the materials and components. This setup can be further improved to a sorting system that sorts the items based on the other physical consideration. This can be achieved using the various sensors. In industry it can be used for sorting of various objects, tools, with high degree of accuracy and quality with an automation.

By using Robotic arm to sorting the object in the system it has main function we used in this project Most importantly it is confirmed that with some modification in programming and hardware. Core objective of "plc base conveyor" successfully achieved, which was a full success. PLC controller is the main brain and has burned program in it. The project has a grant success and real time output.

REFERENCES

- [1]William Bolton, "Programmable Logic Controller", 2nd Edition, Tata McGraw Hill, P.P. 170-177.
- [2]Neal Baboock, "PLC programming and Application", 2nd Edition, Penram International, P.P. 60-78.
- [3] Ramakant Gayakwad, "IC555 & Linear Integrated Circuits", Pearson Education, 4th Edition, P.PF. 207-215.
- [4] Web Site – <http://www.datasheets.com>
- [5] Manjunatha "Postal Automation System for Mail Sorting" International Journal of Emerging Technology and Advanced Engineering (ISSN 2250-2459) Volume 5, Issue 3, March 2015)
- [6] Shaukat.N, PLC based Automatic Object Sorting Machine, Multi Topic Conference 2002, IEEE publications.

CONCLUSION

In this work it has been tried to create a setup that will decrease human effort and succeeded to an extent by using the low cost automation system (LAC) to avoid risk, improve accuracy, increase speed of production and reduce the cycle time. Limitations will be there due to the practical difficulties in programming of the project

National Conference on Current Trends in Engineering, Science and Technology (NACCTEST- 2018)
 Organized by GF's Godavari College of Engineering, Jalgaon
International Journal of Innovations in Engineering and Science, Special Conference Issue, 2018
www.ijies.net

Brushless Dc Motor Speed Control Using Microcontroller

Vijay Chaudhary¹, Mohd Adil Pinjari², Shaikh Nadeem³, Rahul Badgajar⁴, Rahul Lokhande⁵

¹Assistant Professor, Electrical Engineering Department
^{2,3,4,5}Student, Electrical Engineering Department
 Gf's Godavari Collage of Engineering, Jalgaon, India, 425001
 1) nsaikh751@gmail.com 2) badgujarr19@gmail.com

Abstract – The hardware project is designed to control the speed of a BLDC motor using closed loop control technique. BLDC motor has various application used in industries like in drilling, lathes, spinning, electric bikes etc. The speed control of the DC motors is very essential. This proposed system provides a very precise and effective speed control system. The user can enter the desired speed and the motor will run at that exact speed.

Keywords- Hall position sensors, Brushless DC motor, Microcontroller.

INTRODUCTION

Permanent -magnet excited brushless DC motors are becoming increasingly attractive in a large number of applications due to performance advantages such as reduced size and cost, reduced torque ripples, increased torque-current ratio, low noises, high efficiency, reduced maintenance and good control characteristics over a wide range in torque-speed plan. In general, Brushless DC motors such as fans are smaller in size and weight than AC fans using shaded pole or Universal motors. Since these motors have the ability to work with the available low voltage sources such as 24-V or 12-V DC supply, it makes the brushless DC motor fans convenient for use in electronic equipment, computers, mobile equipment, vehicles, and spindle drives for disk memory, because of its high reliability, efficiency, and ability to reverse rapidly. Brushless dc motors in the fractional horsepower range have been used in various types of actuators in advanced aircraft and satellite systems torque null regions are reduced significantly [8, 11]. In this paper, a brushless DC motor with distributed winding and a special form of PM-rotor with special stator periphery are described. Which develop a speed control system for a BLDC motor by closed loop control technique

PRESENT PROBLEM

The producing of electricity is ultimately responsible for hot and humid conditions i.e. global warming. As in below shown chart it is clear that major quantity of electricity is produced by coal (fossil fuel). Fossil fuels also contain radioactive materials, mainly uranium and thorium, which are released into the atmosphere, which contribute to smog and acid rain, emit carbon dioxide, which may contribute to climate change. Longer power cut durations in villages and high cost of cooling products.

PROPOSED SOLUTION

Need of such a source which is abundantly available in nature, which does not impose any bad effects on earth. There is only one thing which can come up with these all problems is solar energy.

OBJECTIVE THE PROJECT

Pulse-width modulation (PWM) is a commonly used technique for controlling power to an electrical device, made practical by modern electronic power switches. The average value of voltage (and current) fed to the load is controlled by turning the switch between supply and load on and off at a fast pace The desired speed can be obtained by changing the duty cycle. The PWM in microcontroller is used to control the duty cycle of DC motor.

Average Voltage = $D * V_{in}$

National Conference on Current Trends in Engineering, Science and Technology (NACCTEST- 2018)
Organized by GF's Godavari College of Engineering, Jalgaon
International Journal of Innovations in Engineering and Science, Special Conference Issue, 2018
www.ijies.net

METHODOLOGY

Though various control techniques are discussed in [8] basically two methods are available for controlling BLDC motor. They are sensor control and sensor less control. To control the machine using sensors, the present position of the rotor is required to determine the next commutation interval. Motor can also be controlled by controlling the DC bus rail voltage or by PWM method. Some designs utilize both to provide high torque at high load and high efficiency at low load. Such hybrid design also allows the control of harmonic current [9]. In case of common DC motors, the brushes automatically come into contact with the commutator of a different coil causing the motor to continue its rotation. But in case of BLDC motors the commutation is done by electronic switches which need the rotor position. The appropriate stator windings have to be energized when rotor poles align with the stator winding. The BLDC motor can also be driven with predefined commutation interval. But to achieve precise speed control and maximum generated torque, brushless commutation should be done with the knowledge of rotor position. In control methods using sensors, mechanical position sensors, such as a hall sensor, shaft encoder or resolver have been utilized in order to provide rotor position information.

Hall Position sensors or simply Hall sensors are widely used and are popular. Whenever the magnetic poles pass near the sensors, they either give a high or low signal, indicating North or South Pole is passing the pole. The accurate rotor position information is used to generate precise firing commands for power converter. This ensures drive stability and fast dynamic response. The speed feedback is derived from the position sensor output signals. Between the two commutations signals the angle variation is constant as the Hall Effect Sensors are fixed relative to the motor, thus reducing speed sensing to a simple division. Usually speed and position of a permanent magnet brushless direct current motor rotor is controlled in a conventional cascade structure. The inner current control loop runs at a larger width than the outer speed loop to achieve an effective cascade control [10]. Various senseless methods for BLDC motors are analyzed in [11]. Modeling of BLDC is given in [12]. [11] Proposes a speed control of brushless drive employing PWM technique. The above literature does not deal with reduction of speed oscillations and also the motor can't runs at exact speed in BLDC drive. This paper deals with control method to reduce speed oscillations and to runs the motor at exact entered speed. This is achieve by using the microcontroller programming .

WORKING MODEL OF PROJECT

Brushless DC motors were developed from conventional brushed DC motors with the availability of solid state power semiconductors. Brushless DC motors are similar to AC synchronous motors. The major difference is that synchronous motors develop

a sinusoidal back EMF, as compared to a rectangular, or trapezoidal, back EMF for brushless DC motors. Both have stator created rotating magnetic fields producing torque in a magnetic rotor.

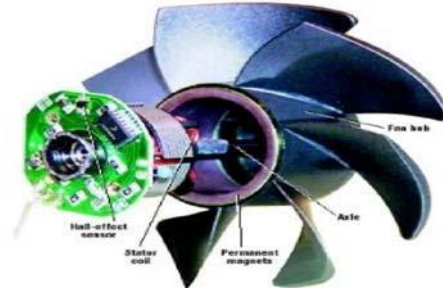

Fig.1 : Working of BLDC motor

DESIGN

BLDC MOTOR SPEED CONTROL-

Pulse-width modulation (PWM) is commonly used technique for controlling power to an electrical device, made practical by modern electronic power switches. The average value of voltage (and current) fed to the load is controlled by turning the switch between supply and load on and off at a fast pace. The longer the switch is on compared to the off periods, the higher the power supplied to the load is. The PWM switching frequency has to be much faster than what would affect the load, which is to say the device that uses the power. Typically switching's have to be done several times a minute in an electric to, 120 Hz in a lamp dimmer, from few kilohertz (kHz) to tens of kHz for a motor drive and well into the tens or hundreds of kHz in audio amplifiers and computer power supplies. The term duty cycle describes the proportion of on time to the regular interval or period of time; a low duty cycle corresponds to low power, because the power is off for most of the time. Duty cycle is expressed in percent, 100% being fully on. The main advantage of PWM is that power loss in the switching devices is very low. When a switch is off there is practically no current, and when it is on, there is almost no voltage drop across the switch. Power loss, being the product of voltage and current, is thus in both cases close to zero. PWM works also well with digital controls, which, because of their on/off nature, can easily set the need duty cycle. PWM has also been used in certain communication systems where its duty cycle has been used to convey information over a

communications channel.



Fig.6 : Pwm Pulses

National Conference on Current Trends in Engineering, Science and Technology (NACCTEST- 2018)
Organized by GF's Godavari College of Engineering, Jalgaon
International Journal of Innovations in Engineering and Science, Special Conference Issue, 2018
www.ijies.net

ACKNOWLEDGMENT

The authors acknowledge the contributions of the students, faculty of gf's godavari College of Engineering for helping in the design and fabrication of the dispenser and for tool support. The authors also thank the anonymous reviewers for their thoughtful comments that helped to improve this paper. The authors would like to thank the anonymous reviewers for their constructive critique from which this paper has greatly benefited.

CONCLUSION

The hardware for closed loop control of BLDC motor using microcontroller is designed. By using the PWM technique speed of the BLDC motor was controlled and it was made to run at exactly entered speed. In future this hardware will be implemented in dSPACE and the speed control will be observed.

REFERENCES

1. Kusko, A. & Peeran, S. M. (1987) Brushless DC motor using asymmetrical field magnetization. IEEE Transactions on Industrial Applications, **23** (2):319
2. Bolton, H. R. & Ashen R.A. (1984) Influence of motor design and feed current waveform on torque ripples in brushless dc motor. IEE Proceeding, **131** (3): 82 – 90
3. Duane, H. (2002) Brushless Permanent Magnet Motor Design. University of Maine, Orno, USA, 2nd ed.
4. Khader, S. H. (2001) Implementation of an accurate mathematical method formodeling electromagnetic processes of brushless DC Motor. MESM, Amman, Jordan, 31-38

Grid Synchronized Voltage Source Inverter Controlled By Using PI Controller

¹Sushil Kale, ²Pankaj Bari, ³Nikita Dhake, ⁴Dipak Patil, ⁵Atul Barhate, ⁶Amit Borole 1,2,3,4,Students, 5,6Assistant Professor, GF's Godavari college of engineering, North Maharashtra university, Jalgaon, Maharashtra, India, Pin- 425003
amit2010borole@gmail.com

Abstract - Over the years, power converters have found wide application in grid interfaced systems, including distributed power generation with renewable energy sources. In distributed energy systems like solar, hydro or any diesel generation where the output of the system is DC and is expected to be converted in AC, an inverter is used. There are various modes to have a controlled output of inverter. The paper consists of the study of three phase Voltage Source Inverter in grid connected mode. In PI control, the stationary reference frame is used to transfer the feedback quantities, where the decoupling of component requirement increases some complications. The main advantage with this controller is the reduction in steady state DC error. The PI controller is adopted in the most familiar dqo reference frame. The three phase system is simulated in the matlab-simulink environment with both the controllers and experimental results are given to prove the correctness and feasibility of the system.

Keywords—PI controller; d-q reference frame; reference tracking; Grid synchronization.

INTRODUCTION

Due to rapid depletion of fossil fuels and the rising demand of electricity power, the interconnection renewable energy sources (RES) including wind turbines, photovoltaic (PV), and other distributed generation etc., has raised concern in the last few years. Hence it became general trend to increase the electricity production using renewable power systems. According to the survey, in the last few years there is a great increase in the use of solar and other renewable energy systems. This increase is nearly from 5% to 20% of the total energy used. Also in the year 2008 - 2009 there is a drastic increase in use of solar energy compared to the last decade [1]. In order to control these renewable energy sources more effectively and fulfill power quality requirement, micro-grid concept is proposed more

recently. A micro-grid is a cluster of RES and loads, which can operate in both grid-connected mode and islanded mode. All the renewable energy sources are parallel connected to an ac common bus through inverters or ac-to-ac converters, the common bus is then connected to the utility/grid. The key functional element of an AC Micro-Grid system is a Voltage Source Inverter (VSI). The different Renewable Energy Sources (RES) within the Micro-Grid system can operate independently or interconnected to a common DC link which supplies constant input to the VSI. These systems are to be properly controlled in order to provide the reliable power system to the utility network [1]. Fig. 1 shows the block diagram of the photovoltaic grid interfaced system. It gives the general idea of distributed generation system consisting a boost converter and inverter. The renewable energy source used is photovoltaic system. As the output of Photovoltaic system is very low as compared to the grid utility voltage, the boost converter is required to boost the low level output of PV system. The output of the Boost converter is thus fed to the three phase voltage source inverter.

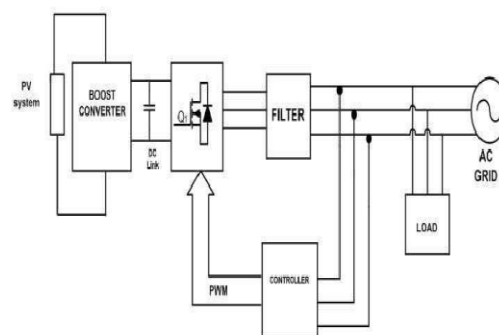

Figure 1. Block diagram of grid connected RE System

The output of the inverter is given to the grid utility through the filter. The control block, as shown in

Fig.1, is implemented with suitable control schemes. The sinusoidal pulse width modulation (SPWM) technique is adapted to send pulses to the inverter. DC link capacitor is used to regulate the output of boost converter so that inverter will get constant DC input [2].

The grid connected voltage source inverter may have following problems to face:-

- To maintain amplitude and frequency of the voltage in a micro-grid within a normal range when operating in autonomous mode;
- To share adequate active power and reactive power from energy sources to the loads when operating in autonomous mode;
- To perform optimal power exchange between micro-grid and the main power grid when operating in grid-connected mode;
- To ensure a smooth transfer between inverter and grid in autonomous mode and grid connected mode.

To satisfy all these requirements, we need a control system which will maintain these parameters at desired value.

It is very important to have a very reliable power supply and for that, the system needs, a good controller. This can be achieved by PI controller. The general conclusion is that, many of the controllers for this particular system are either overburdened because of the complex network or they are very difficult to implement. Hence the controller selection and its implementation becomes very important. The simple PI controller is used for controlling the inverter output. The main advantage of the PI controller is that there will be no remaining control error after a set-point change or a process disturbance. A disadvantage of PI controller is that there is a tendency for oscillations. PI control is used when no steady-state error is desired [3]. There is a use of synchronous frame in PI control, but to reduce the complications of decoupling in it, the stationary reference frame (α - β transformation) is used in PR (proportional resonant) controller.

- The new controller proposed, to overcome above disadvantages of PI controller, is Proportional Resonant (PR) Controller [2], [4]. The main advantage of PR controller is to reduce DC steady state error to zero by forcing the ideally infinite gain at the resonating

frequency. Also due to use of $\alpha - \beta$ transformation, the reference tracking system is improved [4].

II. SYSTEM DESCRIPTION

The micro-grid can be connected either in grid connected mode or an autonomous (islanded) mode. Normally the micro sources act as constant power sources, when they are operated in grid connected mode, which means that they are controlled to inject the demanded power in to the network. In autonomous mode the micro sources are controlled to supply all the power needed by the local loads while maintaining the voltage and frequency within the allowed limits. The system shown in Fig. 1, the RES is connected to the voltage source inverter and then it is fed to the grid. It consists of filter and inverter block whose specifications are given in the table no 1. The controller block given in Fig. 1 is implemented by PI controller. This controller is analyzed and implemented in following sections.

III. CONTROLLER

This paper reviews the control schemes for controlling the grid connected VSI. The current controller can have a significant effect on the quality of the current supplied to the grid by the inverter, and therefore it is important that the controller provides a high quality sinusoidal output with minimal distortion to avoid harmonics. The controllers which are used to control inverters are the PI controller with the grid voltage feed-forward path as described below.

PI Controller

For three phase systems, synchronous frame simple PI controller can be used as shown in fig.2. The main advantage of the PI controller is that there will be no remaining control error after a set-point change or a process disturbance. But the main problem with PI controller is that, there will be steady state error for three phase system, whereas, for single phase systems, PI controller is the most effective and easier to implement. Fig. 2 shows the PI controller implementation block diagram. PI controller requires abc to dqo reference transformation. As shown in Fig. 2, the voltage after the filter is sensed and phase lock loop is used to extract systems angular frequency from it.

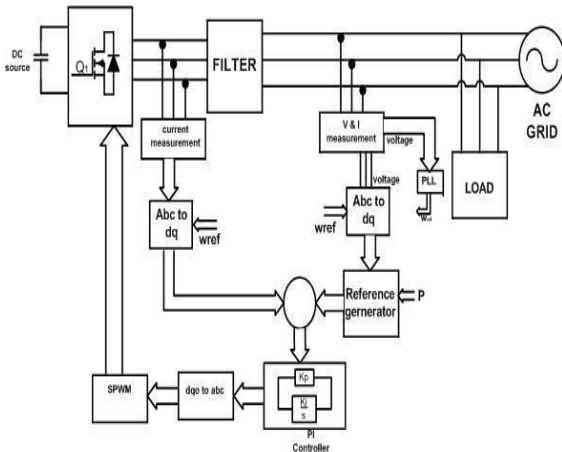

Figure 2. PI controller block diagram

The stationary dq0 transformation is done to track the error signal and then the signal is again transformed into abc quantities and is provided to PWM generator. The PI controller is used to minimize the error signal between actual current quantities sensed before the filter and the reference signal generated by voltage sensed after the filter. The reference generator block shown in Fig. 2 is implemented on the basis of (5) and (6). This block takes output voltage or grid voltage in dq0 reference frame (Vod and Voq), as input signals. Thus it generates reference current signals (idref and iqref) which are compared with actual current signals.

The active power (P) and reactive power (Q) supplied to grid can be given in synchronous reference frame as

$$P = 1.5(Vod id + Voq iq)(1)$$

$$Q = 1.5(Vod iq + Voq id)(2)$$

Where the Vod, Voq, id, iq are the voltages and currents after the filter in dq reference frame and P, Q are the active and reactive power respectively.

Assumed Voq = 0, and hence (1) and (2) can be written as

$$P = 1.5(Vod id)(3)$$

$$Q = 1.5(Vod iq)(4)$$

From above equations, id and iq can be extracted as-

$$id = 2P/3Vod (5)$$

$$iq = 2Q/3Vod(6)$$

These current signals are compared with actual and given to the PI controller. As PI controller requires feed forward path to improve reference tracking, grid voltage is fed to it. Then these signals are again transformed to abc frame and from SPWM, it is fed to the inverter switches.

Table No. 1

SYSTEM PARAMETER FOR GRID CONNECTED SYSTEM

Sr No.	Parameter	Value
1	Three phase peak voltage	330V
2	Grid voltage	230V
3	DC supply	650V
4	Supply frequency fs	50HZ
5	Switching frequency fsw	8kHz
6	Filter Inductance Lf	3 mH
7	Inductor internal resistance rf	0.05Ω
8	Filter capacitance	30μF
9	Capacitor resistance	0.5Ω
10	Load1 power	8000W
11	Load2 power	4000W

IV. SIMULATION RESULTS

The three phase voltage source inverter connected to the grid and is controlled by the Proportional Integral (PI) controller. The simulations are carried out for various load conditions and the system is thus examined. The DC supply is fed to the inverter as a distributed generation source. The LC filter is used to eliminate the

harmonics after the inverter. The quasi shaped inverter output is thus converted to sinusoidal wave. The filter output is fed to the load with grid connected in parallel. The parameter values used in the simulation are given in the table no 1.

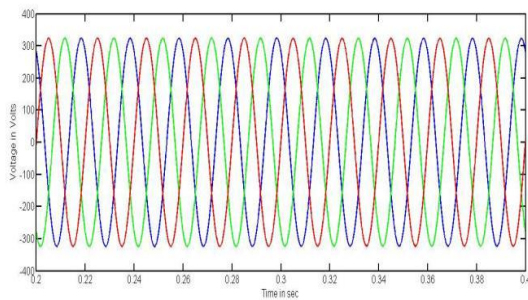

Figure 3. Three phase load voltage using PI controller

Fig. 3 shows the three phase load voltage fed from inverter. The grid is taking care of the voltage increased and controller maintains the voltage constant even though load is increased at instant 0.3sec. The Fig. 4 shows the three phase load current when inverter is controlled by PI controller.

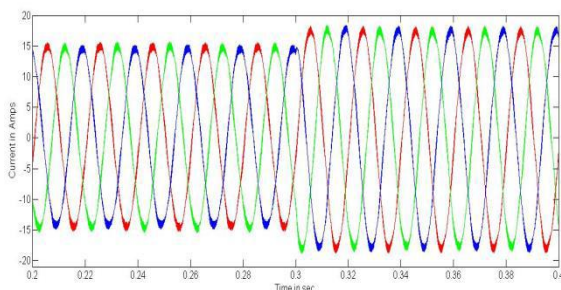
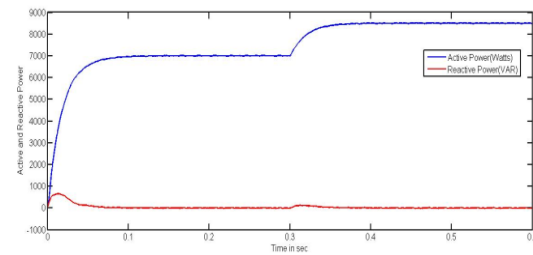

Figure 4. Three phase load current using PI controller

From Fig. 5 and Fig. 9 it can be seen that, during transient PI controller need some settling time, which can be improved by increasing order of controller. The settling time required by the PI controller is nearly 0.06 sec to reach to the steady state.



Figure

5. Active and Reactive power supplied by inverter to the load using PI controller.

V. CONCLUSION

In this paper, the main attempt made for showing the simulation results of PI controlled grid synchronized inverter. This paper proposes the detail analysis of the basic control strategy used for voltage source inverter and also gives the study of Photovoltaic grid interconnected system. The shortcomings of PI controller as more settling time, inadequate reference tracking system, and complicated implementation can be overcome in second order controllers. Hardware results will be tested and published with next paper.

References

- [1] H. Cha, T.-K. Vu, and J.-E. Kim, "Design and control of proportional-resonant controller based photovoltaic power conditioning system," pp. 2198–2205, Sept 2009.
- [2] R. Teodorescu, F. Blaabjerg, M. Liserre, and P. Loh, "Proportional-resonant controllers and filters for grid-connected voltage source converters," *Electric Power Applications, IEE Proceedings*, vol. 153, no. 5, pp. 750–762, September 2006.
- [3] A. Nachiappan, K. Sundararajan, and V. Malarselvam, "Current controlled voltage source inverter using hysteresis controller and pi controller," pp. 1–6, Jan 2012.
- [4] R. Teodorescu, F. Blaabjerg, M. Liserre, and A. Dell'Aquila, "A stable three-phase LCL filter based active rectifier without damping," vol. 3, pp. 1552–1557 vol.3, Oct 2003.
- [5] X. Yuan, W. Merk, H. Stemmler, and J. Allmeling, "Stationary-frame generalized integrators for current control of active power filters with zero steady-state

error for current harmonics of concern under unbalanced and distorted operating conditions,” *Industry Applications*, IEEE Transactions on, vol. 38, no. 2, pp. 523–532, Mar 2002.

[6] A. S. Borole, V. S. Rajguru, “Various Control Schemes for Voltage Source Inverter in PV grid interfaced system (PI controller)”, ICESA 2015

National Conference on Current Trends in Engineering, Science and Technology (NACCTEST- 2018)
 Organized by GF's Godavari College of Engineering, Jalgaon
International Journal of Innovations in Engineering and Science, Special Conference Issue, 2018
www.ijies.net

Solar Based Automatic Irrigation System

Bhagwat Shelke¹, Abhishek Joshi², Saurabh Patil³, Yogita Waykole⁴, Shruti Nimje⁵.

^{1,2,3,4,5} Students

GF's Godavari College of Engineering, Jalgaon, India, 425001
bhagwatshelke.84@gmail.com

Abstract – The field of agriculture has seen vast changes since last few years. This paper deals with the design of smart agricultural irrigation system based on solar power. This system consists of a solar powered single phase ac form along with an automatic control of water flow using a solenoid valve. It is the preferable solution for the energy crisis for the Indian farmers. This system limits the use of electricity provided by grid and conserves water by reducing water losses.

Keywords-Solar panel, Solenoid valve, Irrigation System.

I. INTRODUCTION

In India most of the power generation is carried out by conventional energy sources, coal and mineral oil-based power plants which contribute heavily to greenhouse gases emission. Setting up of new power plants is inevitably dependent on import of highly volatile fossil fuels. Thus, it is essential to tackle the energy crisis through judicious utilization of abundantly available renewable energy resources, such as biomass energy, solar energy, wind energy, geothermal energy and Ocean energy. The projection for irrigation water demand basically depends on irrigated area, cropping pattern, effective rainfall, and soil and water quality. Though our country claims to have developed in terms of science and technology, erratic power supply or complete breakdown for hours together has almost become routine today. If this be the case for urban dwellers, think about the farmers living in remote villages. They need power for irrigating their crops, or lighting their cattle sheds.

What can they do? The reasons for having large gap between requirement and consumed energy could be the wastage of electrical energy. The foremost reason can be that the power supplied for agricultural needs is during the night hours. Farmers Switch on the pump motor and leave it „on“ for the whole night. Farmers do not bother to switch off the pump motor when the land is filled with sufficient water level. This is the main source of wastage of electrical energy from the grid.

II. METHODOLOGY

In smart agriculture irrigation system pv cells also known as solar cells are used as the energy transducer from the sun which converts solar energy into this electric power stored in a battery through a charge controller. Battery supply is regulated by the fixed voltage regulators which has output of 5v and 12v dc. The 12v supply is given to the inverter to power the single phase ac pump another 5v supply is given to the microcontroller, Bluetooth and LCD which operate on the 5v dc supply.

Electrical power is stored in battery via charge controller. 4 solenoidal valve are fitted along with water level indicator in corresponding four lanes respectively. Power is switched manually on then the first solenoid valve gets open and the first lane starts to fill up. When the water level reaches to specified level specified by water level indicator. The signal generated goes to the microcontroller which in turn commands the first solenoid valve to switch off and the adjacent valve to open. The process which continue until all the lanes are filled with water. And in a response to this the water pump gets automatically turned off.

National Conference on Current Trends in Engineering, Science and Technology (NACCTEST- 2018)
 Organized by GF's Godavari College of Engineering, Jalgaon
International Journal of Innovations in Engineering and Science, Special Conference Issue, 2018
 www.ijies.net

The 5v dc supply is provided for the microcontroller and LCD display on which the valve is open or closed, condition of water level indicator is displayed

III.DESIGN

Component Description

.Solar panel: A solar panel is set of solar photovoltaic modules electrically connected and mounted on structure. A photovoltaic module is a packaged, connected assembly of solar cells. The solar panel can be used as a component of a larger photovoltaic system to generate and supply electricity in commercial and residential applications.

Battery: Are energy storage device that are particularly use for powering small portable devices .here we use battery for storing energy from solar panel. This energy use for water pumping

Solenoid vale.: A solenoid vale is an electromechanically operated valve. The valve is controlled by an electric current through a solenoid: in the case of a two-port valve the flow is switched on or off.

Water Level Indicator: Level sensors detect the level of liquids and other fluids and fluidized solids, including slurries, granular materials, and powders that exhibit an upper free surface. Substances that flow become essentially horizontal in their containers (or other physical boundaries) because of gravity whereas most bulk solids pile at an angle of repose to a peak. The substance to be measured can be inside a container or can be in its natural form (e.g., a river or a lake). The level measurement can be either continuous or point values

Microcontroller & ADC :The 8051 microcontroller is a low-power, high-performance 16-bit micro controller. The microcontroller build in rom, ram output input ports, serial ports, timer interrupts and clock circuit. A microcontroller is an entire computer manufacture on single chip. Microcontroller are use as motor controller in irrigation system. The input output, memory and on chip peripherals of microcontroller are selected depending on the application. Microcontroller are power full digital processor, the degree of control and programmability they provide significantly enhances the effectiveness application. An electronic integrated circuit which transforms a signal from analog (continuous) to

digital (discrete) form. Analog signals are directly measurable quantities. Digital signals only have two states. For digital computer, we refer to binary states, 0 and 1. The ADC 0809 data acquisition component is a analog to digital converter which convert the analog signal to digital signal.

16*2 LCD Display: It is a flat panel display, electronic visual display, or video display that uses the light modulating properties of liquid crystals. Liquid crystals do not emit light directly. LCDs are available to display arbitrary images (as in a general-purpose computer display) or fixed images which can be displayed or hidden, such as preset words, digits, and 7-segment displays as in a digital clock. They use the same basic technology, except that arbitrary images are made up of a large number of small pixels, while other displays have larger elements.

3.2 SPECIFICATION OF COMPONENTS

SR NO	COMPONENT DESCRIPTION
1	Solar Panel
2	Battery
3	AC Motor
4	Solenoid Valve
5	Level Indicator
6	Microcontroller

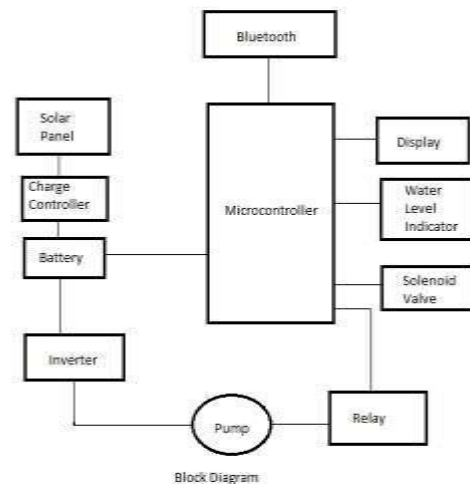

National Conference on Current Trends in Engineering, Science and Technology (NACCTEST- 2018)
 Organized by GF's Godavari College of Engineering, Jalgaon
International Journal of Innovations in Engineering and Science, Special Conference Issue, 2018
 www.ijies.net

IV.CONCLUSION

By implementing the preferred system there are various benefits for the government and farmers. For the government a solution for the energy crisis is proposed. By using the automatic irrigation system it optimizes the uses of water by reducing wastage and reduce the human intervention for farmers. The excess energy produce using solar panel can be given to grid with a small modification in the system circuit which can be a source of the revinew of the farmer, Thus encouraging farming in india and same time giving a solution for energy crisis. Proposed system is easy to implement and environment friendly solution for irrigation field. The system was found to be successful when implemented for bore holes as they pump over the whole day. Solar pump also offer clean solution with no dangour of bore hole contamination. The system require minimum maintainance and attension as they are self starting . To further engance the daily pumping rates tracking array can be implemented. This system demonstrates the feasibility and application of using solar pv to provide energy for the pumping requirements for sprinklers irrigation. Even though there is a high capital investment required for the system to be implemented, the overall benefits are high and in long run this system is economical.

V.REFERENCES

- [1] Ilon, B. E. (1975). Wheels for a Course Stable Selfpropelling Vehicle Movable in any Desired Direction on the Ground or Some Other Base. U.S. Patent. U.S.A.
- [2] Everett, H.R. (1995). Sensors for Mobile Robots: Theory and Application. A K Peters, Ltd, MA, USA.
- [3] Diegel, O.; Badve, A.; Bright, G.; Potgieter, J. & Tlatle, S. (2002)0. Improved Mecanum Wheel Design for Omni-directional Robots, Proc. 2002 Australian Conference on Robotics and Automation, Auckland, 27-29 Nov. 2002, pp. 117-121.
- [4] Borenstein, J.; Everett, H.R. & Feng, L. (1996). Navigating Mobile Robots: Sensors and Omni directional Mobile Robot – Design and Implementation Ioan Doroftei, Victor Grosu and Veaceslav Spinu “Gh. Asachi” Technical University of Iasi Romania Techniques. A K Peters, Ltd, MA, USA.
- [5] Ioan Doroftei; Victor Grosu and Veaceslav Spinu; “Omnidirectional mobile robot- Design and Implimentation” from “Gh.Asachi” Technical university of Iasi, Romania.

National Conference on Current Trends in Engineering, Science and Technology (NACCTEST-2018) Organized by GF's Godavari College of Engineering, Jalgaon *International Journal of Innovations in Engineering and Science, Special Conference Issue, 2018*
www.ijies.net

Sustainable Trend and Necessity for Future Smarter Nation by Smart Grid

Bipasa Roy Patra

Assistant Professor (Electrical)

Khandesh Bahuuddeshiya Sanstha's North Maharashtra Knowledge City

Jalgaon, India

akasvora@gmail.com

Abstract- This paper briefly discusses need and gradual evolution of Smart Grid and its development. Smart Grid is important as it leads us to energy independence and of course a sustainable economic growth. Growth of Smart Power Grid in India will slowly but surely take us towards fulfilling the dreams of former President Dr. A.P.J. Abdul Kalam, "Energy for all and Energy forever". According to its outlook, the smart grid is an upgrade of the common existing electricity grids that operate mostly to provide one-way power from several major power plants to a huge number of consumers but being friendly to both the utility as well as the consumers. This upgrade is expressed in the ability to operate in conditions of uncertainty in order to route the power supply in an optimal way that responds to a wide variety of situations, to encourage users in off-peak hours and charge premium rates from consumers who use energy during peak hours. The key to this capability is quick, accurate and two-way transmission of information between all parts of the grid. Situations that require fast response can occur at all parts of the grid – at the chain of production, transmission and consumption.

Keywords: Smart Grid, FACTS, ICT, Smart homes

I. INTRODUCTION

A smart grid (SG), also called smart electrical/power grid, intelligent grid, intelligrid, future grid intergrid, or intragrid, is an advancement of the 20th century power grid. In India bulky electrical power distribution system is used which is complex and growing rapidly at an alarming rate. Rate of GDP would lead the rise in demand by 3 times in next decade and 66% of which would be on-grid only [1]. By 2032, the expected demand of the Power would be 900GW [2], and this demand would be met significantly by renewable sources besides the conventional resources. The expected potential of renewable energy would be 183GW by the same time [4]. Along with the availability of power,

the reliability and efficiency also become prime concerns for the Indian power systems. The increase in demand would not only consists of conventional domestic and industrial type loads, but also few new unique loads like electric vehicle and power electronics loads which would contribute to a major part in demand growth. The source of the event could be in the environment (sudden cloudiness that decreases solar power, or a very hot day that increases the demand for air conditioning), in parts of the grid itself (sudden failures, the need for proactive maintenance) or in the demand (work hours compared to hours of rest).

Power generation and distribution the real-time information on costs, demands and supply of power will provide control at every level of the system. Consumers will both receive and contribute power to the smart grid from ultimately anywhere in the world. Large appropriations are being spent around the world to advance smart grid. In the U.S., bills have The smart grid will add monitoring, analysis, control and communication capabilities been passed nationally and at the state level to mandate renewable energy standards, funded by both government and industry .In The need for cross-industry research is immense. Smart grid queries of IEEE data resources have increased. Collaborations have begun between experts in diverse fields—electric analysis systems engineers with software developers, communications firm sand the computer systems experts—to develop technologies for new applications in distribution, communication, analysis and control. Millions of new products and devices will be required.

II. LITERATURE SURVEY

What is smart grid? The initial concept of SG started with the idea of advanced metering infrastructure (AMI) with the aim of improving demand-side management and

National Conference on Current Trends in Engineering, Science and Technology (NACCTEST-2018) Organized by GF's Godavari College of Engineering, Jalgaon
International Journal of Innovations in Engineering and Science, Special Conference Issue, 2018
 www.ijies.net

energy efficiency, and constructing self-healing reliable grid protection against malicious sabotage and natural disasters [13]. However, new requirements and demands drove the electricity industries, research organizations, and governments to rethink and expand the initially perceived scope of SG. The U.S. Energy Independence and Security Act of 2007 directed the National Institute of Standards and Technology (NIST) to coordinate the research and development of a framework to achieve interoperability of SG systems and devices.

1) *Motivation to build future smart grids*

We are facing energy deficiency in some countries which not only impacts economics, society and development of the country, but also results in the global warming. The drivers for change are both external to the network, like preparing for a low-carbon future by reducing greenhouse gas, as well as internal, like the need for replacement of an ageing infrastructure. Recently, energy saving and energy security have become major issues. One of the main external drivers is the European Union (EU) Energy and Climate Package, which has set out ambitious targets for year 2020 and beyond as [7]:

- 20% reduction of greenhouse gas emissions (compared to 1990 levels)
- 20% of RES in the EU 27 energy mix (today 6.5%)
- 20% reduction in the primary energy used (saving 13% compared to 2006 levels).

The EU's triple commitment to reduce CO₂ emissions by 20%, sourcing 20% of its total energy (transport, heating, lighting and electricity) from renewable sources and improving energy efficiency by 20%, all by year 2020; represent a considerable challenge for today's energy sector. A set of recent developments are about to change this picture and put the electricity networks under pressure to change. For the electricity grid, the triple commitment is even more challenging as it means that approximately 35% of all electricity will be generated from renewable sources. In addition, more electricity applications will appear in the future, such as the electrical vehicles and heat pumps coming into use today. This will have a considerable impact on the electricity grid. Generation of electrical energy, however, is currently the largest single source of carbon dioxide emissions, making a significant contribution to climate change.

2) *Power quality analysis of smart grid pilot*

According to report from the International Energy Agency (IEA) on Transmission and Distribution (T&D) losses in different countries during year 2010-11, the T&D losses in India are 23.65% against 9.8% average throughout the world [10]. India would be having six million electric vehicles on road by 2020 in [6] [7]. Further, in current scenario, distribution system in India is facing high Aggregate Technical and Commercial (AT&C) losses [2]. To evaluate the real benefits and to identify suitable technologies/models of the smart grid, Ministry of Power, Govt. of India proposed 14 pilot projects across the country with different functionalities of smart grid. At present all these pilot projects are under initial stage of implementation. Paducherry smart grid project [3] is one of the proposed pilots which are being developed jointly by Power Grid Corporation of India Limited (POWERGRID) along with open collaborators and Pondicherry Electricity Department (PED). The introduction of more power electronic devices gives increase in harmonic distortion [4]. Further the PV integration into the network influences both the voltage and network losses positively [5][6]. Power Quality (PQ) disturbances include those from short to long duration variations, harmonics, flickers, increased downtime, etc. and poor power quality would result in incurring high operation expenditure (Opex) cost. By monitoring and analyzing power quality, the cause of power system disturbance can be identified and improved before they cause interruptions. Various standards like IEEE-1547, IEEE-519, IEEE- 1159 etc. are laid down to monitor and control the quality of power supply. The indexes to monitor power quality are frequency variations, voltage variations, harmonics, flicker, power factor, etc. [7]

III. WORLD WIDE SCENARIO CURRENT STATE

We will now discuss the current state of various advanced components, as well as the core technologies upon which they depend. We must keep in mind, however, that while all of these technologies and components are needed for a modern grid, the timetable of expected availability varies as Power Electronics in Transmission and Distribution Systems

National Conference on Current Trends in Engineering, Science and Technology (NACCTEST-2018) Organized by GF's Godavari College of Engineering, Jalgaon
International Journal of Innovations in Engineering and Science, Special Conference Issue, 2018
 www.ijies.net

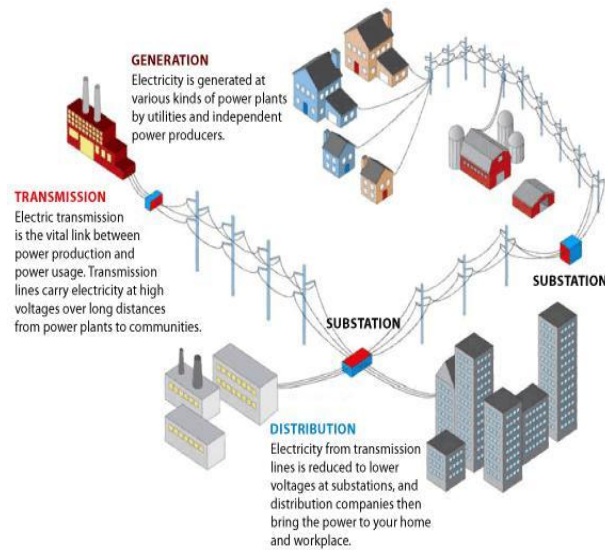

Fig. 1 Power Electronics in Transmission and Distribution Systems

1) In Japan

Japan is investing to renew the energy architecture, smart meters and smart grid Japan's work in the energy field is based on a unique combination of a solid scientific base combined with deep experience in Japan's energy business sector. Japan's electricity has undergone major overhaul, including the dissolution of vertically-integrated utilities, the creation of a nationwide grid operator, and incentives for distributed generation and demand response. Sustained reforms will drive the pace and scope of new opportunities for U.S. suppliers. Japan already has a highly reliable grid compared with the US, which needs more reliable and distributed networks across the nation to develop its smart grid system. Japan is developing its smart grid at a steady pace and has already been investing in grid projects for almost 20 years; over this period, there have been many developments.

With proper security controls, smart grids can prevent or minimize the negative impact of attacks by hackers and thus increase the reliability of the grid, thereby gaining the trust and meeting the satisfaction of users [10].

- a) Participation of various players such as system operators, retailers, consumers, resource aggregators
- b) Realization of secure, safe, and comfortable Smart Society by realizing the Smart Grid through the digital integration
- c) Whole optimization and high value-added creation

Flexible alternating current transmission system devices (FACTS devices include UPFC, DVAR, SVC, etc.) are good examples of advanced components that are based on power electronic technologies. FACTS have already demonstrated their worth in a number of transmission and distribution (T&D) applications, including the following Voltage control at various load conditions

- a) Power quality enhancement
- b) Reactive power balance
- c) Stability problems with energy transfer over long distances
- d) High voltage direct current (HVDC), a mature technology, also relies on power electronics to resolve many issues involving the power grid, such as these:
 - e) Coupling of asynchronous systems
 - f) Stability problems with energy transfer over long distances
 - g) Increase of short-circuit currents in meshed systems

- d) High reliable inter-convertibility of systems and Standardization of data structure
- e) Utilizing Big Data
- f) Cyber security
- g) Cooperation and optimization with centralized power plants, distributed power plants, and electricity apparatus of customers

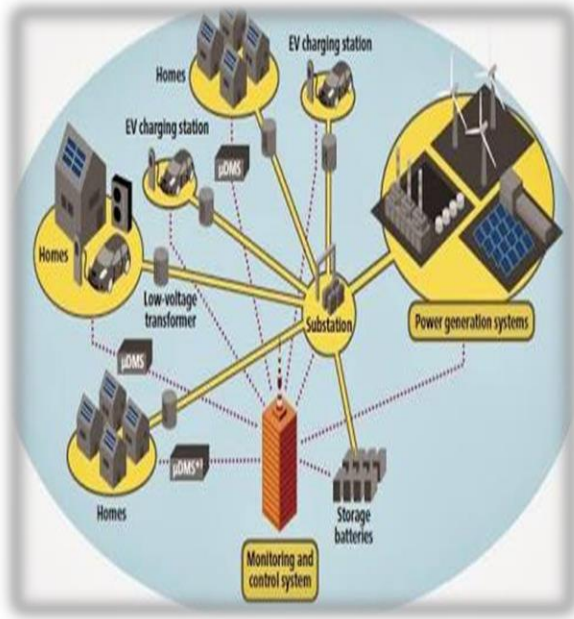

Fig. 2 Smart grid in Japan

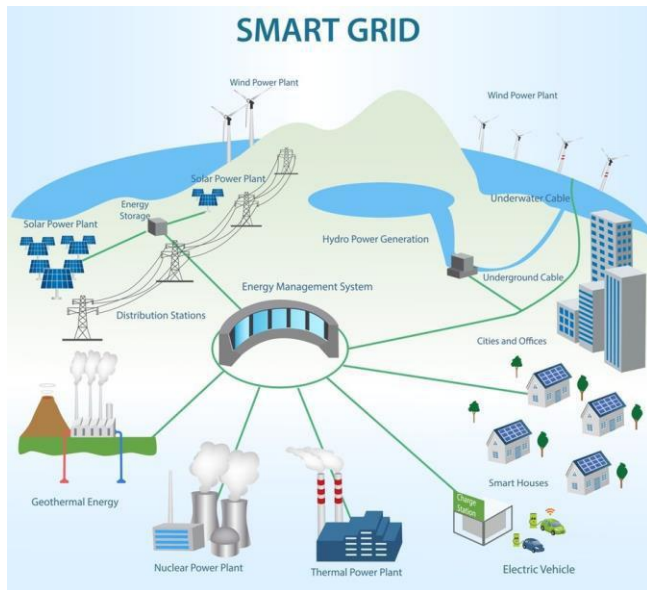

Fig. 3 Smart grid shutter stock

2) *In Usa*

The U.S. Department of Energy (DOE) is charged under the Energy Independence and Security Act of 2007 (EISA 2007) with modernizing the nation’s electricity grid to improve its reliability and efficiency. As part of this effort, DOE is also responsible for increasing awareness of our nation’s Smart Grid. Building upon *The Smart Grid: An Introduction*, a DOE-sponsored publication released in 2008 and available online at www.smartgrid.gov, this publication is one in a series of books designed to better acquaint discrete stakeholder groups with the promise and possibilities of the Smart Grid.

Stakeholder groups include Utilities, Regulators, Policymakers, Technology Providers, Consumer Advocates and Environmental Groups.

Support for the smart grid in the United States became federal policy with passage of the Energy Independence and Security Act of 2007[11]. The law set out \$100 million in funding per fiscal year from 2008–2012, established a matching program to states, utilities and consumers to build smart grid capabilities, and created a Grid Modernization Commission to

assess the benefits of demand response and to recommend needed protocol standards. The law also directed the National Institute of Standards and Technology to develop smart grid standards, which the Federal Energy Regulatory Commission (FERC) would then promulgate through official database.

The Department of Energy (DOE) issued a Notice of Intent and a draft Funding Opportunity Announcement (FOA) that will lay the groundwork for providing nearly \$4 billion in American Reinvestment and Recovery Act funds to support smart grid projects. The Notice of Intent was issued for DOE’s Smart Grid Investment Grant Program, which will provide grants of \$500,000 to \$20 million for smart grid technology deployments and grants of \$100,000 to \$5 million for the deployment of grid monitoring devices. The program will provide matching grants of up to 50% of the project cost, and the total funding for the program is \$3.375 billion. In addition, the draft FOA paves the way toward an offer of \$615 million to support demonstrations of regional smart grids, utility-scale energy storage systems, and grid monitoring devices.

National Conference on Current Trends in Engineering, Science and Technology (NACCTEST- 2018)
Organized by GF's Godavari College of Engineering, Jalgaon
International Journal of Innovations in Engineering and Science, Special Conference Issue, 2018
www.ijies.net

3) In India

The present power grid using the technology of 1970, but are connected to increase with the progress in different concept of power generation, problems with the power outages and theft, and also due to the demand, we need a modernized grid to fit the needs of the customers even in the to take the situation in claim hype, what can be called "Smart Grid". The Smart Grid performs various functions, so that it increases network stability, reliability, efficiency and ultimately reduces the processing power conduction losses. The Smart Grids are the two-way of the consumers who may have distributed generation. Various technologies such as sensors and measurement, use of advanced components are used for the successful functioning of the network. Confronted in this paper, Smart Grid, its features, technologies in smart grid used, implementation and challenges of Smart Grid in India are discussed.

A "smart grid" is a concept for transforming a power grid, with the modern communication, automated checks and other forms of information technology. It integrates new, innovative tools and technologies of generation, transmission and distribution to home appliances and equipment. The urgency for Smart Grids in India arises from the challenges that the industry is currently in front. India operates the third largest transmission and distribution network in the world, still faces a number of challenges, such as: inadequate access to electricity supply shortages (peak and energy)

IV. WORLD WIDE SCENARIO FUTURE STATE

The mix of generation will include large central power plants having a range of characteristics (e.g., heat rates, emissions, inertia, ramp rates, etc), in addition to distributed energy resources (many of the green variety) having a different set of performance characteristics. The combination of generation types will operate in a coordinated manner so as to optimize cost, efficiency and reliability and minimize environmental impact. Transmission capacity and reliability will be enhanced through the application and retrofitting of a variety of advanced components, many based on advanced power electronics and new types of conductors. Distribution systems will incorporate many new storage devices and sources and will employ new topologies, including micro grids. The

modern grid will employ a range of advanced components that will greatly enhance the performance of transmission and distribution systems.

TABLE I
A BRIEF COMPARISON BETWEEN THE EXISTING GRID AND THE SMART GRID [15]

Existing Grid	Smart Grid
Electromechanical	Digital
One-way communication	Two-way communication
Centralized generation	Distributed generation
Few sensors	Sensors throughout
Manual monitoring	Self-monitoring
Manual restoration	Self-healing
Failures and blackouts	Adaptive and islanding
Limited control	Pervasive control
Few customer choices	Many customer choices

Power quality will be improved through new technology and by seeking an optimal balance between grid and load characteristics Economical FACTS devices will make use of new low-cost power semiconductors having far greater energy-handling capacity than today's semiconductors. Distributed generation will be widely deployed and multiple units will be linked by communications to create dispatch able virtual machines. Superconductivity will be applied to fault current limiters, storage, low loss rotating machines, and lossless cables. Advanced metering and communications will enable a suite of demand response (DR) applications, including the integration of GFAs and plug-in hybrid electric vehicles (PHEVs). New energy storage technologies will be deployed as DER and as large central

CONCLUSION

It is obvious that with this revolution within the advanced infrastructure framework of SG, new management services and applications would emerge and eventually ease consumers' daily lives. For the smart management system, most of the existing works aim to improve energy efficiency, demand profile, utility, cost, and emission, based on the smart infrastructure by using optimization, machine learning, and game theory. The smart protection system involves the work related to system reliability, failure protection mechanism, security and privacy in SG.

Due to the potential importance of SG, this survey comprehensively explores the technologies used in SG. The

National Conference on Current Trends in Engineering, Science and Technology (NACCTEST- 2018)
 Organized by GF's Godavari College of Engineering, Jalgaon
International Journal of Innovations in Engineering and Science, Special Conference Issue, 2018
 www.ijies.net

surveys reveal the major SG projects/programs/trials and three major technical systems in SG. The paper outlined challenges and future research directions worth exploring for each of these three systems. It also divided the smart infrastructure into three subsystems: the smart energy subsystem, the smart information subsystem, and the smart communication subsystem. For the smart energy subsystem, we have reviewed the work on power generation, transmission, and distribution. The paper has also described two important new grid paradigms: micro grid and G2V/V2G. For the smart information subsystem, and reviewed the work on information metering, measurement, and management. For the smart communication subsystem, the wireless and wired communication technologies, and the end-to-end communication management has also been considered. In brief, in the transition from the conventional power grid to the SG, thus will replace a physical infrastructure with a digital one. The needs and changes present the power industry with one of the biggest challenges it has ever faced [14]. Hence it leads to successful comparison and one can find all the technical specifications in one paper. The paper may appear quite simple but it requires tough survey of various papers and technical articles. This paper also allows the reader to understand the hidden potential of all the energy sources and allows a wide future scope about what all can be done. So one needs to primarily focus upon the new developing trends in this field and help the government to complete its proposed projects.

REFERENCES

- [1] Lahiri, R.N, Sinha. A, Chowdhury. S.P, Importance of distribution automation system for Indian power utility, IEEE Power & Energy PES'09.
- [2] KrishnaRao, M.V. Pandurangam, J.V. Peri, Clinard, K.N. ,Development and evolution of a distribution automation system for and Indian utility, IEEE Transaction on Power Delivery, Vol.10, no.1, 1995
- [3] Ramakrishna Kappagantu, Dr.SubirSen, Mahesh.M, Dr. S. Arul Daniel ,Smart Grid Implementation in India – A Case Study of Puducherry Pilot Project, in International Journal of Engineering, Science and Technology, Vol. 7, no. 3, p. 94-101, July2015.
- [4] SjeffCobben, Wil Kling and JohannaMyrzik, The Making and Purpose of Harmonic Fingerprints, in CIREN International conf. on Electricity Distribution, Vienna, May-2007.
- [5] Jukka V. Paatero, and Peter D. Lund, Effect of large-scale photovoltaic power integration of electricity distribution networks, in Renewable Energy, Vol. 32, no.2, February-2007.
- [6] Joakim Widen, EwaWackelgard, JukkaPaatero and Peter Lund , Impact of distributed photovoltaics on network voltage: Stochastics simulation of three Swedish low-voltage distribution grid, in Electric Power System Research, vol. 80, no. 12, December-2010
- [7] Siahkali, H. , Power Quality Indexes for Continue and Discrete Disturbances in a Distribution Area, IEEE international conf. on Power and Energy, December-2008.
- [8] Muljadi, E. Butterfield C.P. Chacon, J. Romanowitz, H. ,Power Quality Aspects in a Wind Power Plant, IEEE Power Engineering Society General Meeting – 2006.
- [9] America. Presentation to the CA Public Interest Energy Research (PIER) Transmission Research Program (TRP[9] Dale T. Bradshaw, March 7, 2006. Results of the High Level Survey of Transmission R&D in North) Policy Advisor Committee (PAC)
- [10] Amy Poh Ai Ling, Masao Mukaidono, —Selection of Model in Developing Information Security Criteria on Smart Grid Security Systeml, Smart Grid Security and Communications, The Ninth International Symposium on Parallel and Distributed Processing with Applications (ISPA), No. 108, May 2011, Korea
- [11] "U.S. Energy Independence and Security Act of 2007" . Retrieved 2007-12-23.
- [12] International Journal of Scientific Research Engineering & Technology (IJSRET) ISSN: 2278-0882 IEERET-2014 Conference Proceeding, 3-4 November, 2014
- [13] F. Rahimi and A. Ipakchi. Demand response as a market resource under the smart grid paradigm. *IEEE Transactions on Smart Grid*,1(1):82–88, 2010.
- [14] A. Ipakchi and F. Albuyeh. Grid of the future. *IEEE Power and Energy Magazine*, 7(2):52–62, 2009.
- [15] H. Farhangi. The path of the smart grid. *IEEE Power and Energy Magazine*, 8(1):18–28, 2010.

National Conference on Current Trends in Engineering, Science and Technology (NACCTEST- 2018)
 Organized by GF's Godavari College of Engineering, Jalgaon
International Journal of Innovations in Engineering and Science, Special Conference Issue, 2018
www.ijies.net

Electrical Hoist

Dinesh Sangle¹, Bhushan Gunjal², Pankaj Shelake³, Rahul Rajput⁴, Mahesh Patil⁵,

^{1,2,3,4} Student of Electrical Department

⁵ Assistant Professor of Electrical Department

Gf'S Godavari College of Engineering, Jalgaon, India, 425003

maheshpatils@gmail.com

Abstract –Material handling plays vital role in any industry. The main object of this project is to invent Electrical Hoist with dynamic braking. A problem for shifting of light weight objects around 25 Kg to a height of about 30 meters from ground has been discussed here. To solve this issue across Godavari college of Engineering, an idea of using small electrical Hoist is presented. It basically involved design calculation for hoist motor and required accessories for it.

Keywords-dc series motor, rope, drum, dynamic braking.

INTRODUCTION

The Hoist mechanism shall include a driving motor, a gear reduction unit, two rope drums, ropes, shafts, gears, couplings, brakes, emergency manual arrangements, limit switches, gate position indicator (both analogue and digital), covers etc., all mounted on a fabricated steel frame. Electrical controls and all necessary electrical and mechanical accessories shall be provided for the satisfactory operation of the hoist. The hoist shall be capable of fully opening/closing the gate. Sufficient space shall be provided around the hoist components for repair/maintenance. A hoist is a device used for lifting or lowering a load by means of a drum or lift-wheel around which rope or chain wraps. It may be manually operated, electrically or pneumatically driven and may use chain, fiber or wire rope as its lifting medium. The most familiar form is an elevator, the car of which is raised and lowered by a hoist mechanism. Most hoists couple to their loads using a lifting hook. A sensor is used for avoiding action. There is no need of fuel and any wire extension for the power supply therefore it is pollution less and eco-friendly project.

METHODOLOGY

The single phase supply is given to the hoist through power supply converter, since we are using dc motor ac power is converted in dc by rectifier and filter in power supply and the output is applied to the motor is forward or reversed by the switch as the power applied to motor it runs.

The shaft of motor is coupled the pulley is coupled to the spur gear pulley with the help of chain. The spur gear arrangement runs according to the speed of the motor. As motor is switched ON, the wire or rope is wound or released as per direction selected by the control switch.

The rope is supply by a wire tare. The tare is rotating which is mounted on bearings to the frame stand by two end bearings, so that it will run freely according to the speed of the rolling shaft.

The rolling shaft is rotated when the motor switched ON. The spring wire is rolling in the rolling shaft due to the rotation of the rolling shaft. The length of the rolling rope is decided by the operator. The required length of the rope is rolled the motor is switched OFF.

Types of Braking in a DC Motor

The different types of motors that are available today and in this article, I shall discuss about the various techniques used to stop a DC Motor or to bring it to rest as we cut off the supply. Kindly see that the braking preferred to stop a DC Motor is Electrical Braking and not Mechanical Braking. In other words, the motor is stopped by the voltage and current action in the circuit rather than the mechanical friction brakes on the rotor.

National Conference on Current Trends in Engineering, Science and Technology (NACCTEST- 2018)
 Organized by GF's Godavari College of Engineering, Jalgaon
International Journal of Innovations in Engineering and Science, Special Conference Issue, 2018
 www.ijies.net

Basically, there are three types of electrical braking done in a DC Motor:-
 Regenerative Braking
 Dynamic Braking
 Plugging

1. Regenerative Braking

It is a form of braking in which the kinetic energy of the motor is returned to the power supply system. This type of braking is possible when the driven load forces the motor to run at a speed higher than its no-load speed with a constant excitation. The motor back emf E_b is greater than the supply voltage V , which reverses the direction of the motor armature current. The motor begins to operate as an electric generator. It is very interesting to note that regenerative braking cannot be used to stop a motor but to control its speed above the no-load speed of the motor driving the descending loads.

2. Plugging

It is also known as reverse current braking. The armature terminals or supply polarity of a separately excited DC motor or shunt DC motor when running are reversed. Therefore, the supply voltage V and the induced voltage E_b i.e. back emf will act in the same direction. The effective voltage across the armature will be $V + E_b$ which is almost twice the supply voltage.

Thus, the armature current is reversed and a high braking torque is produced. Plugging is a highly inefficient method of braking because, in addition to the power supplied by the load, the power supplied by the source is wasted in resistances.

It is used in elevators, printing press etc. These were the main three types of braking techniques preferred to stop a DC motor and used widely in industrial applications.

3. Dynamic Braking

It is also known as Rheostat braking. In this type of braking, the DC motor is disconnected from the supply and a braking resistor R_b is immediately connected across the armature. The motor will now work as a generator and produces the braking torque. During electric braking when the motor works as a generator, the kinetic energy stored in the rotating

parts of the motor and a connected load is converted into electrical energy. It is dissipated as heat in the braking resistance R_b and armature circuit resistance R_a . Dynamic Braking is an inefficient method of braking as all the generated energy is dissipated as heat in resistances.

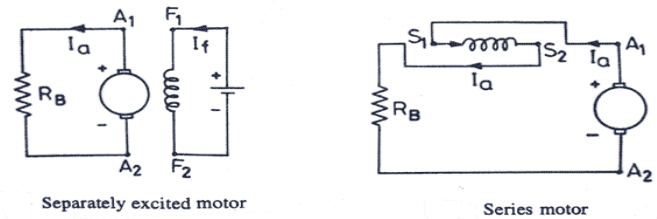

Fig1. Dynamic braking

Block diagram

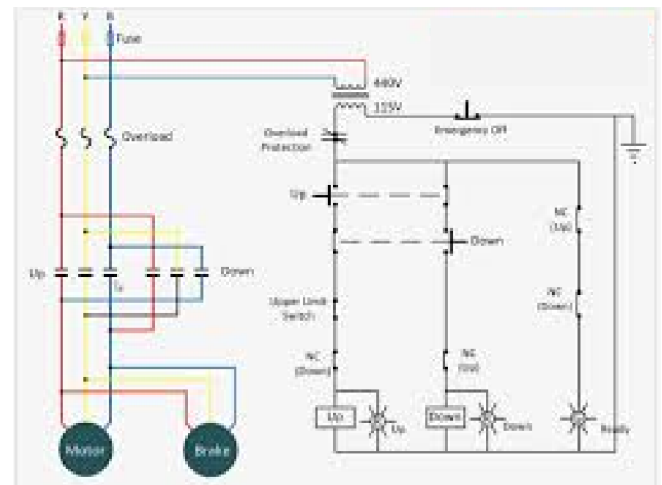

Fig2. Block diagram of the system



Fig3. Electrical hoist

National Conference on Current Trends in Engineering, Science and Technology (NACCTEST- 2018)
Organized by GF's Godavari College of Engineering, Jalgaon
International Journal of Innovations in Engineering and Science, Special Conference Issue, 2018
www.ijies.net

DESIGN ANALYSIS

The design requirements for the rope drum hoist are broadly mentioned as under as per IS: 6938:

- 1.) Capacity of hoist.
- 2.) Lift of Gate
- 3.) Operating speed
- 4.) Number of Drums : 2 (Two) with single/double layer of rope (for each hoist) with L.H. and R.H. groove on drum for two points lifting of gate
- 5.) Rope: IS:2266 , 6x37 Construction.

The Motor Selection:

Calculate the Force for lifting the material

$$M=50\text{kg}$$

$$G=9.81 \text{ m/s}^2$$

$$H=220$$

$$F= M.g$$

$$F=294.3 \text{ N}$$

Torque On Drum :

Let the width of the side arm be,

$$d:300\text{mm}$$

Torque(T)= Force(F)* Distance(d)

$$T=F.d$$

$$T= 294.3 *300$$

$$T=882.9\text{J}$$

Power for motor required at 30 RPM:

Angular velocity:30 rpm

$$\omega =30*2*\pi/60 \text{ rad/s}$$

$$=3.14 \text{ 1/s}$$

Power (P)= Torque (T) * Angular Velocity(ω)

$$P=T*\omega$$

$$=88.29 *3.14$$

$$=277.23 \text{ w}$$

Hence the final Specifications are,

$$\text{Torque}= 882.19 \text{ Nm}$$

Angular Velocity=30rpm

$$\text{Power} = 277.23 \text{ w}$$

Converting torque into Kgf

$$1\text{N is equal to } 0.101971621298 \text{ Kgf}88.29$$

$$*0.101971621298$$

We get =90.0 kgf

Hence,

Motor selected with the Inbulit gear box 30 rpm

Metal gear Torque of motor selected will be of 15 kgs

With shaft size of 8 mm.

CONCLUSION

The pulley DC motor showed an impressive performance. It had very high torque and low speed, the high performance of this motor originates from the gears used to reduce its speed. The calculations have been found to be very much in line with actual performance of the hoist.

REFERENCES

1. G.B.S. Narang, "Automobile Motoring", Khanna Publishers, Delhi, 1991, pp 671.
2. William H. Crowse, "Automobile Motoring".
3. Pneumatic Control System----Stroll & Bernaud, Tata McGraw Hill Publications, 1999.
4. Pneumatic System----Majumdar, New Age India International (P) Ltd Electric Crane.

National Conference on Current Trends in Engineering, Science and Technology (NACCTEST- 2018)
 Organized by GF's Godavari College of Engineering, Jalgaon
International Journal of Innovations in Engineering and Science, Special Conference Issue, 2018
www.ijies.net

Harmonic Elimination In Variable Frequency Drive By Shunt Hybrid Active Power Filter.

Miss.Yojana Bharambe¹, Prof.K.M.Mahajan²

¹ Student KCE COEIT Jalgaon,MS(India), yojanabharambe016@gmail.com

² HOD KCE COEIT,Jalgaon,MS(India)

Abstract – The review paper represents a Harmonic elimination in variable frequency drive by Shunt Hybrid Active Power Filter. It performs an effective harmonic compensation performance in a wide harmonic frequency band. The traditional method presented for SHAPF can't show the required performance, because it may include disturbances like as delays in phase because of feedback controller and measurement of each circuit, tolerances of passive filter circuits and harmonics in supply voltage. In new approach the controller, traditional feedback controller can be improved by using supply side individual current harmonics which are extracted by the synchronous reference frame method. To prevent the performance degradation effects of disturbances, P-I controllers are applied for each d-axis and q-axis components of separate current harmonics. The harmonic compensation performance of the proposed method is compared with the old one methods both theoretically and experimentally. The experimental conclusion is to verify and improve harmonic compensation performance in the new improved one control method.

Keywords- variable frequency drive, SHAF, P-I Controller, Harmonics

INTRODUCTION

Shunt hybrid active power filter (SHAPF) is a very effective device for compensating the harmonics in a small Active Power Filter in series with a single-tuned passive filter (PF). This technique combines the reactive power compensation and the ability of filtering harmonic with PF with the superior performance of APF in harmonic reduction. In that to the compensation performance, SHAPF method also comprises a less switching loss, a reduced converter size and a low cost of reduced dc-link voltage of APF SHAPF. In this

research paper, SHAPF method is formed from many branch PFs and an APF. Multiple branch PFs consists of two single-tuned filters tuned to the 5th and 7th harmonic frequencies and a 2nd-order high-pass filter. The APF is connected in series to PFs with transformer. The compensation control of harmonic of APF is achieved with a supply side current based detection controller, also called as a feedback controller, which calculating the output reference voltage of APF using only a linear proportional controller and the supply side current harmonics. By means of this controller, APF acts as a resistor in series with the supply impedance to force the flow of current harmonics to PF. In SHAPF topology is improved by using only a single-tuned PF and connecting APF directly in series to PF without a coupling transformer. In this paper, the tuning frequency of single-tuned PF is set to the 7th harmonic frequency instead of the 5th harmonic frequency so, the filtering of SHAPF is increased in higher harmonic frequencies, the size of Power filter reactor is minimised and the dc-link voltage level of APF is decreased. However, the shifting of PF tuning frequency causes an excessive performance degradation on the 5th current harmonic component. To cope with this problem, a feedforward controller is used in addition to the feedback controller. The feedforward controller generates a reference voltage using the 5th harmonic component of load current and the complex impedance of PF to increase the filtering performance of SHAPF on the 5th harmonic. Using the feedback controller with feed-forward controller, the circuit and arrangement of SHAPF which is integrated into a three-phase rectifier is presented in this paper. The multiple level inverter-based SHAPF is design for the harmonic minimization of variable frequency drive in The application of SHAPF in medium-voltage distribution network is investigated in SHAPF topology is proposed

National Conference on Current Trends in Engineering, Science and Technology (NACCTEST- 2018)
 Organized by GF's Godavari College of Engineering, Jalgaon
International Journal of Innovations in Engineering and Science, Special Conference Issue, 2018
 www.ijies.net

for the three-phase four-wire networks and an industrial uses of SHAPF for the harmonic problems of induction steel melting furnaces is proposed in load side detection-based controller which is the other compensation approach is proposed for SHAPF in several studies of harmonics. In this approach, Active Power Filter acts as a variable negative impedance used for improvement the filtering characteristic of PF by decreasing the equivalent impedance of PF in the harmonic frequencies. The load side detection-based controller for harmonic elimination requires a direct current control for APF. The inherited reactive current component and the second-order characteristic of single-tuned PF cause the use of complex current control methods for the effective harmonic compensation performance of SHAPF. Although the load side detection-based controller approach presents here is a favourable performance for SHAPF, the advanced controller requirements complicate the use of this control approach.

The of feedback controller provides a simple control scheme for SHAPF. In most of cases, it provides an admissible performance with the feedforward controller. Owing to these, the feedback controller approach becomes a traditional control scheme for SHAPF in the literature. Besides the advantages of the feedback controller, it suffers from the disturbances such as delays of the controller methods and phase errors caused by measurement sensors and circuitries. These all disturbances limit the increase of the feedback controller gain and degrade the compensation performance of SHAPF. In addition, the tolerances of PF components and voltage harmonics cause a severe reduction on the performance of the feedforward controller which is used to improve the performance of the feedback controller.

This paper proposes a multiple harmonic elimination-based feedback controller for SHAPF to increase the harmonic compensation performance. In the proposed controller, the conventional feedback controller is improved with multiple feedback loops which are applied for individual current harmonics. The proposed controller requires only the supply side current measurements to achieve the harmonic compensation control. The current harmonics are extracted from the supply side currents using the synchronous reference frame (SRF) method. The multiple feedback loops consist of proportional–integral (PI) controllers which regulate each d and q components

of individual current harmonics separately. With the help of PI controllers, the performance degrading effects of delays in the controller methods, phase errors caused by measurement circuitries, tolerances of components and supply voltage harmonics are prevented. The compensation performance of the proposed control method is compared with the traditional methods both theoretically and experimentally. The performance and stability of the proposed control method are verified with a 400 V laboratory prototype of SHAPF which compensates the harmonics and reactive power of a load group formed from 15 kW three-phase rectifiers and 10 kVAr inductive loads.

POWER CIRCUIT CONFIGURATION OF SHAPF

This circuit of the SHAPF is made up from the connection of the series single-tuned PF and an APF as shown in Fig. 1. Single-tuned Passive Filter is generally tuned to low-order harmonic frequencies to filter a part of dominant harmonic currents of the load side. In addition to that, it provide a capacitive reactive power for the reactive power demanded from the load side. Active power filter consists of a voltage source converter (VSC) and a dc-link capacitor bank. Voltage Source Converter is the main part of SHAPF that generates voltage across its terminals to compensate harmonics. The dc-link capacitor bank is used as energy storage element for harmonic compensation.

In traditional method of Active Power Filter topology, the dc-link voltage must be kept higher than the peak value of supply voltage. This method is used to control the active and flow of reactive power and harmonic injected current to grid. However, the capacitor of Power Filter holds the fundamental supply voltage across its terminals in SHAPF technology, so that APF keeps required voltage on dc link only for the harmonic compensation. Thus, the voltage ratings of VSC and that of the dc-link capacitor bank are significantly reduced by the series connection of PF and APF in SHAPF topology. By means of this advantage, low-voltage power switching devices and dc-link capacitors can be used, so that the size and the cost of APF can be reduced. Also the On-Off losses in APF are considerably decreased, thanks to the low-voltage stress on power switching devices

National Conference on Current Trends in Engineering, Science and Technology (NACCTEST- 2018)
 Organized by GF's Godavari College of Engineering, Jalgaon
International Journal of Innovations in Engineering and Science, Special Conference Issue, 2018
 www.ijies.net

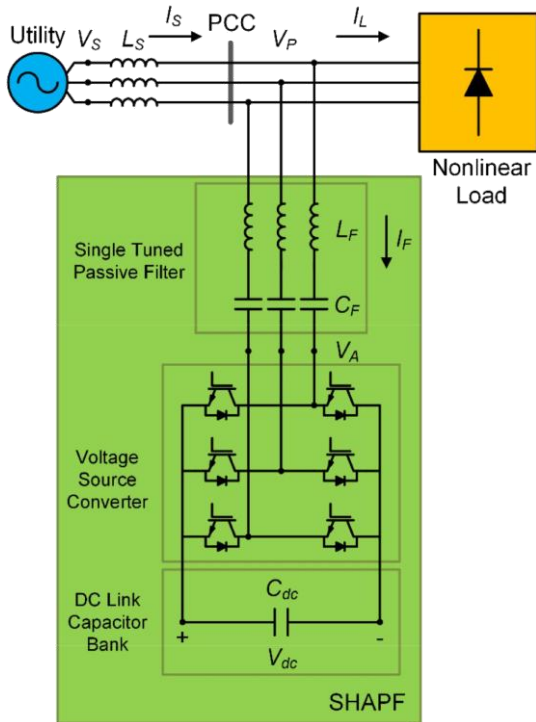

Fig. 1- fig shows the Power circuit Configuration

CONVENTIONAL CONTROL APPROACH

The study of feedback +5th harmonic feed-forward controller of Shunt hybrid active power filter is represented in this paper. This control strategy make use of the harmonic current of supply side for the reference compensated calculation of voltage. This current can be reveled with the help of synchronous fundamental reference frame method. This generated reference voltage which is to be compensated with the help of feedback controller is then calculated from using the gain of P-controller, K and the extracted harmonic current of supply side, I_{sh}^* . The feed-forward controller is made to make PF absorb all amount of the 5th harmonic load current by generating the required compensation voltage at the terminals of Active Power Filter. To apply the this control method, the 5th current harmonics are extracted using the load side current with the synchronous individual harmonic

reference frame method. The reference compensation voltage generated by the feedforward controller is then calculated on the dq reference domain from using the 5th harmonic of load current. The dc-link voltage controller

is necessary for providing and keeping the required dc-link voltage in constant level to achieve compensation. Voltage control of Dc-link Active Power Filter is provided by controlling the active power flow between ac and dc sides of converter. If APF generates a fundamental output voltage in phase with the fundamental leading current of PF, the active power flow is achieved and the dc-link capacitor is supplied. Thus, the generated DC link signal of PI controller is added to the q-component not in the d-component

PROPOSED CONTROL METHOD

In the method we are going to implement, harmonic elimination-based feedback control method we are applying in order to increase the performance of SHAPF. The block diagram of the this method is presented in Fig. In this control strategy, in the past method, feedback controller is improved with the feedback loops which are applied for individual current harmonics using PI controllers. The individual current harmonics are extracted up to 25th harmonics from the supply current using synchronous individual harmonic reference frame. The extracted d and q components of individual current harmonics are applied to PI controllers separately

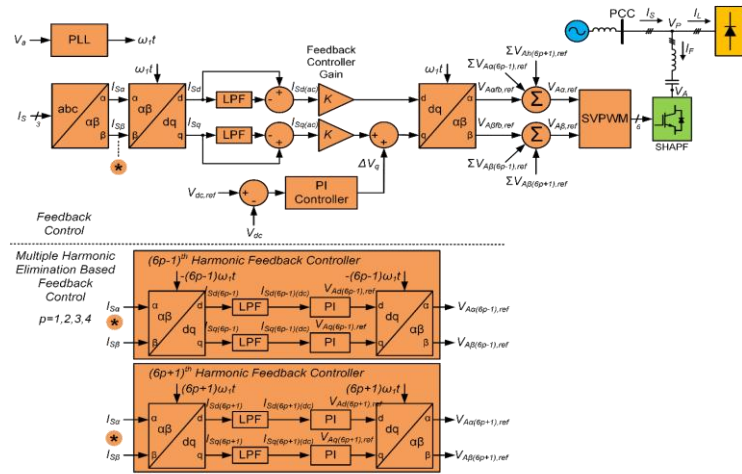

Block diagram of the proposed controller and its equivalent circuits

CONCLUSION

This paper presents a novel controller for SHAPF. In the proposed controller, the conventional feedback controller is improved with the multiple individual harmonic elimination-based feedback controllers. In this

National Conference on Current Trends in Engineering, Science and Technology (NACCTEST- 2018)
 Organized by GF's Godavari College of Engineering, Jalgaon
International Journal of Innovations in Engineering and Science, Special Conference Issue, 2018
 www.ijies.net

approach, PI controllers are applied to the d and q components of each individual current harmonics to increase the compensation performance. The advantages of the proposed controller over the conventional control methods are summarised as follows: the effect of phase delays caused by the reference generation method in the controller is eliminated; the effect of phase delays caused by the measurement sensors and circuitries is eliminated; the effect of PF component tolerances is compensated; an additional immunity is gained against the voltage harmonics; and the compensation of current harmonics can be performed with only the supply side current measurement, whereas the feedback + feedforward controller needs both supply and load side current measurements. The proposed controller provides an effective compensation performance for SHAPF..

filter', IEEE Trans. Power Electron., 2009, 24, (3), pp. 571–579

- [9] Veaceslav Spinu "Gh. Asachi" Technical University of Iasi Romania Techniques. A K Peters, Ltd, MA, USA.
- [10] Ioan Doroftei; Victor Grosu and Veaceslav Spinu; "Omnidirectional mobile robot- Design and Implimentation" from "Gh.Asachi" Technical university of Iasi, Romania.

REFERENCES

- [1] Akagi, H.: 'New trends in active filters for power conditioning', *IEEE Trans. Ind. Appl.*, 1996, **32**, (6), pp. 1312–132
- [2] Akagi, H.: 'Active and hybrid filters for power conditioning'. *Proc. of the IEEE Int. Symp. on Industrial Electronics, ISIE 2000, 2000*
- [3] Akagi, H.: 'Active harmonic filters', *Proc. IEEE*, 2005, **93**, (12), pp. 2128– 2141
- [4] Akagi, H.: 'The state-of-the-art of active filters for power conditioning'. *European Conf. on Power Electronics and Applications, 2005, 2005*
- [5] Fujita, H., Akagi, H.: 'A practical approach to harmonic compensation in power systems-series connection of passive and active filters', *IEEE Trans. Ind. Appl.*, 1991, **27**, (6), pp. 1020–1025
- [6] Srianthumrong, S., Akagi, H.: 'A medium-voltage transformerless AC/DC power conversion system consisting of a diode rectifier and a shunt hybrid filter', *IEEE Trans. Ind. Electron.*, 2003, **39**, (3), pp. 874–882
- [7] Wiroj, T., Hatada, T., Wada, K., et al.: 'Design and performance of a transformerless shunt hybrid filter integrated into a three-phase diode rectifier', *IEEE Trans. Power Electron.*, 2007, **22**, (5), pp. 1882–1889
- [8] Akagi, H., Hatada, T.: 'Voltage balancing control for a three-level diode-clamped converter in a medium-voltage transformerless hybrid active

National Conference on Current Trends in Engineering, Science and Technology (NACCTEST- 2018)
Organized by GF's Godavari College of Engineering, Jalgaon
International Journal of Innovations in Engineering and Science, Special Conference Issue, 2018
www.ijies.net

VSC-Based HVDC Transmission System: An Overview

Mr. Harish Patil¹, Prof. K. M. Mahajan²

¹PG Scholar, Electrical Engineering Department, KCE COEIT Jalgaon, MS, (India)

²Head, Electrical Engineering Department, KCE COEIT, Jalgaon, MS, (India)

¹harishmith@gmail.com

Abstract—The more and more increasing progress of high-voltage high power fully controlled semiconductor technology continue to have a important impact on the development of advanced power electronic equipment. Power electronic equipment is used to support optimized operations and efficient management of electrical grids. In this paper, an overview of the modern technology in the area of voltage source converter HVDC transmission system is provided. This paper also gives a list of VSC-based HVDC installations worldwide is included. It is confirmed that the continuous growth of power electronics presents cost efficient opportunities for the use to exploit, and HVDC remains a key technology. In particular, VSC-HVDC can address not only conventional network problem such as asynchronous network interconnections, back-to-back ac system linking, bulk power transmission and voltage/stability support to mention a few, but also niche markets such as the integration of large-scale renewable energy sources with the grid and a large amount of recently large onshore/offshore wind farms.

Keywords— HVDC links, HVDC system, VSC HVDC, etc

I. INTRODUCTION

In recent year, High Voltage Direct Current power supply technology has been retarded again. As compared to basic technology and traditional High Voltage Direct Current (HVDC) technology has an effective and reliable way of transmitting electrical power over long distances [1]. High Voltage Direct Current technology has certain characteristics which make it especially attractive for transmission system applications. HVDC transmission system is useful for bulk power delivery, long-distance transmission and long submarine cable crossings and asynchronous interconnections. In recent years, the number of HVDC system projects committed and several under consideration globally have increased and showing a

renewed interest in this High Voltage Direct Current technology. New converter designs have widened the voltage range of High Voltage Direct Current transmission system to include applications for offshore, underground, economic replacement of reliability in generation, and voltage stabilization. The development includes higher transmission voltage range up to ± 800 kV for weak system applications voltage-sourced converters with dynamic reactive power control and capacitor-commutated converters. This broader technology range has increased the HVDC applications and contributed to the recent growth of HVDC transmission [2]. The VSC based HVDC transmission technology is more flexible and suitable for construction of multi-terminal DC transmission and DC grids. The voltage source converter based HVDC transmission system has broad applications in the fields of the integration of renewable energy sources with the grid, the interconnection of urban electric grid and so on [3]. By connecting rectifier and inverter through DC cable or overhead transmission line, the power transmitted from sending end to the receiving end. Most project applications of Voltage Source Converter HVDC adopt cables to reduce the high fault possibility, radio interference and audible noise of overhead line [4].

HVDC systems is important technology, supporting to the modern power systems, which in many cases are fully partially deregulated in several countries [6]. In the near future, even higher incorporation of electrical grids and market driven developments are expected as, for instance, countries in the Middle-East, China, India and South America require infrastructure to power their growth [7]-[11]. Now a days, there are more than 92 HVDC projects worldwide transmitting more than 75GW of power employing two distinct technologies as follows [12]:

1. Line-commutated Converter- This is also called as Current-Source Converters (CSCs). Thyristors are used in this converter technology. This technology is well established for high power, typically around 1000MW, with the largest project being the Itaipu system in Brazil at 6300MW power level [12].

2. Forced-commutated Converters – This is also called as Voltage-Source Converters (VSCs). In this technology, gate-turn-off thyristors (GTOs) or in most industrial cases insulated gate bipolar transistors (IGBTs) are used. It is well established technology for medium power levels thus far, with the largest size project being the latest one named Estlink at 350MW level (Table 2) [12].

CSC-HVDC systems represent mature technology today (i.e., also referred to as “classic” HVDC) and recently, there have been a number of significant advances [13]. Table 1 gives the various types of fully-controlled high-power semiconductors.

TABLE 1
FULLY-CONTROLLED HIGH-POWER SEMICONDUCTORS

Acronym	Type	Full Name
IGBT	Transistor	Insulated Gate Bipolar Transistor
IEGT	Transistor	Injection Enhanced Gate Transistor
GTO	Thyristor	Gate Turn-off Thyristor
IGCT	Thyristor	Integrated Gate Commutated Thyristor
GCT	Thyristor	Gate Commutated Turn-off Thyristor

II. BASIC HVDC SYSTEM

HVDC transmission system is classified into two types such as VSC HVDC transmission system and LCC HVDC transmission system. The Line Commutated Converter (LCC) based HVDC system is also called as classical HVDC [14]. Voltage Source Converter HVDC is a new power transmission technology and Self turn-off devices. Voltage source converter provides a new choice for grid inter-connection [4].

A. Components of Basic HVDC System

A basic construction of HVDC transmission system is as shown in figure 1. This system consists of AC side filters, converters, transformers, DC side filters, reactors and DC transmission lines or cables [5].

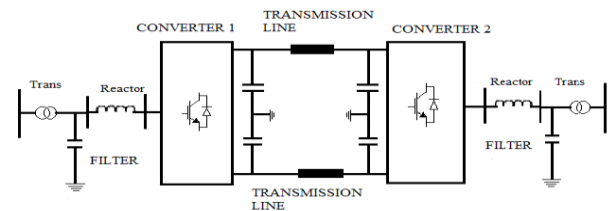

Fig.1 A Basic Structure Of HVDC System

1) Converters-

The converters play an important role in HVDC Transmission system. It performs two operations at receiving end and at sending end such as conversion from AC to DC like rectifier and DC to AC like inverter respectively. These converters are connected to the AC system through transformers at receiving end and at sending end. The current source converters with line commutated thyristors switches are used in basic HVDC converters system. For both conversions, i.e., rectification and inversion process a six-pulse valve bridge is used in basic High Voltage Direct Current system. Similarly, twelve pulse converter bridge circuits can be made by connecting two six pulse bridges circuit to each other. These bridges are connected separately to the receiving end and at the sending end of the AC system through transformers. These transformers are connected to AC system, one with Y-Δ winding structure and the other with Y-Y winding structure. Due to this, the distortion decreases in the AC systems which are caused by the HVDC converters [5].

2) Transformers-

The transformers connect the AC transmission network to the twelve valve bridge or six-pulse pulse Valve Bridge. The transformers adjust the AC voltage to a suitable level of the converters. The design of these transformers is depending on the power to be transmitted in the system.

3) AC Side Filters-

The converters of HVDC transmission system produce harmonic currents on the AC side these harmonic currents entering into the A.C system. These harmonic currents are limited by AC filters on AC side. In the process of conversion, the converters consume reactive power of the High Voltage DC system. This reactive power is partially compensated in the filter banks and remaining is provided by capacitor banks connected in the HVDC transmission system [5].

4) DC Side Filters-

The converters of the HVDC transmission system produce ripple on the DC voltage. These voltage ripples cause the interference to telephone lines near the DC line. There is no need of DC filters for pure cable transmission or for back to back HVDC stations but if overhead transmission lines are

used in HVDC system, it is necessary to install DC filters. Tuned filters and active DC filters are commonly used on DC side of HVDC transmission system [5].

5) *HVDC Overhead Transmission Lines or HVDC Cables-*

For submarine and underground transmission system normally HVDC cables are used. There is no length limitation exists for HVDC cables transmission system. There is no need of DC cables or overhead lines for a back to back HVDC transmission system. Due to environmental concern cables are used for connections over land [5].

B. HVDC SCHEMES

There are mainly three types of HVDC schemes. The selection of each scheme at planning stage depends on the operational requirements, flexibility of demand, reliability issue and cost. The following are the most common HVDC configuration schemes [14].

1) *Mono Polar HVDC Scheme*

In this scheme, a single line is used between the two converters. In mono polar HVDC scheme, either a positive or negative voltage is used for the transmission of voltage [14]. The ground or sea or metal can be generally used as return path. The mono polar HVDC scheme is shown in figure 2.

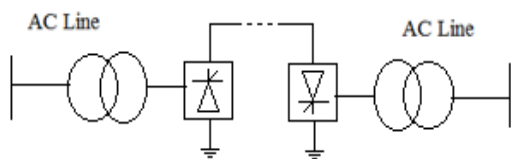

Fig.2 Mono Polar HVDC System

2) *Bi Polar HVDC Scheme*

In this scheme, power transmission is carried out using two conductors of opposite polarity. It is a combination of two mono polar HVDC systems. Due to this combination reliability of the system is increased. When one pole of the transmission system is removed, the other part resumes the normal operation using ground as a return path [14]. This scheme is as shown in figure 3.

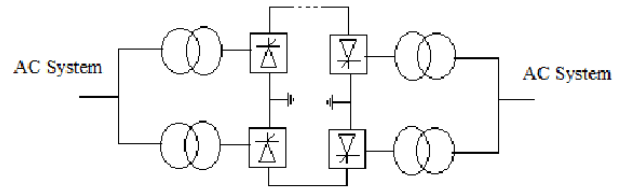

Fig.3 Bi polar HVDC System

3) *Homo Polar HVDC Scheme*

This is a zero-distance transmission system. The two converters are connected to each other without any DC line [14]. This scheme is as shown in figure 4.

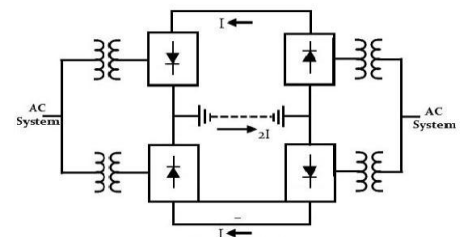

Fig.4 Homo Polar HVDC System

III. WORLDWIDE INSTALLATIONS OF VSC-HVDC PROJECT

VSC-HVDC can be effectively used in a number of key areas as follows [15]:

- 1) Small, Isolated Remote Loads;
- 2) Power Supply to Islands;
- 3) Infeed to City Centers;
- 4) Remote Small-Scale Generation;
- 5) Offshore Generation and Deep-Sea Crossings;
- 6) Multi-terminal Systems;
- 7) Independent control of both active and reactive power;
- 8) Supply of passive networks and black-start capability;
- 9) High dynamic performance.

The various projects worldwide where VSC-based HVDC systems have been successfully exploited are discussed. The projects have been designed and delivered by ABB [16] and are summarized in Table 2. They involve back-to-back systems (Eagle Pass, USA), wind energy applications (Gotland, Sweden), two controlled asynchronous connections for trading of electricity (Murray link and Direct link, Australia), power enhancement (Cross Sound link, USA) and the powering of an off-shore platform (Troll A, Norway). It should be noted that the DC voltage has reached $\pm 150\text{kV}$ and the largest system is at 350MW, making the VSC-HVDC a well-established technology in the medium power levels. Moreover, the experiences gained from the projects so far ensure that VSC-HVDC technology remains competitive and assists utilities

National Conference on Current Trends in Engineering, Science and Technology (NACCTEST- 2018)
Organized by GF's Godavari College of Engineering, Jalgaon
International Journal of Innovations in Engineering and Science, Special Conference Issue, 2018
www.ijies.net

worldwide in order to deliver efficient, reliable, economic, and where possible renewable energy to customers irrespective of how challenging the applications are..

IV. CONCLUSION

In this paper, recent advances of the VSC-based HVDC technology and an overview of state-of-art of VSC HVDC technology is introduced. It not only further enhances the advantage of VSC-HVDC, such as the fast dynamic response, independent active and reactive power control,

and ability of connecting to “black” network, but also eliminates some well-known drawbacks, like high switching losses and harmonics.. It is confirmed that developments associated with VSC-based HVDC technology have delivered systems at voltage levels up to 350 kV and power levels up to 400 MW. VSC-HVDC undoubtedly will continue to provide solutions in many areas of the power systems where installations necessitate proven solutions.

TABLE 2 SUMMARY OF WORLDWIDE VSC-HVDC PROJECT

Project Name	Year	Power Rating	Ac Voltage	DC Voltage	Length Of Dc Cables
Hallsjon, Sweden	1997	3 MW	10 kV (both ends)	± 10 kV	10 km Overhead lines
Gotland HVDC light, Sweden	1999	50 MW	80 kV (both ends)	± 80 kV	2 × 70 km Submarine cables
Eagle Pass, USA	2000	36MW	132 kV (both sides)	± 15.9kV	
Tjaereborg, Denmark	2000	7.2 MW	10.5 kV (both sides)	± 9 kV	4 × 4.3 km Submarine cables
Direct Link, Australia	2000	180 MW	110 kV (Bungalora) 132kV(Mullumbimby)	± 80 kV	6 × 59 km Underground cable
Murray Link, Australia	2002	220 MW	132 kV (Berri) 220 kV (Red Cliffs)	± 150 kV	2 × 180 km Underground cable
Cross Sound, USA	2002	330 MW	345 kV (New Heaven) 138 kV (Shoreham)	± 150 kV	2 × 40 km Submarine cables
Troll offshore, Norway	2005	84 MW	132 kV (Kollsnes) 56 kV (Troll)	± 60 kV	4 × 70 km Submarine cables
Estlink, Estonia Finland	2006	350 MW	330 kV (Estonia) 400 kV (Finland)	± 150 kV	2 × 31 km Underground 2 × 74 km Submarine
Valhall offshore, Norway	2009	78 MW	300 kV (Lista) 11 kV (Valhall)	150 kV	292 km Submarine cables

REFERENCES

[1] Danhua Liu, Tongzhen Wei, QunhaiHuo, Lixin Wu, “ DC Side Line-to-line Fault Analysis of VSC- HVDC and DC- fault-clearing Methods”, *IEEE 5th International Conference on Electric Utility Deregulation and Restructuring and Power Technologies*, 2015, 2395-2399 .
[2] M. P. Bahrman,“ HVDC Transmission Overview”, *IEEE / PES Transmission and Distribution Conference and Exposition* ,2008, 1-7
[3] Yi Wang, Ziguang Zhang, YuagHei, Xiangyu Zhang,“ Pole-to-Ground Fault Analysis in Transmission Line of DC Grids Based on VSC ”, *IEEE 8th International Power Electronics and Motion Control Conference (IPEMC-ECCE Asia)*, 2016, 2028-2032.
[4] Manish Kumar, Manjeet and PoojaKhatri, “Study of Faults On HVDC Transmission Lines”, *Golden Research Thoughts*, 3(8), 2014, 1-11.
[5] Ashwini K. Khairnar, Dr. P. J. Shah, “Study of Various Types of Faults in HVDC Transmission System”, *International Conference on Global Trends in*

Signal Processing, Information Computing and Communication ICSPICC (Technically Sponsored by IEEE Bombay Section), Proceeding, 2016.
[6] G.C. Loehr and A. Casazza (Edited), “The evolution of electric power transmission under deregulation: Selected readings”, *IEEE Press*, 1999.
[7] T.J. Hammons, M. Willingham, K.N. Mak, M. Da Silva, M. Morozowski, and B.K. Blyden, “Generation and transmission improvements in developing countries”, *IEEE Trans. on Energy Conversion*, 14(3), 1999, 760-765.
[8] A.M.H.A. Karim, N.H.A. Maskati and S. Sud, “Status of Gulf co-operation council (GCC) electricity grid system interconnection”, *Proc. of IEEE Power Engineering Society General Meeting*, 2(2), 2004,1385-1388.
[9] T. J. Hammons, D. Woodford, J. Loughtan, M. Chamia, J. Donahoe, D. Povh, B. Bisewski, W. Long, “Role of HVDC transmission in future energy development”, *IEEE Power Engineering Review*, 20(2), 2000, 10-25.
[10] L. Weimers, “AC or DC: which way should China go?” *Modern Power Systems*, 25(8), 2005, 11-17.
[11] C. Ashmore, “Transmit the light fantastic”, *IET, Power Engineer*, 20(2), 2006, 24-27.

National Conference on Current Trends in Engineering, Science and Technology (NACCTEST- 2018)
Organized by GF's Godavari College of Engineering, Jalgaon
International Journal of Innovations in Engineering and Science, Special Conference Issue, 2018
www.ijies.net

- [12] L. Carlsson, "Classical HVDC: still continuing to evolve", *Modern Power Systems*, 22(6), 2002, 19-21.
- [13] Koganti Sri Lakshmi, G. Sravanthi, L. Ramadevi, "A Review Paper on Technical Data of Present HVDC Links in India", *International Journal on Recent and Innovation Trends in Computing and (IJRITCC)* ,3(4), 2015, 1985-1991.

National Conference on Current Trends in Engineering, Science and Technology (NACCTEST- 2018)
 Organized by GF's Godavari College of Engineering, Jalgaon
International Journal of Innovations in Engineering and Science, Special Conference Issue, 2018
www.ijies.net

Design of Three Phase Induction Motor with Pole Change Array

Hitesh Patil¹, Manoj Thelari², Devendra Chaudhari³, Bhushan Patil⁴, Atul Barhate⁵

^{1,2,3,4}Students, Electrical Engineering Department, ⁵Assistant Professor, Electrical Engineering Department Gf's, GCOE Jalgaon, Maharashtra, 425001
atbarhate@gmail.com

Abstract – Three Phase induction motor are employed in almost all industry because of its simple construction and easy operation. Efficiency of induction motor is affected by its fix losses and variable losses which mainly depend upon input supply voltage and load current respectively. And attempt is made to minimize the iron losses using the permanent magnet ferrite. A new three phase induction motor using return pole technology is proposed in this paper whose stator consist of two three phase winding accommodated in the same core and rotor is use as squirrel cage rotor with ferrite material on its periphery. Shaft lode are categorized as low, medium and high, stator winding are energized through control based and lode demand when compare to convention to induction motor, the motor efficiency and power factor are improve. Another approach of this machine is that ferrite layer on the rotor periphery will reduce the motor loss which result improving the motor efficiency.

INTRODUCTION

Induction motors are the most widely used motors for appliances, industrial control, and automation hence, they are often called the workhorse of the motion industry. They are robust, reliable, and durable. When power is supplied to an induction motor at the recommended specifications, it runs at iterated speed. However, many applications need variable speed operations. Historically, mechanical gear systems were used to obtain variable speed. Recently, electronic power and control systems have matured tallow these components to be used for motor control in place of mechanical gears. These electronics not only control the

motor's speed, but can improve the motor's dynamic and steady state characteristics. In addition, electronics can

reduce the system's average power consumption and noise generation of the motor. Induction motor control is complex due to its nonlinear characteristics. While there are different methods for control, Variable Voltage Variable Frequency or Volts/Hertz is the most common method of speed control in open loop. This method is most suitable for applications without position control requirements or the need for high accuracy of speed control.

However, AC motor speed control requires either varying the magnetic flux or changing the number of poles on the motor. Even decades after the induction motor gained widespread use, changing the frequency for speed control remained an extremely difficult task and the physical construction of the motor prevented manufacturers from creating motors with more than two speeds.

As a result, DC motors were necessary where accurate speed control and significant power output were required. In contrast to AC motor speed control requirements, DC motor speed control was achieved by inserting a rheostat into the low-power DC field circuit, which was feasible with available technology. These simple motor controls varied the speed and torque, and were the most economical way to do so for a number of decades. some electrical devices which need variable frequency than the fixed

supply frequency. The induction motors are one of the best example for variable frequency drives.

NECESSITY

Induction motors are widely used in many residential, industrial, Commercial, and utility applications. Single-phase induction motors are widely used in home appliances and industrial control. A variable frequency drive is a system for controlling the speed of a rotational or linear alternating current (AC) electric motor by controlling the frequency of the electrical power supplied to the motor. A variable frequency drive is a specific type of adjustable-speed drive. Variable-frequency drives are also known as adjustable-frequency drives (AFD), variable-speed drives (VSD), AC drives, micro drives or inverter drives. The multispeed operation and multipurpose operation are provided by controlling the speed of these motors. In the previous days, the variable speed drives had various limitations such as larger space, poor efficiencies, lower speed and etc. But the invention of power electronics devices change the situation so now variable speed drive are constructed in smaller size, high efficiency and high reliability. In this we explain the basic concept of speed control and v/f ratio control, generic topologies, control technique of speed control.

PRINCIPLE OF OPERATION

In both induction and synchronous motors, the AC power supplied to the motor's stator creates a magnetic field that rotates in synchronism with the AC oscillations. Whereas a synchronous motor's rotor turns at the same rate as the stator field, an induction motor's rotor rotates at a somewhat slower speed than the stator field. The induction motor stator's magnetic field is therefore changing or rotating relative to the rotor. This induces an opposing current in the induction motor, and the third a true synchronous motor with separately excited DC supply to rotor winding.

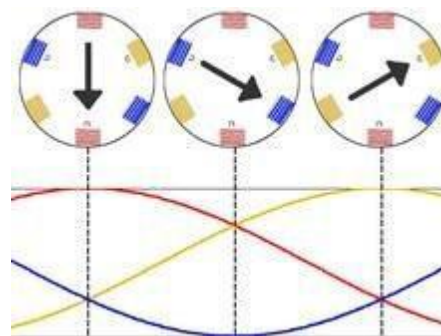

The cause of induced current in the rotor windings is the rotating stator magnetic field, so to oppose the change in rotor-winding currents the rotor will start to rotate in the direction of the rotating stator magnetic field. The rotor accelerates until the magnitude of induced rotor current and torque balances the applied mechanical load on the rotation of the rotor. Since rotation at synchronous speed would result in no induced rotor current, an induction motor always operates slightly slower than synchronous speed. The difference, or "slip," between actual and synchronous speed varies from about 0.5 to 5.0% for standard Design B torque curve induction motors.[30] The induction motor's essential character is that it is created solely by induction instead of being separately excited as in synchronous or DC machines or being self-magnetized as in permanent magnet motors.

For rotor currents to be induced, the speed of the physical rotor must be lower than that of the stator's rotating magnetic field (); otherwise the magnetic field would not be moving relative to the rotor conductors and no currents would be induced. As the speed of the rotor drops below synchronous speed, the rotation rate of the magnetic field in the rotor increases, inducing more current in the windings and creating more torque. The ratio between the rotation rate of the magnetic field induced in the rotor and the rotation rate of the stator's rotating field is called "slip". Under load, the speed drops and the slip increases enough to create sufficient torque to turn the load. For this reason, induction motors are sometimes referred to as "asynchronous motors".

An induction motor can be used as an induction generator, or it can be unrolled to form a linear induction motor which can directly generate linear motion.

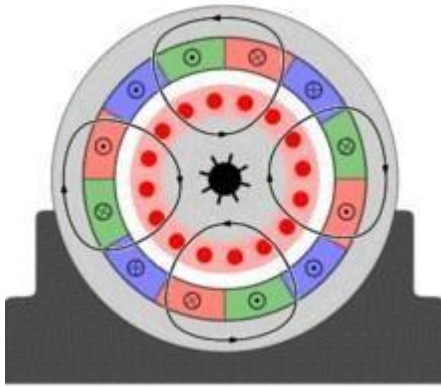

For example, for a four-pole three-phase motor, $n_s = 4$ and $n_s = 1,500$ and $1,800$, RPM synchronous speed, respectively, for 50 Hz and 60 Hz supply systems.

The two figures at right and left above each illustrate a 2-pole 3-phase machine consisting of three pole-pairs with each pole set 60° apart.

Slip

Slip, s , is defined as the difference between synchronous speed and operating speed, at the same frequency, expressed in rpm, or in percentage or ratio of synchronous speed.

STANDARD TORQUE

The typical speed-torque relationship of a standard NEMA Design B polyphase induction motor is as shown in the curve at right. Suitable for most low performance loads such as centrifugal pumps and fans, Design B motors are constrained by the following typical torque ranges

- Breakdown torque (peak torque), 175-300% of rated torque Locked-rotor torque (torque at 100% slip), 75-275% of rated torque Pull-up torque, 65-190% of rated torque.
- Over a motor's normal load range, the torque's slope is approximately linear or proportional to slip because the value of rotor resistance divided by slip,

In two-pole single-phase motors, the torque goes to zero at 100% slip (zero speed), so these require alterations to the stator such as shaded-poles to provide starting torque. A single phase induction motor requires separate starting circuitry to provide a rotating field to the motor. The normal running winding within such a single-phase motor can cause the rotor to turn in either direction, so the starting circuit determines the operating direction.

In certain smaller single-phase motors, starting is done by means of a shaded pole with a copper wire tu around part of the pole. The current induced in this turn lags behind the supply current, creating a delayed magnetic field around the shaded part of the pole face. This imparts sufficient rotational field energy to start the motor.

These motors are typically used in applications such as desk fans and record players, as the required starting torque is low, and the low efficiency is tolerable relative to the reduced cost of the motor and starting method compared to other AC motor designs.

Larger single phase motors are split-phase motors and have a second stator winding fed with out-of-phase current; such currents may be created by feeding the winding through a capacitor or having it receive different values of inductance and resistance from the main winding. In capacitor-start designs, the second winding is disconnected once the motor is up to speed, usually either by a centrifugal switch acting on weights on the motor shaft or a thermistor which heats up and increases its resistance, reducing the current through the second winding to an insignificant level. The capacitor-run designs keep the second winding on when running, improving torque. A resistance start design uses a starter inserted in series with the starting winding, creating reactance.

Self-starting polyphase induction motors produce torque even at standstill. Available squirrel cage induction motor starting methods include direct-on-line starting, reduced-voltage reactor or auto-transformer starting star-delta starting or, increasingly, new solid-state soft assemblies and, of course, VFDs.

Polyphase motors have rotor bars shaped to give different speed-torque characteristics. The current distribution within the rotor bars varies depending on the frequency of the induced current. At standstill, the rotor current is the same frequency as the stator current, and tends to travel at the outermost parts of the cage rotor bars (by skin effect). The different bar shapes can give usefully different speed-torque characteristics as well as some control over the inrush current at startup.

Although polyphase motors are inherently self-starting, their starting and pull-up torque design limits must be high enough to overcome actual load conditions.

In wound rotor motors, rotor circuit connection through slip rings to external resistances allows change speed.

CONSTRUCTION

The stator of an induction motor consists of poles carrying supply current to induce a magnetic field that penetrates the rotor. To optimize the distribution of the magnetic field, windings are distributed in slots around the stator, with the magnetic field having the same number of north and south poles. Induction motors are most commonly run on single-phase or three-phase power, but two-phase motors exist; in their induction motors can have any number of phases. Many single-phase motors having two windings can be viewed as two-phase motors, since a capacitor is used to generate a second power phase 90° from the single phase supply and feeds it to the

second motor winding. Single-phase motors require some mechanism produce a rotating field on startup. Cage induction motor rotor's conductor bars are typically skewed avoid magnetic locking.

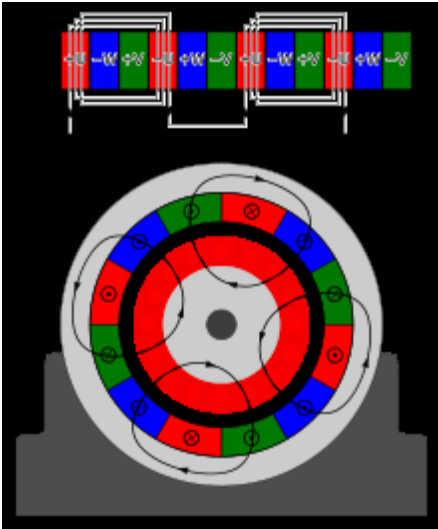

Typical winding pattern for a threephase (U, V, W), four-pole motor. Note the interleaving of the pole windings and the resulting quadrupole field

Power factor:-

The power factor of induction motors varies with load, typically from around 0.85 or 0.90 at full load to as low as about 0.20 at no-load, due to stator and rotor leakage and magnetizing reactances. Power factor can be improved by connecting capacitors either on an individual motor basis or, by preference, on a common bus covering several motors. For economic and other considerations, power systems are rarely power factor corrected to unity power factor. [Power capacitor application with harmonic currents requires power system analysis to avoid harmonic resonance between capacitors and transformer and circuit reactances. Common bus power factor correction is recommended to minimize resonant risk and to simplify power system analysis.

Efficiency:-

(See also Energy savings) Full load motor efficiency varies from about 85% to 97%, related motor losses being broken down roughly as follows.

Friction and windage, 5–15%

Iron or core losses, 15–25%

Stator losses, 25–40%

Rotor losses, 15–25%

Stray load losses, 10–20%.

Various regulatory authorities in many countries have introduced and implemented legislation to encourage the manufacture and use of higher efficiency electric motors. There is existing and forthcoming legislation regarding the future mandatory use of premium-efficiency induction-type motors in defined equipment. For more information

DESIGN

KVA input $Q = Co D^2 L n$

The output coefficient $Co = \pi^2 B_{av} ac \times 10^{-3}$

$D^2 L = Q / Co$ (i)

The rating of induction motor is sometimes given horse power and therefore output equation should be express in terms of horse power .

The KVA input is

$Q = h.p \times 0.746 / \eta \cos \phi$

main dimension-

The product $D^2 L$ obtained from equation (i) is split up into its to two component D & L . the separation of D & L for induction motor is discussed below . The ratio of core length to pole pitch for various design features is :

Minimum cost - 1.5 to 2

Good power factor - 1.0 to 1.25

Good efficiency – 1.5

Good overall design – 1

$3Hp = 2.238 KW$

Determine the main dimensions no. of radial ventilating ducts number of stator slot and no. of turns per phase of 2.238 Kw, 400V 3 phase 4 pole, 50Hz squirrel cage induction motor to be started by star delta starter workout winding details

Assume average flux density in the gap = 0.45 Wb/m²

Ampere conductor per meter = 23000

Efficiency = 0.85

Power factor = 0.84

Winding factor = 0.955

Stacking factor = 0.9

Solution:-

KVA input $Q = KW / \eta \cos \phi$

$= 2.238 / (0.85 * 0.84) = 3.134$

The output coefficient $Co = \pi^2 B_{av} ac \times 10^{-3}$

$= 11 * 0.955 * 0.45 * 23000 * 10^{-3}$

$= 108.7$

Synchronous speed = $2f/p$

$= 2 * 50 / 4$

$= 25$ r.p.s

$D^2 L = Q / Co$

$= 3.134 / (108.7 * 25)$

$= 1.15 * 10^{-3} m^3$

For cheap design ratio , $L/\tau = 1.5$ to 2 taking L/τ

$L * p / \pi d = 1.5$ or $L/D = 1.5 * \pi / p = 1.178$

$D^2 L = 1.15 * 10^{-3}$ OR 1.178

$D = 0.09920$ m

$L = 1.15 * 10^{-3} / (0.099)^2$

$L = 0.116 \approx 0.12$ m

POLE PITCH $\tau = \pi * D / p$

$= \pi * 0.10 / 4$

$= 0.0785$ m

Net iron length () = $0.9(0.12 - 0.01)$

$= 0.099$ m

Turns per phase:-

$$\text{Flux per pole} = B_{av} * L (\tau)$$

$$= 0.45 * 0.12 * 0.0785$$

$$= 4.24 \times 10^{-3} \text{ Wb}$$

As the machine is started by a star delta starter ,it design for delta connection.

$$\text{Stator voltage per phase } E_s = 400\text{v}$$

$$\text{Stator turns per phase } T_s = E_s / (4.44 * f * \phi_m \text{ kws})$$

$$= 400 \sqrt{4.44 * 50 * 10^{-3} * 0.955} = 443.9 \text{ turns}$$

NUMBER OF STATOR SLOT

It is small sized machine and since semi enclosed slots are used for this machine the slot pitch can be lower than 15 mm .However,for mechanical reasons the slot pitch should not be below 10 mm

$$\text{number of stator slot per pole } q_s = 3$$

$$\text{Total number of stator slot } S_s = 3 * 4 * 3 = 36.$$

$$\text{Stator slot pitch } = Y_{ss} = \pi * 0.10 / 36 = 0.00872 = 8.72 \times 10^{-3}$$

$$\text{Total number of stator conductor} = 6T_s = 6 * 343 = 2058$$

$$\text{Conductors per slot } Z_{ss} = 20$$

$$58 / 36 = 57$$

$$\text{Actual number of turns per phase} = 3 * 6 * 57 / (2 * 3) = 342$$

WINDING DETAILS.

For small machine like this a single layer much winding placed in semi include slots is used . in a single layer winding is called occupies two slots and therefore no. of coils is equal to $36 / 2 = 18$

$$\text{No. of coils per phase} = 18 / 3 = 6$$

As there are 3 slots per phase on 9 slots work pole the coil span is 9 slots . coils having slots 1 is connected to coil side , 1+9 = 10 in slots 10 . actually the coil span in much winding should always be an odd no on terms of slots span . Here it is odd and is equal to slots per pole an therefore the coils are full pitch

DESIGN OF THREE HP MOTOR WITH TWO POLE

Determine the main dimensions no. of radial ventilating ducts number of stator slot and no. of turns per phase of 2.238 Kw, 400V 3 phase 2 pole, 50Hz squirrel cage induction motor to be started by star delta starter workout winding details

$$\text{Assume average flux density in the gap} = 0.45 \text{ Wb/m}^2$$

$$\text{Ampere conductor per meter} = 23000$$

$$\text{Efficiency} = 0.85$$

$$\text{Power factor} = 0.84$$

$$\text{Winding factor} = 0.955$$

$$\text{Stacking factor} = 0.9$$

Solution:-

$$\text{KVA input } Q = KW / \eta \cos \phi$$

$$= 2.238 / (0.85 * 0.84) = 3.134$$

$$\text{The output coefficient } C_o = \pi^2 B_{av} a c \times 10^{-3}$$

$$= 11 * 0.955 * 0.45 * 23000 * 10^{-3}$$

$$= 108.7$$

$$\text{Synchronous speed} = 2f/p$$

$$= 2 * 50 / 2$$

$$= 50 \text{ r.p.s}$$

$$D_2 L = Q / C_o$$

$$= 3.134 / (108.7 * 50)$$

$$= 0.576 * 10^{-3} \text{ m}^3$$

For cheap design ratio , L/(τ) = 1.5 to 2 taking L/(τ)

$$L * p / \pi d = 1.5 \text{ or } L/D = 1.5 * \pi / p = 2.356$$

$$D_2 L = 0.576 * 10^{-3} \text{ OR } 2.356$$

$$D = 0.0627 \text{ m}$$

$$L = 0.0576 * 10^{-3} / (0.0627)^2$$

$$L = 0.116 \approx 0.12 \text{ m}$$

$$\text{Pole pitch } \tau = \pi * D / p$$

$$= \pi * 0.07 / 2$$

$$= 0.098 \text{ m}$$

$$\text{Net iron length } () = 0.9(0.12 - 0.01)$$

$$= 0.099 \text{ m}$$

Turns per phase :-

$$\text{Flux per pole} = B_{av} * L ()$$

$$= 0.45 * 0.12 * 0.0785$$

$$= 4.24 \times 10^{-3} \text{ Wb}$$

As the machine is started by a star delta starter ,it design for delta connection.

$$\text{Stator voltage per phase } E_s = 400\text{v}$$

$$\text{Stator turns per phase } T_s = E_s / (4.44 * f * \phi_m \text{ kws})$$

$$= 400 \sqrt{4.44 * 50 * 10^{-3} * 0.955} = 443.9 \text{ turns}$$

Number of stator slot:-

It is small sized machine and since semi enclosed slots are used for this machine the slot pitch can be lower than 15 mm .However,for mechanical reasons the slot pitch should not be below 10 mm

$$\text{Taking number of stator slot per pole } q_s = 3$$

$$\text{Total number of stator slot } S_s = 3 * 4 * 3 = 36.$$

$$\text{Stator slot pitch } = Y_{ss} = \pi * 0.7 / 36 = 0.0610 = 6.108 \times 10^{-3}$$

$$\text{Total number of stator conductor} = 6T_s = 6 * 343 = 2058$$

$$\text{Conductors per slot } Z_{ss} = 20$$

$$58 / 36 = 57$$

$$\text{Actual number of turns per phase} = 3 * 6 * 57 / (2 * 3) = 342$$

Winding details:-

For small machine like this a single layer much winding placed in semi include slots is used . in a single layer winding is called occupies two slots and therefore no. of coils is equal to $36 / 2 = 18$

$$\text{No. of coils per phase} = 18 / 3 = 6$$

As there are 3 slots per phase on 9 slots work pole the coil span is 9 slots . coils having slots 1 is connected to coil side , 1+9 = 10 in slots 10 . actually the coil span in much winding should always be an odd no on terms of slots span . Here it is odd and is equal to slots per pole an therefore the coils are full pitch.

CONCLUSION

A Three Phase Induction Motor Is Basically a constant speed motor so it's difficult to control its speed the speed of induction motor is done at the cost decrease in efficiency and low electrical power factor before discussing the methods to control the speed of the three phase induction motor.

- A variety of pole changing induction motor techniques exist
- There are no techniques for regulating torque during the pole changing transition
- Issue during the pole changing transition
- - reduction in torque
- - Flux and torque tracking
- Requirement for methods to decrease torque reduction during the pole changing transition and preserve control
- Developed method to analyze a pole changing machine in terms of field orientation transformation

FUTURE WORK

Research is endless. The work done in this thesis could be further researched upon and extended by considering various other sophisticated advanced simulation tools, both in the hardware and in the software levels.

The developed control strategy is not only simple but also reliable and may be easy to implement in real-time applications using some interfacing cards such as the dSPACE, Data acquisition cards, TMSDSP cards, NI cards, etc. for control of various parameters and can also be combined with fuzzy, ANNs and rough sets for other applications. Genetic algorithms combined with fuzzy and neural networks can be considered a future entity.

Speed control of IMs using sliding mode control, model predictive control and multirate output feedback control strategies such as the periodic output feedback and fast output sampling feedback could also be used. Fault tolerant strategies can also be used as one of the options for checking robustness issues in speed control. The robustness of the proposed controllers could be further investigated using simulation studies for various parametric changes/variations. One of the robust control techniques, viz., the H_∞ control scheme, could be used as one of the future options along with hybrid controllers.

REFERENCES

1] IEC 60050 (Publication date: 1990-10). Section 411-31: Rotation Machinery - General, IEV ref. 411-31-10:

"Induction Machine - an asynchronous machine of which only one winding is energized". (<http://www.electropedia.org/iev/iev.nsf/display?openform&ievref=411-31-10>)

2] Babbage, C.; Herschel, J. F. W. (Jan 1825). "Account of the Repetition of M. Arago's Experiments on the Magnetism Manifested by Various Substances during the Act of Rotation" (<https://archive.org/stream/philtrans03806447/03806447#page/n0/mode/2up>). Philosophical Transactions of the Royal Society. 115 (0): 467–496. doi:10.1098/rstl.1825.0023 (<https://doi.org/10.1098/rstl.1825.0023>). Retrieved 2 December 2012.

3] A Course of electrical engineering Book of "Electrical machine design" Author by A.K.Sawhney.

Remote Monitoring of Distribution Transformer Using GSM Module

Shalaka A. Chavan¹, Mitali A. Gaikwad², Tejas V. Ganyarpawar³, Apurva A. Shinge⁴, Shubham D. Shirgaonkar⁵, Umesh Barhate⁶

^{1,2,3,4,5} Final Year B.Tech, Department of Electrical Engineering,

Dr. Babasaheb Ambedkar Technological University, Lonere, Raigad, Maharashtra State, India – 402103

⁶ Assitant Professor, Department of Electrical Engineering, umbarhate@gmail.com

Dr. Babasaheb Ambedkar Technological University, Lonere, Raigad, Maharashtra State, India - 402103

Abstract - In any Power System, the Transformer plays a vital role. Monitoring of the physical parameters of a transformer meets many challenges. At present, Distribution Transformers need development of the data-acquisition system that can be used for condition monitoring, which helps in fault detection as well as preventive factors. The main objective of the system presented in this paper is to monitor the parameters of the transformer remotely through Global System for Mobile (GSM), which will avoid need for any manual operator and thus reduce human efforts. We have proposed the embedded system design, to monitor parameters such as voltages, currents and temperatures. This System is remotely located at the transformer site in a control cabinet which collects and analyzes all data. This system performs tasks of reading sensors, analyzing data and remote monitoring. ATMEGA2560 Arduino is used to control, process and communicate between modules. The remote monitoring of the transformer through GSM is a time saving and effortless system.

Keywords: Transformer, GSM Module, Arduino, Transformer Health Monitoring, Power System.

1. INTRODUCTION

Transformers are the heart of the power system. Transformer is a static device used for raising or lowering the voltage of an A.C supply with equivalent reduction or increase in current, without change in frequency. Many types of transformers are used in the industries like, Generation transformer, Power transformer, Distribution transformer, Instrument transformer, etc. ^[1] However, in

this paper, we limit ourselves to monitoring of distribution transformer. A transformer will provide as much protection as is appropriate in accordance with its voltage and power rating and the significance of its application. Ex. Over-current protection in the outward appearance of fuse may be the only fortification provided to a small 100 kVA, 11kV/400V distribution transformer. ^[2]

Distribution transformers are the most expensive and strategic components of any power system. Due to the long lead time for repair of and replacement of transformers, a major goal of transformer protection is limiting the damage to a faulted transformer. Some protection functions, such as over-excitation protection and temperature-based protection, may aid this goal by identifying operating conditions that may cause transformer failure. Unexpected outages due to power transformer failures result in considerable costs. Transformers must be monitored in order to limit the damages due to abnormal currents and over voltages. The transformers installed in a power system have standardized ratings for short-time withstand current and short duration power frequency voltage. The role of monitoring is to ensure that these withstand limits are never be exceeded, thereby clearing the faults as fast as possible.

The monitoring devices or systems which are presently used for monitoring of distribution transformer have some problems and deficiencies. Few of them are mentioned below.

(1) Ordinary transformer measurement system generally detects a single transformer parameter, such as power, current, voltage, and phase. While some methods could detect multiple parameters, the time of acquisition and operation is too long, and testing speed is not fast enough.

(2) The detected data is not always sent in time to monitoring centers, which can increase the intensity of fault.

(3) A monitoring system can only monitor the operation state or guard against power stealth, and is not able to monitor all useful data of distribution transformers to reduce costs.

(4) Many monitoring systems use power carrier communication to send data, but the power carrier communication has some disadvantages: serious frequency interference, with the increase in distance the signal attenuation is serious, load changes bring about large electrical noises. So, if we use power carrier communication to send data, the real-time data transmission and reliability cannot be guaranteed.^[3]

This paper presents a system to detect and prevent failures and to monitor distribution transformers. To keep the authorities updated on the situation, we carry out monitoring of a transformer in order to keep a track of the various parameters.

2. TRANSFORMER FAULT ANALYSIS

A power transformer consists of a set of windings around a magnetic core. The windings are insulated from each other and the core. Operational stresses can cause failure of the transformer winding, insulation, and core. The power transformer windings and magnetic core are subjected to a number of different forces during operation:

1. Expansion and contraction caused by thermal cycling.
2. Vibration caused by flux in the core changing direction.
3. Localized heating caused by eddy currents in parts of the winding, induced by magnetic flux.
4. Impact forces caused by fault currents.
5. Thermal heating caused by overloading.

These operating limits only consider the thermal effects of transformer overload. Later, the capability limit was changed to include the mechanical effect of higher fault currents through the transformer. Distribution transformer faults produce physical forces that cause insulation wear. These effects are cumulative and should be considered over the life of the transformer. The following discussion highlights on different capability limits of transformer. In this paper, we propose to provide monitoring to the transformer from over-current, over-voltage and faults caused due to temperature rise.

2.1 Over Voltage/Under Voltage

The flux in the transformer core is directly proportional to the applied voltage and inversely proportional to the frequency. Over excitation can occur when the per-unit ratio of voltage to frequency (Volts/Hz) exceeds 1.05 p.u. at full load and 1.10 p.u. at no load. An increase in transformer terminal voltage or a decrease in frequency will result in an increase in the flux. Over excitation results in excess flux, which causes transformer heating and increases excitation current, noise, and vibration.

2.2 Over Current/Under Current

Over current is the current flowing through the transformer resulting from faults on the power system. Fault currents that do not include ground are generally in excess of four times full-load current; fault currents that include ground can be below the full-load current depending on the system grounding method. Over current conditions are typically short in duration (less than two seconds) because protection relays usually operate to isolate the faults from the power system. Overload, by contrast, is current drawn by load, a load current in excess of the transformer rating. In summary, loading large power transformers beyond their ratings can result in reduced dielectric integrity, thermal runaway condition (extreme case) of the contacts of the tap changer, and reduced mechanical strength in insulation of conductors and the transformer structure. Three factors, namely, water, oxygen, and heat, determine the insulation life of a transformer. Filters and other oil preservation systems control the water and oxygen content in the insulation, but heat is essentially a function of the ambient temperature and the load current. Current increases the hottest-spot temperature (and the oil temperature), and thereby decreases the insulation life span.

2.3 Temperature

Excessive load current alone may not result in damage to the transformer if the absolute temperature of the windings and transformer oil remains within specified limits. Transformer ratings are based on a 24-hour average ambient temperature of 30°C (86°F). Due to over voltage and over current, temperature of oil increases which causes failure of insulation of transformer winding.^[4]

3. DESIGN OF AURDINO BASED TRANSFORMER HEALTH CONDITION MONITORING KIT

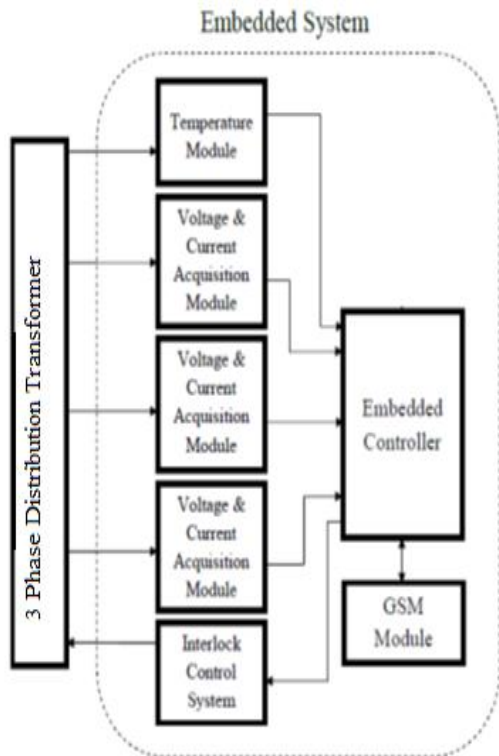

Figure 3.1 Functional Block Diagram

Figure 3.1 shows the architecture of the whole system for remote monitoring of the transformer. It consists of current transformer, transformer, IC LM35, Arduino ATMEGA 2560 and GSM Module. The embedded system is made up of some modules to acquire as well as to control the parameters of the transformer. Normally in transformer, failure occurs due to voltage and current fluctuation, overheating, etc.

First the sensors which are installed at the transformer side sense the various parameters of transformers. The function of the input device is to collect the processed input data, format the data, and transmit the data to the ATMEGA 2560 over a cable. The GSM Module is interfaced with the ATMEGA 2560 through which it uploads and downloads SMS messages that contain information related to transformer parameters and status. This GSM Module then sends this SMS to the mobile user containing information about parameters of the distribution transformer.

4. DESIGN OF SYSTEM

4.1 Hardware Implementation

In this system, power supply is used to provide the power to the sensors, Arduino, GSM. These are the main components used for designing the system. Arduino is automatically interfaced with GSM Module. GSM Module, through message, sends details of the parameters to the user.

4.1.1 ARDUINO MEGA 2560

It is a microcontroller board based on the AT-Mega 2560 (datasheet). It has 54 digital input/output pins (of which 14 can be used as PWM outputs), 16 analog inputs, 4 UARTs (hardware serial ports), a 16 MHz crystal oscillator, a USB connection, a power jack, an ICSP header, and a reset button. It contains everything needed to support the microcontroller; simply connect it to a computer with a USB cable or power it with a AC-to-DC adapter or battery to get started. The Arduino Mega can be powered via the USB connection or with an external power supply. The power source is selected automatically.^[3]

Features:

Microcontroller ATmega2560

- Operating Voltage: 5V
- Input Voltage (recommended): 7-12V
- Input Voltage (limits): 6-20V
- Digital I/O Pins: 54 (of which 14 provide PWM output)
- Analog Input Pins: 16
- DC Current per I/O Pin: 40 ma
- DC Current for 3.3V Pin: 50 ma
- Flash Memory: 256 KB of which 8 KB used by bootloader
- SRAM: 8 KB
- EEPROM: 4 KB
- Clock Speed: 16 MHz

4.1.2 Current and Voltage Transformer

Current and potential transformers are necessary for isolating the protection & control. The behaviour of current and voltage transformer during and after the occurrence of fault is critical in electrical protection since

error in signal from transformer can cause mal-operation of the relays.

4.1.3 Temperature Sensors LM35

- Calibrated directly in °Celsius (Centigrade)
- 0.5 °C accuracy guaranteed (at 25°C)
- Rated for full 55°C to 150 °C range
- Suitable for remote applications
- Low cost due to water-level trimming
- Operates from 4 to 30 volts
- Less than 60 mA current drain
- Low self-heating, 0.08°C in still air
- Low impedance output, 0.1 X

4.1.4 GSM Communication Unit

A GSM modem is a specialized type of modem which accepts a SIM card, and operates over a subscription to a mobile operator, just like a mobile phone. It is an effective communication technique that we prefer, which is based on the GSM communication protocol. This communication technique is available in all over the world. By using this communication technique we can send short messages to the owner's, manufacturer's and operator's mobile. This will let us relay the machine data, accidental alerts and the suggestive information.

Here we have used the SIM 900A module to use GSM communication. This module interfaces with the controller by using Serial Communication. This module also operates on the Arduino commands. These commands are used to send an SMS or calling the operator if emergencies arise. There are various commands used in the GSM communication. It is very effective as compared to other methods because various GSM operators are available. We have used this module for sending the emergency messages.

Features:

- High-Voltage Outputs: 50 V
- 500-mA-Rated Collector Current (Single Output)
- Inputs Compatible With Various Types of Logic
- 7 DPDT output relays.
- Relay Type: SPDT
- Relay control is simple TTL level digital signals.
- Relay Coil Voltage is 12V.

4.2 Software Implementation

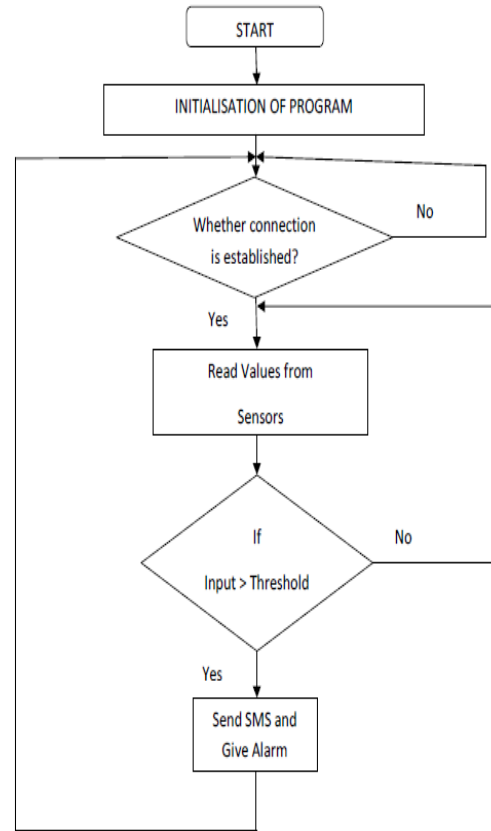

After the hardware implementation, the controller is programmed by using Arduino IDE software in sensing, processing, communications and controlling. Total flow of system is described. As 1st step is to initialize all the parameters to be monitored and analysed, then all the connections are verified by the controller and according to result of this step next task is performed. Proper connections indicate that the parameter monitoring process can be started. Parameter monitoring starts with extracting or acquiring data from different sensors. According to values of Currents, Voltages and Temperature, important decisions are taken by Master. For example, if voltage exceeds or reduces as compared to the threshold level then preventive steps like alarm are made on and an SMS is sent to respective authority. The controller converts the processed information to the output compatible format to the various sections like display unit, GSM unit and accordingly send the real-time as well point data through display.

CONCLUSION

Transformers are amongst the most generic and expensive piece of equipment of the transmission and distribution system. The GSM based monitoring of distribution transformer is quite useful as compared to manual monitoring and it is also reliable as it monitors temperature rise and load current manually. After receiving of message of any abnormality we can take action immediately to prevent any catastrophic failures of distribution transformers. In a distribution network, there are many distribution transformers and by associating each transformer with such system, we can easily figure out that which transformer is undergoing fault from the message sent to the mobile. We need not check all the transformers and corresponding phase currents and voltages and thus we can recover the system in less time. This type of remote observation of health condition of transformer not only increases the life of transformer but it also increases mean down time of transformer thereby increasing reliability and decreasing cost of power system operations.

Installation of the proposed system improves the quality of real time monitoring of transformer parameters and hence gives alarm for any steps to be taken to prevent the failure of Distribution Transformer and the different machines fed by it.

REFERENCES

- [1] S. Collese, P. di Tria, G. Morena, "short message service based applications in the GSM network," *Wireless Networks - Catching the Mobile Future.*, 5th IEEE International Symposium on , vol.3, no., pp.939-943 vol.3, 18-23 Sep 1994.
- [2] Xiao-hui Cheng and Yang Wang, "The remote monitoring system of transformer faultbased on The internet of Things," in *Computer Science and Network Technology (ICCSNT)*, 2011 International Conference on , vol.1, no., pp.84-87, 24-26 Dec. 2011.
- [3] R.V. Patil, D Kalantre, N Hirugade, A. More, A. Kakade, "Transformer Health Monitoring and Control through Arduino", *International Journal of Electrical, Electronics and data Communication*, Vol 5, Issue 1, Jan 2017.
- [4] Vadirajacharya K., A. Kharche, H. Kulakarni, V. Landage, "Transformer Health Condition Monitoring using GSM Technology", *International Journal of Scientific and Engineering Research*, Vol 3, Issue 12, Dec 2012.

National Conference on Current Trends in Engineering, Science and Technology (NACCTEST- 2018)
 Organized by GF's Godavari College of Engineering, Jalgaon
International Journal of Innovations in Engineering and Science, Special Conference Issue, 2018
www.ijies.net

INDUCTION MOTOR PROTECTION SYSTEM

Priyanka Koli¹, Shiva Pokhrel², Prof.Yojana Bharambe³

^{1,2} Student Godavari College of Engineering (Second Shift Poly) Jalgaon (MS)

³Lecturer Godavari College of Engineering (Second Shift Poly) Jalgaon (MS)

yojanabharambe016@gmail.com

INTRODUCTION

Abstract – This paper present the project designed to protect an induction motor from single phasing and over temperature. Providing a protection system to the motor is very important in industries as well as in laboratories, using lot of motors such that production is not hampered owing to failure of any motor. The basic idea for making this project is to provide safety to the industrial motor/pump/lift Motor etc. If any of the phases, out of the 3 phases is missing or if the temperature of the motor during operation exceeds permissible value, motor stops immediately. The system uses whole 3-Phase power supply where three single phase transformers are so connected to it. If any of the one phases is not available the corresponding transformer stops supplying power to the circuit. This leads to one of the four relays getting switched OFF. The main relay which is powered through a set of four relays gets disconnected because of one relay is trip. Thus the main relay that delivers 3 phase supply to the motor is not connected. A thermistor is connected to the motor body to sense the temperature. If the temperature increases then supply to the fourth relay is disconnected. Overload protection is so provided that protection against a running overcurrent that would cause overheating of the protected equipment. Hence we can also protect phase sequence, is the order in which the voltage waveforms of a polyphaser. AC source reach their respective peaks.

Induction motor is the most widely used motor in the industry due to its simple and rugged construction. It requires least maintenance as compare to the other electrical motors. Induction motor speed control is nowadays more easy and versatile due to the advancement motors. The protection of induction motor palys an important role in its long life service. Researches have done costly and limited protection for the stators windings protection, broken rotor bars protection, thermal protection etc. Mainly the induction motor needs protection from the various of input supply for small motors which is in common use not only in the industry but also in the small scale indstries. The small sacle industries are not able to provide costly protection yo the drives in use as it will increase their capital cost. Hence a cheap and compact design has been done for protection of induction motor againts single phase cut off and thermal protection. Due to the poor power quality the damage of induction motor in small scale industries needs to be taken care of. Many desearches has been done in this area but they are costly and unfeasible in our indian conition. The overall cost of the protection should not be more than 15% of the total cost of the actual machine. Keeping these in mind the design in mind has been proposed used in 8 bit microcontroller, relays, small pts, so the overall cost is low. The efficiency of the protectio should not be compromised.

Keywords- Induction motor,Relay,Temperature sensor, Protection

DESIGN

National Conference on Current Trends in Engineering, Science and Technology (NACCTEST- 2018)
 Organized by GF's Godavari College of Engineering, Jalgaon
International Journal of Innovations in Engineering and Science, Special Conference Issue, 2018
 www.ijies.net

Transformers convert AC electricity from one voltage to another with a little loss of power. Step-up transformers increase voltage, step-down transformers reduce voltage. Most power supplies use a step-down transformer to reduce the dangerously high voltage to a safer low voltage. (LM 7805) The LM78XX/LM78XXA series of three-terminal positive regulators are available in the TO-220/D-PAK package and with several fixed output voltages, making them useful in a Wide range of applications.

tube diodes, mercury arc valves, and other components. The output from the transformer is fed to the rectifier. It converts A.C. into pulsating D.C. In signal processing, a filter is a device or process that removes some unwanted components or features from a signal. Filtering is a class of signal processing, the defining feature of filters being the complete or partial suppression of some aspect of the signal. Light Emitting Diodes (LED) have recently become available that are white and bright, so bright that they seriously compete with incandescent lamps in lighting applications. They are still pretty expensive as compared to a GOW lamp but draw much less current and project a fairly well focused beam. The diode in the photo came with a neat little reflector that tends to sharpen the beam a little but doesn't seem to add much to the overall intensity A resistor is a passive two-terminal electrical component that implements electrical resistance as a circuit element. In electronic circuits, resistors are used to reduce current flow, adjust signal levels, to divide voltages, bias active elements, and terminate transmission lines, among other uses. High-power resistors that can dissipate many watts of electrical power as heat, may be used as part of motor controls, in power distribution systems, or as test loads for generators. Fixed resistors have resistances that only change slightly with temperature, time or operating voltage. Variable resistors can be used to adjust circuit elements (such as a volume control or a lamp dimmer), or as sensing devices for heat, light, humidity, force, or chemical activity. A capacitor or condenser is a passive electronic component consisting of a pair of conductors separated by a dielectric. When a voltage potential difference exists between the conductors, an electric field is present in the dielectric. This field stores energy and produces a mechanical force between the plates. The effect is greatest between wide, flat, parallel, narrowly separated conductors. The LMx39-N series consists of four independent precision voltage comparators with an offset voltage specification as low as 2 mV maximum for all four comparators. These comparators were designed specifically to operate from a single power supply over a wide range of voltages. Operation from split power supplies is also possible and the low power supply current drain is independent of the magnitude of the power supply voltage. These comparators also have a unique characteristic in that the input common-mode voltage range includes ground, even though they are operated from a single power supply voltage. The

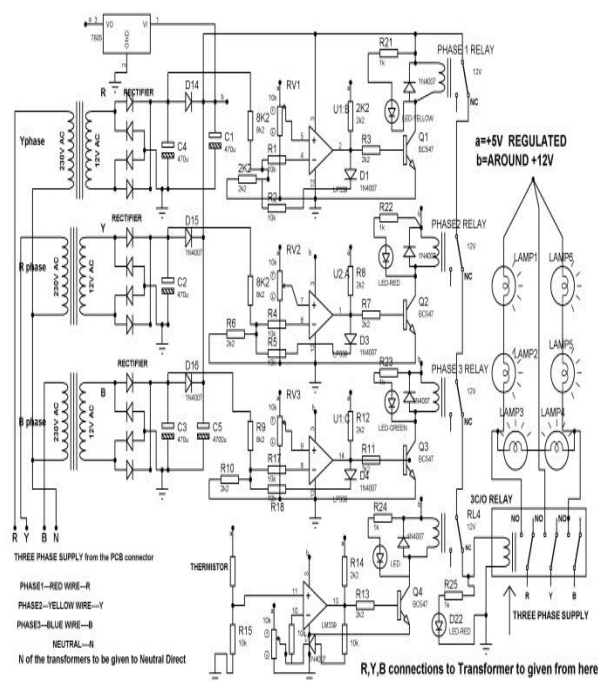

Circuit Diagram

Each type employs internal current limiting, thermal shut-down and safe operating area protection as well as making it essentially indestructible. If sufficient heat sinking is provided, they can deliver over 1A output Current. Even though designed primarily as fixed range of voltage regulators, these devices can be used with external components to obtain adjustable voltages and currents. Secondly rectifier is an electrical device to converts alternating current (AC), which periodically reverses direction, to direct current (DC), current which is unidirectional , a process known as rectification. Rectifiers have many uses including as components of power supplies and as detectors of radio signals. Rectifiers may be made of solid state diodes, vacuum

National Conference on Current Trends in Engineering, Science and Technology (NACCTEST- 2018)
Organized by GF's Godavari College of Engineering, Jalgaon
International Journal of Innovations in Engineering and Science, Special Conference Issue, 2018
www.ijies.net

LMx39-N series was designed to directly interface with TTL and CMOS. When operated from both plus and minus power supplies, the devices directly interface with MOS logic – where the low power drain of the LM339 is a distinct advantage over standard comparators. The main goal of this project is to design an induction motor protection system for guarding the motors from any faults happening from single phasing and over voltage conditions. The induction motor is an essential device in various industrial applications. These motors work on 3-phase supply and a standard temperature to keep the loads at preferred conditions. But; if any phase goes lost or there is a growth in the temperature of the windings it harms the motor. Thus, the proposed system helps to give a protection to the motors in the industries by eliminating the power to the electric motor immediately if any of the phases misses out of the 3-phases, or if the motor's temperature exceeds the threshold value. The proposed system uses 3-phase power supply, where 3 single-phase transformers are allied to it. The project has a set of operational amplifier which is used as comparators for relating input voltages. A thermistor is used to sense the temperature of the induction motor by connecting with the body of the induction motor. This motor is functioned by switching the main relay, which is worked by another set of relays by detecting single phasing & over temperature conditions. In future, this project can be developed by using current sensors and phase-sequence sensor for protecting the overloads and also the motor from applying wrong phase sequence. Induction motor Protection system from single phasing, over voltage, under voltage, overheating and phase reversal provides the smooth running of the induction motor expands its lifetime and also efficiency. Generally, these faults occur when supply system is violating its rating. When the motor is running at rated current, load and voltage then these faults will not be generated. Generally, the smooth running of the motor can be depends on the supply voltage under the set limit & load which is determined by the motor should also be under the stated limit. Therefore, this is all about induction motor protection system project and its working.

CONCLUSION

Induction Motor Protection System is against the single phasing and the high temperature is achieved by simply interrupting the power supply to the load effectively by the uses of comparator – transistors Driven relays Without using microcontroller and other programmable device makes the protection scheme simple and less complex

REFERENCES

1. <http://www.edisontechcenter.org/inductionMotors.html> ;
2. Dr. Yaduvir Singh and Mandhir Verma, 2010“Fundamentals of Electrical Engineering”;
3. <http://www.teslasociety.com/strasbourg.htm>;
4. <http://ieeexplore.ieee.org/stamp/stamp.jsp?arnumber=1454598>;
5. http://197.14.51.10:81/pmb/ELECTRONIQUE/The%20Induction%20Machine%20H%20andbook%20-%200849300045/0004_PDF_C01.pdf
6. <http://www.electricaleasy.com/2014/02/working-principle-and-types-of.html>
7. <http://static.schneiderelectric.us/docs/Circuit%20Protection/0600DB0301.pdf>;
8. <http://www.electrical4u.com/over-current-relay-working-principle-types/>
9. http://www.sayedsaad.com/Protection/files/Over_current/1_Overcurrent.htm;
10. <http://www.maintenancetechnology.com/2004/07/temperature-monitoring-is-keyto-motor-reliability/>
11. <http://ieeexplore.ieee.org/stamp/stamp.jsp?arnumber=1547550>;
12. https://bib.irb.hr/datoteka/779323.2_Brief_Review_of_Motor_Current_Signature_Analysis.pdf
13. <http://www.reliableplant.com/Read/28633/motor-current-signature-analysis>;

National Conference on Current Trends in Engineering, Science and Technology (NACCTEST- 2018)
Organized by GF's Godavari College of Engineering, Jalgaon
International Journal of Innovations in Engineering and Science, Special Conference Issue, 2018
www.ijies.net

GREENER APPROACH FOR MULTICOMPONENT BIGINELLI REACTION USING DISODIUM HYDROGEN PHOSPHATE AS A CATALYST

Harshal Prabhakar Patil¹, Harshal Tukaram Borole², Nilesh Ishwar Patil³, Suryakant Patil⁴

^{1,2,3} PG Students, ⁴ Assistant Professor

^{1,2,3,4} KCE Society's Moolji Jaitha Sr. College, Jalgaon, Maharashtra, India

harshub123@gmail.com

ABSTRACT – The green efficient methods for preparation of Dihydropyrimidone derivatives have been reported in this presentation. Reaction is carried using disodium hydrogen phosphate embedded with SiO₂ as a catalyst under solvent free condition resulting compounds are purified and characterized.

Keywords- Disodium hydrogen phosphate, SiO₂, Dihydropyrimidone.

INTRODUCTION

Dihydropyrimidone were first synthesized by Pitro Biginelli in 1893 using ethyl aceto ester, Aldehyde and Urea. Many new approaches of Dihydropyrimidone synthesized have been reported in past decades like using chiral phosphoric acids, inorganic acid such as zeolite, mesoporous silica and Lewis acid as well as protic acids such as conc.HCl, BF₃, Polyphosphonate ester ⁽¹⁾ FeCl₃/tetra acetyl ortho-silicate, metal bromide, Ionic liquid ⁽²⁾. Dihydropyrimidone shows various biological activities like intriguing therapeutics. Ca-antagonists, vasodilative, Ca- channel modulators and antihypertensive ⁽³⁾. Disodium hydrogen phosphate embedded with SiO₂ shows efficient protocol like high yield. Short reaction time and good recoveribility.

EXPERIMENTAL METHOD

(1)Preparation of catalyst Na₂HPO₄/SiO₂ :

Mixing silica gel (1.5g) with solution Na₂HPO₄ (0.7g) (5mmol) in distilled water (10ml). The mixture was stirred for 30 min to absorb disodium hydrogen phosphate on the surface of silica gel.

After it was dried at 120^oC for 4 to 5 hours the heteropoly acid were prepared.

(2) Preparation of Dihydropyrimidone :

A solution of ethyl acetate (3mmol), Aldehyde (3mmol) and Urea (3mmol) was heated 90^oC under free solvent condition in presence of Na₂HPO₄ (5mol%) the reaction was monitored by TLC. Ethyl acetate (10%) / n-hexane (90%). The reaction mixture was poured in cold water give solid product. The impure product was recrystallized using ethanol solvent (40%). After that MP measured.

REACTION SCHEME

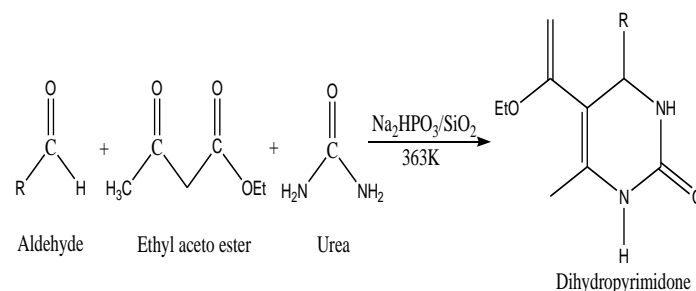

RESULT & DISCUSSION

Result Table:

Sr. No.	Aldehyde	Reaction Time	% Yield	M.P. reported	Literature
1	4-Chloro	3:30	85%	210 ^o C	[209-

National Conference on Current Trends in Engineering, Science and Technology (NACCTEST- 2018)
 Organized by GF's Godavari College of Engineering, Jalgaon
International Journal of Innovations in Engineering and Science, Special Conference Issue, 2018
 www.ijies.net

	benzaldehyde	hrs			211] ⁽¹⁾
2	4-Nitro benzaldehyde	3:00 hrs	82%	204 ⁰ C	[205- 207] ⁽¹⁾
3	Benzaldehyde	4:00 hrs	75%	202 ⁰ C	[201- 203] ⁽¹⁾
4	4-fluro benzaldehyde	2:30 hrs	86%	180 ⁰ C	[180- 182]
5	3-Chloro benzaldehyde	2:45 hrs	81%	190 ⁰ C	[193- 195] ⁽¹⁾

Characterization – I.R. Spectrum:

Compound 1 : 4-Chlorobenzaldehyde

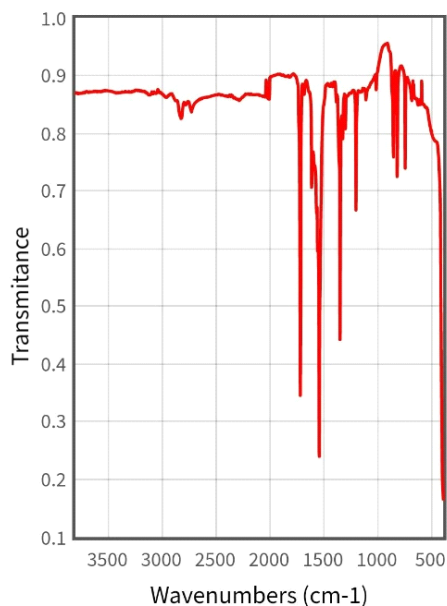

Compound 2 : 4-Nitrobenzaldehyde

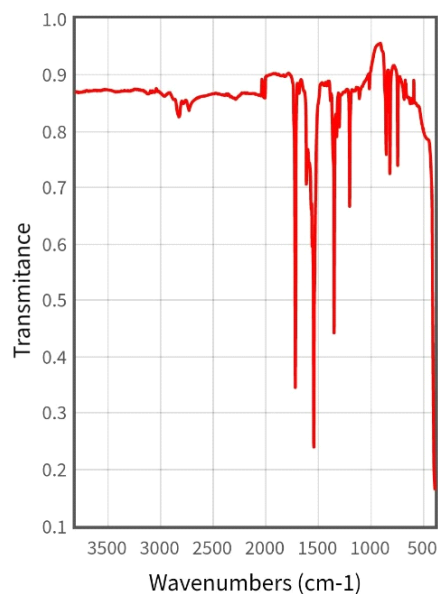

Compound 3 : Benzaldehyde

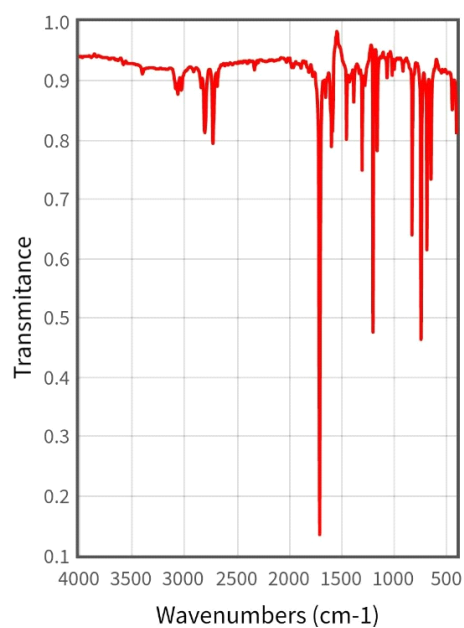

National Conference on Current Trends in Engineering, Science and Technology (NACCTEST- 2018)
 Organized by GF's Godavari College of Engineering, Jalgaon
International Journal of Innovations in Engineering and Science, Special Conference Issue, 2018
 www.ijies.net

Compound 4 : 4-fluorobenzaldehyde

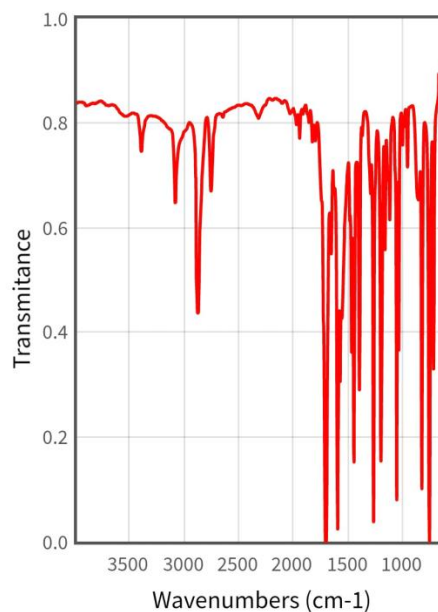
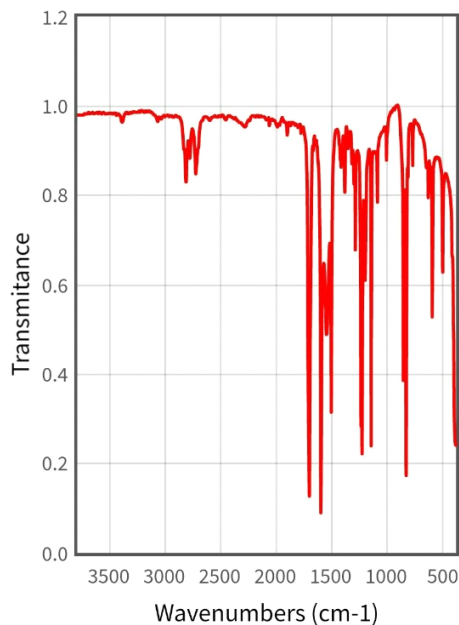

CONCLUSION

1. The method reported is efficient and facial.
2. The catalytic property of Na₂HPO₄ increases by associating with SiO₂.
3. Good yield of the product.
4. Less reaction time.
5. Simple procedure.

Compound 5: 3-Chlorobenzaldehyde

REFERANCES

- [1] Reza Tayebee and et.al.(ammonium Dihydrogen phosphate catalyst for one -pot synthesis of 3,4- Dihydropyrimidine-2(1H)-ones. Chinese Journal of catalysis, 2012, vol.33 no, 659-665.
- [2] N.S. Ghotkar and et.al. (Biginelli synthesis of 3,4-dihydropyrimidine 2 (1H)-one using Layred Double Hydroxide (LDH) as eco-friendly catalyst), Der Pharma Chemica,2015, 7(5):167-172.
- [3] Suresh Patil and Green Approach. Archives at applied science research,2011, 3(1):203-208.

National Conference on Current Trends in Engineering, Science and Technology (NACCTEST- 2018)
Organized by GF's Godavari College of Engineering, Jalgaon
International Journal of Innovations in Engineering and Science, Special Conference Issue, 2018
www.ijies.net

Nano sized ZnO: Synthesis, Characterisation And Gas Sensing

Saroj D. Patil¹, Nitin N. Bhole², R. B. Waghulade³

^{1,2} Applied Science Department, GF's-Godavari College of Engineering, Jalgaon, 425003

³ D.N.C.V.P's Shirish Madhukarrao Chaudhari College, Jalgaon 425001

patilsaroj77@gmail.com

Abstract – This paper reports the synthesis, characterization of nano-sized ZnO. A simple chemical co-precipitation method is used for the synthesis of ZnO nano-sized powder at room temperature. The resulting nano-sized powder was characterized by X-ray diffraction (XRD) measurements, transmission electron microscopy (TEM) and energy dispersive X-ray (EDX). The XRD studies revealed that the nano ZnO have wurtzite structure (hexagonal). The crystalline size was found to be smallest for nano sized ZnO when the as prepared powder was calcinated at 800°C for 2 hr. The H₂S sensing properties of the synthesized nano-sized ZnO were investigated at different operating temperatures and H₂S concentrations. It was found that the operating temperature significantly affect the sensitivity of the nano-sized ZnO powder to the H₂S.

Keywords- Co-precipitation, XRD, TEM, Gas Sensing.

INTRODUCTION

The semiconducting metal oxides such as SnO₂ [1], ZnO [2], WO₃ [3] and Fe₂O₃ [4] have been widely used as gas sensing materials for the detection of inflammable and toxic gases. It was reported that the sensor performance is strongly dependant on the microstructural features such as crystalline size, grain boundary characteristics and thermal stability [5]. Zinc oxide, wide band gap II-VI compound semiconductor, has a stable wurtzite structure with lattice spacing a=0.325 nm and c=0.521 nm. Zinc oxide is on the borderline between a semiconductor and an ionic material [6, 7]. It has attracted intense research effort for its unique properties and versatile applications in transparent electronics, ultraviolet (UV) emitters, piezoelectric devices, chemical sensors and spin electronics [8-17].

EXPERIMENTAL

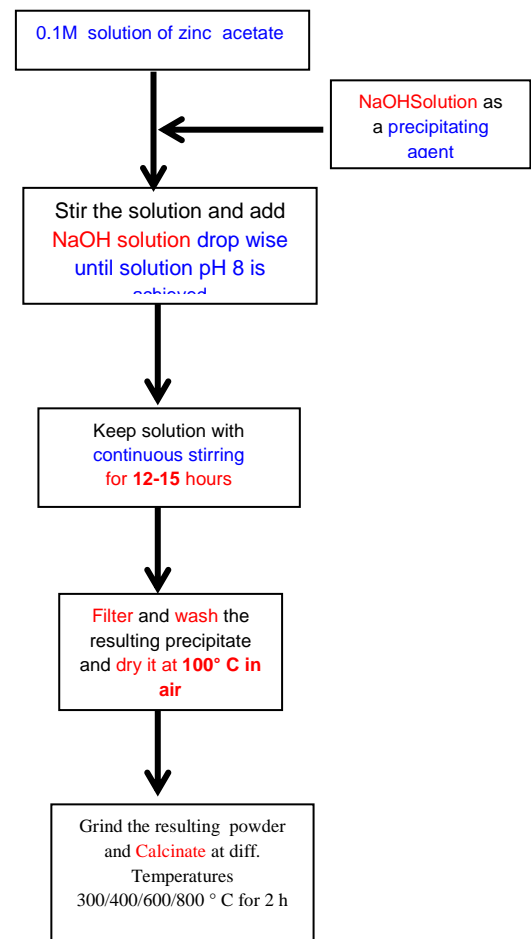
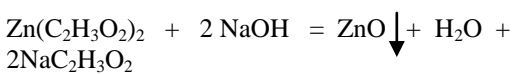

Fig. 1 : A schematic diagram of the synthesis procedure.

The nano-sized powder of ZnO was prepared by a simple co-precipitation method. In this work, the aqueous solution of 0.1 M zinc acetate ($\text{Zn}(\text{C}_2\text{H}_3\text{O}_2)_2$) was prepared in double distilled water. To this solution the

National Conference on Current Trends in Engineering, Science and Technology (NACCTEST- 2018)
Organized by GF's Godavari College of Engineering, Jalgaon
International Journal of Innovations in Engineering and Science, Special Conference Issue, 2018
www.ijies.net

sodium hydroxide was added drop-wise under stirring until the final solution pH value of about 8 was achieved. The resulting precipitate was filtered and washed three to four times using double distilled water to remove impurities. The hydroxide, thus formed was dried at 100°C and grinded into a powder, which is the precursor. The precursor was calcined in air at different temperatures of 400°C, 600°C, 800°C and 1000°C for 2 hours to produce nano-crystalline powders with different grain size. Fig. 1 is a schematic representation of the synthesis procedure. During the calcinations, the as-prepared powder was decomposed as follows –



The structure of calcined powder was investigated by using XRD technique. The XRD pattern was recorded with Xpert MPD diffractometer (Philips, Holland) having Cu K α ($\lambda = 0.1542$ nm). The crystalline size was estimated from the broadening of ZnO (101) diffraction peak ($2\theta = 35.60^\circ$) using Debye-Scherrer's formula. The TEM was used to determine the particle size and the morphology of the nano-sized powder with Tecnai 20 (Philips, Holland). For the conformation of d-values the electron diffraction pattern was recorded. The EDAX analysis proves that the formation of pure ZnO without any impurities.

The gas sensing element of nano ZnO was in the form of pellet and the gas sensing performance was investigated with the help of static gas chamber.

The response (S) of the sensing element is defined as:

$$S(\%) = \frac{R_g - R_a}{R_a} \times 100$$

where R_a and R_g are the resistance values of the sensor element in air and in the presence of gaseous environment.

RESULT AND DISCUSSION

The XRD pattern of the calcined powder at 800°C for 2hr is shown in Fig.2. It indicates the major diffraction peaks at 2θ values of 30.6° , 33.2° , 35.2° , 46.4° , 55.6° , 61.8° and 67.0° etc which are attributed to the formation of ZnO. The peak positions are agreed well with cassiterite structure. The crystalline size was calculated by using Debye-Scherrer's formula –

$$t = \frac{k\lambda}{B \cos \theta}$$

Where, 't' is the average size of the crystallite, assuming that the grains are spherical,

K is 0.9,

λ is the wavelength of X-ray radiation

B is the peak full width at half maximum

And θ is the angle of diffraction.

The crystalline size of the powder calcined at 800°C is found to be minimum and it is ~12.46 nm.

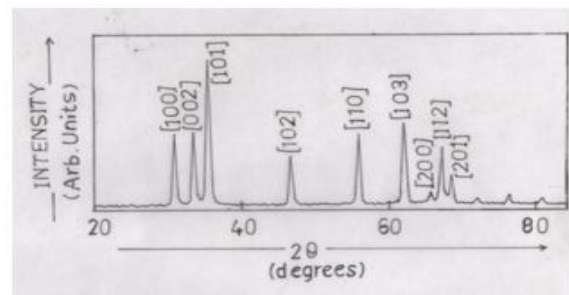

Fig.2: XRD pattern of the ZnO powder calcined at 800°C

The TEM micrograph of the powder calcined at 800°C along with the electron diffraction pattern is as shown in Fig. 3. The TEM micrograph shows clearly that the particle size of powder calcined at 800°C is 12 nm. This result is in well agreement with the crystallite size calculated using the XRD data. The ED pattern gives the d spacing consistent with those obtained from XRD data.

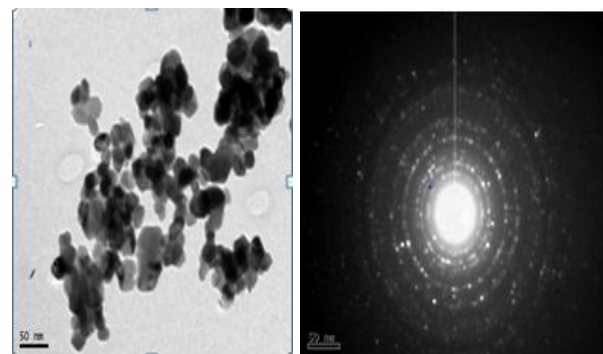

Fig. 3: TEM micrograph with electron diffraction pattern of nano ZnO calcined at 800°C for 2hr.

Hydrogen Sulphide Gas Sensing Performance of nano ZnO:

H₂S is a toxic gas and it is widely generated in nature, for example, in swamps and geothermal sources. H₂S paralyses the olfactory system and, therefore, it is considered more dangerous than CO.

Fig. 5 shows the effect of an operating temperature on the response of nano ZnO and the commercially available ZnO towards H₂S.

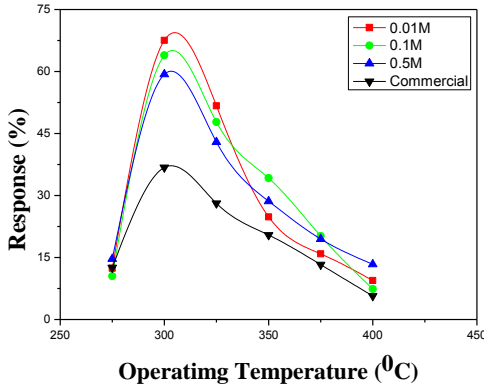

Fig. 5: Effect of operating temperature on response to 2500 ppm of H₂S

It is obvious from Fig. 3.13 that the nano ZnO 0.01M powder exhibits an excellent response to H₂S than a commercially available ZnO. When the commercially available ZnO powder was used, the maximum response to 2500 ppm of H₂S occurs at 300°C and it is 36.78% and the response of the synthesised nano ZnO powder to 2500 ppm of H₂S increases from 12.37% to 67.56% as the operating temperature is raised from 275°C to 300°C and then decreases to 51.68% when the temperature is further raised to 325°C. Thus the response to 2500 ppm of H₂S is maximum at an operating temperature of 300°C and it is found to be ~ 67.56%.

The increased response at 300°C working temperature may be described to the fact that thermal energy acquired by ZnO pellet sensor was sufficiently high to reduce the intergranular potential barrier (Φ_b) and H₂S react to the pellet surface to inject the electrons into conduction band so as to raise the electron concentration substantially [18].

The response and recovery curve of nano ZnO for 2500 ppm of H₂S at operating temperature 300°C are shown in Fig 6. The sample was tested three times. The response time was 13 sec. and the recovery time was 22 sec.

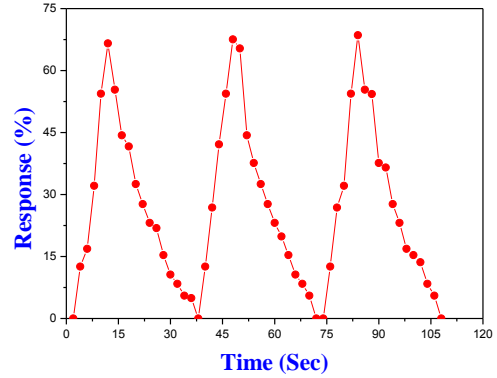

Fig. 6: Response and Recovery curve for nano ZnO at operating temperature 300°C to 2500 ppm of H₂S

The dependence of the response of the synthesized nano ZnO powder on the H₂S concentration at an operating temperature 300°C is shown in Fig. 7.

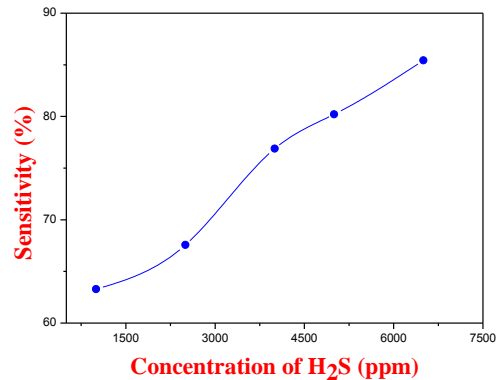

Fig. 7: Dependence of response of nano ZnO on H₂S concentration at operating temperature of 300°C

It is observed that the response increases as the H₂S concentration increases. This relationship between the response and the H₂S concentration may be attributed to the availability of sufficient number of sensing sites on the pellet to act upon the H₂S. It also suggest that the nano sized ZnO can be reliably used to monitor the concentration of H₂S.

CONCLUSION

The following main findings resulted from the present investigation

1. We have successfully synthesised the nano ZnO powder at low cost by using chemical co-precipitation method using zinc acetate and the

National Conference on Current Trends in Engineering, Science and Technology (NACCTEST- 2018)
 Organized by GF's Godavari College of Engineering, Jalgaon
International Journal of Innovations in Engineering and Science, Special Conference Issue, 2018
 www.ijies.net

sodium hydroxide, as starting materials and water as a carrier. The resulting powder was characterised by XRD, TEM.

2. The crystalline size is found to be smallest when the as-prepared powder was calcined at 800⁰C for 2hr and it is ~12.46 nm.
3. The operating temperature significantly affects the sensitivity of the synthesized nano-sized ZnO powder to the H₂S.
4. The results of the H₂S sensing studies reveal that the nano-sized ZnO powder synthesized by a simple co-precipitation method is a suitable material for the fabrication of the H₂S sensor.

REFERENCES

- [1] Y. Sun, X. Huang and J. Liu, *Sensors* 4 (2004) 95.
- [2] A. P. Charatterjee, P. Mitra and A. K. Mukhopadhyay, *J. Mater. Sci.* 34 (1999) 4225.
- [3] M. Stankova, X. Vilanova, E. Liobet, J. Calderer, M. Vinaixa, I. Gracia, C. Cane and X. Correig, *Thin Solid Pelletes* 500 (2006) 302.
- [4] E. T. Lee, G. E.jang, C. K. Kim and D. H. Yoon, *Sens. And Actuators B* 77 (2001) 221.
- [5] M. Egashira and Y. Shimizu, in: N. Yamazoe (Ed.), *Chemical Sensors Technology*, Vol. 3, Kodansha, Tokyo, 1991, pp. 1-17
- [6] Y. Lu, J. Zhong, in: Todd Steiner (Eds) *Semiconductor Nanostructures for Optoelectronic Applications*, Artech House, Inc. Boston, 2004, pp. 187-228.
- [7] P.-C. Chang, Z. Fan, D. Wang, W.-Y. Tseng, W.-A. Chiou, J. Hong, and J.G. Lu, *Chem. Mater.* 16 (2004) 5133-5137.
- [8] K. Nomura, H. Ohta, K. Ueda, T. Kamiya, M. Hirano, H. Hosono, *Science* 300 (2003) 1269-1272.
- [9] T. Nakada, Y. Hirabayashi, T. Tokado, D. Ohmori, T. Mise, *Sol Energy* 77 (2004) 739-747.
- [10] S.Y. Lee, E.S. Shim, H.S. Kang, S.S. Pang, J.S. Kang, *Thin Solid Films* 473 (2005) 31-34.
- [11] R. Könenkamp, R.C. Word, C. Schlegel, *Appl. Phys. Lett.* 85 (2004) 6004-6006.
- [12] S.T. McKinstry, P. Murali, *J. Electroceram.* 12 (2004) 7-17.
- [13] Z.L. Wang, X.Y. Kong, Y. Ding, P. Gao, W.L. Hughes, R. Yang, Y. Zhang, *Adv. Func. Mater.* 14 (2004) 943-956.
- [14] M.S. Wagh, L.A. Patil, T. Seth, D.P. Amalnerkar, *Mater. Chem. Phys.* 84 (2004) 228-233.
- [15] Y. Ushio, M. Miyayama, H. Yanagida, *Sens. Actuat. B* 17 (1994) 221-226.
- [16] H. Harima, *J. Phys.:Condens. Mat.* 16 (2004) S5653-S5660.
- [17] S.J. Pearton, W.H. Heo, M. Ivill, D.P. Norton, T. Steiner, *Semicond. Sci. Technol.* 19 (2004) R59-R74.
- [18] H. Windischmann, P. Mark, *Journal of the Electrochemical Society* 126 (1979) 627.

National Conference on Current Trends in Engineering, Science and Technology (NACCTEST- 2018)
 Organized by GF's Godavari College of Engineering, Jalgaon
International Journal of Innovations in Engineering and Science, Special Conference Issue, 2018
 www.ijies.net

Techniques of pollution control in construction

Patil Lalita B.

*Assistant Professor,
 GF'S Godavari college of Engineering,, Jalgaon
 lalitalalitapatil@rediffmail.com*

Abstract – Construction sector is considered as one of the main sources of environmental pollution in the world. It has massive direct and indirect effects on the environment.

Keywords- Construction, pollution, effects, techniques, control.

INTRODUCTION

Environmental protection is an important issue in developed and developing countries (Tse, 2001). Construction is not an environmentally friendly process by nature (Li et al., 2010). Levin (1997) indicated that building construction and operations have a massive direct and indirect effect on the environment. Ijiga et al. (2013) stated that identifying the impacts of construction project on the environment is a task that needs to be accomplished to realize an effective environmental.

Shen et al. (2005) claimed that construction is a main source of environmental pollution, compared with other industries. Li et al. (2010) agreed with Shen (2005) and maintained that any typical construction process involves using various construction equipment's and natural resources and generates many pollutants. Several writers (Morledge and Jackson, 2001; Ball, 2002; Chen et al., 2004; Lam et al., 2011; Zolfagharian, 2012) summarized these pollutants as noise, air pollution, solid and liquid waste, water pollution, harmful gases, and dust. Furthermore construction projects have become one of the driving forces for the national economy, whose energy consumption, environmental emissions, and social impacts are significant (Chang et al., 2011).

It has been reported that very few contractors and private developers spend efforts in considering the environment and developing the concept of recycling building materials (Lam, 1997), because most of them ranked completion time as their top priority and pay little attention to the environment (Poon et al., 2001).

Most construction projects are located in a densely populated area. Thus, people who live at or close to construction sites are prone to harmful effects on their health because of dust, vibration and noise due to certain construction activities such as excavation and pile driving (Li et al., 2010). During the construction phase of a project, construction dust and noise are regarded to be two major factors that affect human health (Tam et al., 2004). Li et al. (2010) and Zolfagharian et al. (2012)

IMPACTS OF CONSTRUCTION

The main impacts experienced during the construction of the project are given in detail below

Noise:

- Noise was felt to be particularly bad during demolition and the early stages eg. pile driving, drilling, hammering
- Noise was caused by extra traffic, lorries, heavy machinery and engines.
- Local residents kept windows closed at all times.

Vibration:

- Damage occurred to houses eg cracking occurs to walls, plaster
- People were stressed by vibration from demolition and drilling at the same time.

Pollution:

- Residents were worried about pollution, eg asbestos dust from the site coming into homes.

Dust:

- Homes were covered in the dust both inside and outside, particularly in summer. Windows curtains and bed clothes were covered in dust even when the windows were closed.
- Plants and gardens were damaged.
- Children could not play outside for many months. This was problematic particular in the summer.

National Conference on Current Trends in Engineering, Science and Technology (NACCTEST- 2018)
 Organized by GF's Godavari College of Engineering, Jalgaon
International Journal of Innovations in Engineering and Science, Special Conference Issue, 2018
 www.ijies.net

- Large piles of crushed concrete etc were left on sites. These blew around in the wind particularly in dry weather.
- Health problems particularly asthma bronchitis , conjunctivities and coughing were aggravated.

TECHNIQUES:

Following are the techniques used for controlling pollution in construction.

1. Prefabricating Materials in Controlled Environments
2. Construction Waste Management
3. Managing the Site for Improved Environment
4. Lean Manufacturing to Reduce Energy
5. Material Selection

CONCLUSION

Building waste often includes concrete, metals, glass, plastics, wood, asphalt, bricks and more. This waste is often disposed of in either landfills or incinerators. Not only does this pollute the land and the air, but the transportation required to remove such waste has a major impact on the environment. Following precautions should be take on site for controlling pollution.

- Keep dust down by spraying appropriate areas of the site with water from time to time, especially during dry weather.
- Keep access roads clean, and when necessary, use wheel washers for vehicles leaving the site.
- Cover wagons and loaded skips in order to minimise dust emissions and dirtying of local roads during transportation.
- Do not burn waste! Make proper arrangements for removal of waste from site and its disposal.

REFERENCES

- [1] Morledge R. and Jackson F. (2001), *Reducing environmental pollution caused by construction plant. Environmental Management and Health, 12(2): 191-206.*
- [2] Levin H. (1997), *Systematic evaluation and assessment of building environmental performance (SEABEP), paper for presentation to "Buildings and Environment", Paris, 9-12 June, 1997.*
- [3] Li X., Zhu Y. and Zhang Z. (2010), An LCA-based environmental impact assessment model for construction processes. *Building and Environment, 45(3):766-775.*
- [4] Morledge R. and Jackson F. (2001), *Reducing environmental pollution caused by construction plant. Environmental Management and Health, 12(2): 191-206.*
- [5] *Manchester city council*



KEY FEATURES

Affiliated to Dr. Babasaheb Ambedkar Technological University, (B-Tech) Lonere (Dr. BATU)

Centrally Located only Institute in industrial zone in jalgaon City

Excellent placement and Job Guarantee, Personality Development, Soft Skill Development for Students

Wi-Fi Green Campus & Air Conditioned Library with 24x7 Reading Facility

Conferences, Seminars, Project competitions for overall development of students

Excellent Sport Facility, GYM and Extracurricular Activities for students

Godavari Foundation's

GODAVARI COLLEGE OF ENGINEERING

P-51, ADD. MIDC, BHUSAWAL ROAD, JALGAON-425003 (M.S.)

•0257-2212999, 2213500 • gcoe1999@gmail.com • www.godavaricoejal.ac.in



A Tradition of Excellence !